



Level



Pressure



Flow



Temperature



Liquid
Analysis



Registration



Systems
Components



Services



Solutions

Description of Instrument Functions

Prosonic M FMU40/41/42/43/44 with HART, PROFIBUS-PA and FOUNDATION Fieldbus

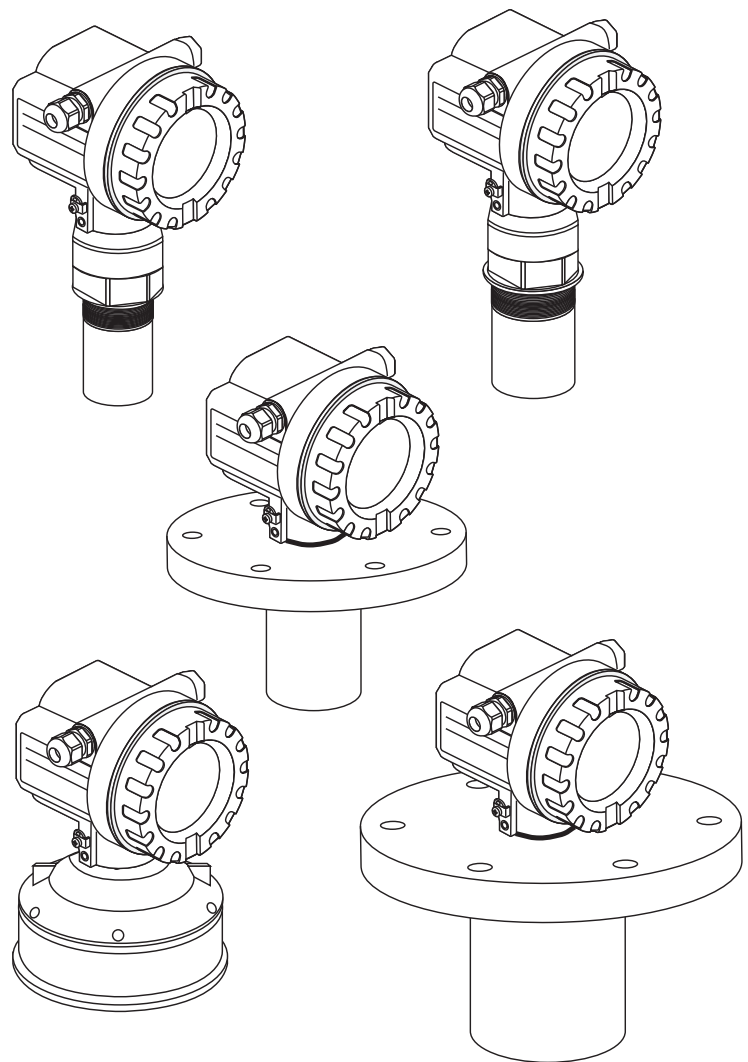

BA00240F/00/EN/13.12
71164400

Valid as of software version:
V 01.04.00 (amplifier)
V 01.04.00 (communication)

Short instructions

KA 183F/00/a2/02.02
52010993

Prosonic M - Quick Setup

⚠ Contrast: E + + or E + -

000 measured value

Group selection

- 00 basic setup
- 01 safety settings
- 0E temperature
- 04 linearisation
- 05 extended calibr.
- 06 output (HART, FF) profibus param.(PA)
- 0E Envelope curve
- 09 display
- 0A diagnostics
- 0C system parameter

002 tank shape

- dome ceiling
- horizontal cyl.
- bypass
- ...

003 medium property

- unknown
- liquid
- > 4 mm
- < 4 mm
- ...

004 process cond.

- standard
- calm surface
- add. agitator
- ...

005 empty calibr.

input E (s. sketch)

006 full calibr.

input F (s. sketch)

008 dist./meas value

D and L are displayed (s. sketch)

051 check distance

- ok
- too small
- too big
- unknown
- manual

052 range of mapping

confirm suggestion or specify range

053 start mapping

BD: blocking distance

008 dist./meas value

009 recording curve

0A3 reset

333 (HART) 33333 (PA,FF)

0A4 unlock parameter

100 (HART) 2457 (PA,FF)

52010993

Contents of the operating instructions

This operating instructions contain all functions off the Prosonic M operating menu. All types of devices (FMU40/41/42/43/44) and all communication variants are considered.

Information on mounting, wiring, trouble shooting and maintenance can be found in the following documents. These documents can be found on the CD-ROM "Device Desriptions + Documentation".

- BA00237F/00/EN (HART)
- BA00238F/00/EN (PROFIBUS PA)
- BA00239F/00/EN (FOUNDATION Fieldbus)

1	Notes on use	5	8.2	Function "instrument addr." (060), PROFIBUS-PA only	49
1.1	Using the table of contents to locate a function description	5	8.4	Function "ident number" (061), PROFIBUS-PA only	50
1.2	Using the graphic of the function menu to locate a function description	5	8.6	Function "set unit to bus" (062), PROFIBUS-PA only .	51
1.3	Using the index of the function menu to locate a function description	5	8.8	Function "out value" (063), PROFIBUS-PA only ...	52
2	Function menu Prosonic M	13	8.10	Function "out status" (064), PROFIBUS-PA only ...	53
3	Function group "basic setup" (00) ...	17	8.12	Function "simulation value" (066)	55
3.1	Function "measured value" (000)	17	8.14	Function "2nd cyclic value" (067), PROFIBUS-PA only	56
3.2	Function "tank shape" (002)	17	8.15	Function "4mA-value" (068), HART only	56
3.4	Function "process cond." (004)	18	8.17	Function "20mA-value" (069), HART only	57
3.6	Function "blocking dist." (059)	20	8.18	Function "display value" (069), PROFIBUS-PA only	57
3.8	Display (008)	21	9	Function group "Envelope curve" (0E)	59
3.10	Function "range of mapping" (052)	23	9.1	Function "plot settings" (0E1)	59
3.11	Funktion "start mapping" (053)	23	9.2	Function "recording curve" (0E2)	59
4	Function group "safety settings" (01).	25	10	Function group "display" (09)	63
4.1	Function "output on alarm" (010)	25	10.1	Function "language" (092)	63
4.3	Function "outp. echo loss" (012)	27	10.2	Function "back to home" (093)	63
4.4	Function "ramp %span/min" (013)	28	10.4	Function "no.of decimals" (095)	64
4.6	Function "safety distance" (015)	29	10.5	Function "sep. character" (096)	64
5	Function group "temperature" (03) ..	33	10.6	Function "display test" (097)	65
5.1	Function "measured temp." (030)	33	11	Function group "diagnostics" (0A) ...	67
5.2	Function "max. temp. limit" (031)	33	11.2	Function "previous error" (0A1)	68
5.3	Function "max. meas. temp." (032)	33	11.3	Function "clear last error" (0A2)	68
5.5	Function "defect temp. sens." (034)	34	11.6	Function "measured dist." (0A5)	72
6	Function group "linearisation" (04) ..	35	11.8	Function "detection window" (0A7) (from Software 01.04.00)	73
6.1	Function "level/ullage" (040)	35	12	Function group "system parameters" (0C)	75
6.5	Function "input level" (044)	41	12.1	Function "tag no." (0C0)	75
6.7	Function "max. scale" (046)	42	12.2	Function "device tag" (0C0), FOUNDATION Fieldbus only	75
6.8	Function "diameter vessel" (047)	42	12.3	Function "Profile Version" (0C1), PROFIBUS-PA only	75
7	Function group "extended calibr." (05).	43	12.4	Function "protocol+sw-no." (0C2)	75
7.1	Function "selection" (050)	43	12.6	Function "device id" (0C4), FOUNDATION Fieldbus only	76
7.2	Function "check distance" (051)	43	12.7	Function "distance unit" (0C5)	76
7.3	Function "range of mapping" (052)	44	12.9	Function "download mode" (0C8)	77
7.4	Function "start mapping" (053)	44	13	Function group "service" (0D)	79
7.5	Function "pres. map dist." (054)	45	13.1	Software history	79
7.7	Function "echo quality" (056)	46	14	Signal evaluation	81
7.8	Function "offset" (057)	47	14.1	Envelope curve	81
7.9	Function "output damping" (058)	47	15	Trouble shooting	85
7.10	Function "blocking dist." (059)	47	15.1	System error messages	85
8	Function group "output" (06), - "profibus param." (06), PROFIBUS-PA only	49			
8.1	Function "commun. address" (060), HART only ...	49			

1 Notes on use

You have various options for accessing the descriptions of instrument functions or how to enter parameters.

1.1 Using the table of contents to locate a function description

All the functions are listed in the table of contents sorted by function group (e.g. basic setup, safety settings, etc.). You can access a more detailed description of a function by using a page reference / link.

The table of contents is on →  3.

1.2 Using the graphic of the function menu to locate a function description

This guides you step by step from the highest level, the function groups, to the exact function description you require.

All the available function groups and instrument functions are listed in the table (→  13). Select your required function group or function. You can access an exact description of the function group or function by using a page reference.

1.3 Using the index of the function menu to locate a function description

To simplify navigation within the function menu, each function has a position which is shown in the display. You can access each function via a page reference in the function menu index (→  91) which lists all the function names alphabetically and numerically.

1.4 General structure of the operating menu

The operating menu is made up of two levels:

■ **Function groups (00, 01, 03, ..., 0C, 0D):**

The individual operating Selection of the instrument are split up roughly into different function groups. The function groups that are available include, e.g.: **"basic setup"**, **"safety settings"**, **"output"**, **"display"**, etc.

■ **Functions (001, 002, 003, ..., 0D8, 0D9):**

Each function group consists of one or more functions. The functions perform the actual operation or parameterisation of the instrument. Numerical values can be entered here and parameters can be selected and saved. The available functions of the **"basic setup (00)"** function group include, e.g.: **"tank shape (002)"**, **"medium property (003)"**, **"process cond. (004)"**, **"empty calibr. (005)"**, etc.

If, for example, the application of the instrument is to be changed, carry out the following procedure:

1. Select the **"basic setup (00)"** function group.
2. Select the **"tank shape (002)"** function (where the existing tank shape is selected).

1.4.1 Identifying the functions

For simple orientation within the function menus (→ 13), for each function a position is shown on the display.

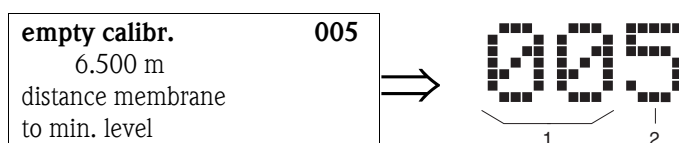

- 1 Function group
- 2 Function

The first two digits identify the function group:

- **basic setup** 00
- **safety settings** 01
- **temperature** 03
- ...

The third digit numbers the individual functions within the function group:

- **basic setup** 00 → ■ **tank shape** 002
- **medium property** 003
- **process cond.** 004
- ...

Hereafter the position is always given in brackets (e.g. **"tank shape" (002)**) after the described function.

1.5 Display and operating elements

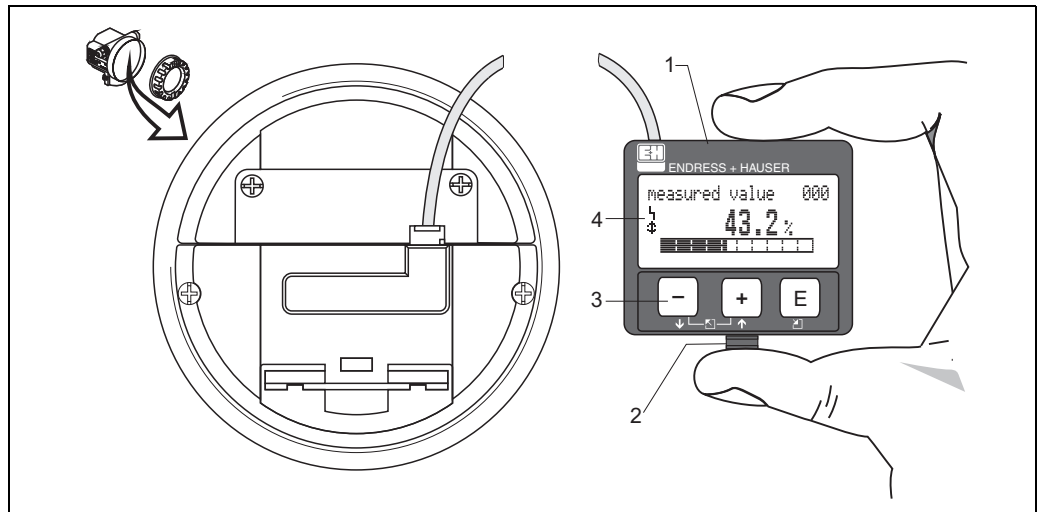

100-FMxxxxx-07-00-00-yy-001

- 1 LCD liquid crystal display
- 2 Snap fit
- 3 Keys
- 4 Symbols

1.5.1 Display



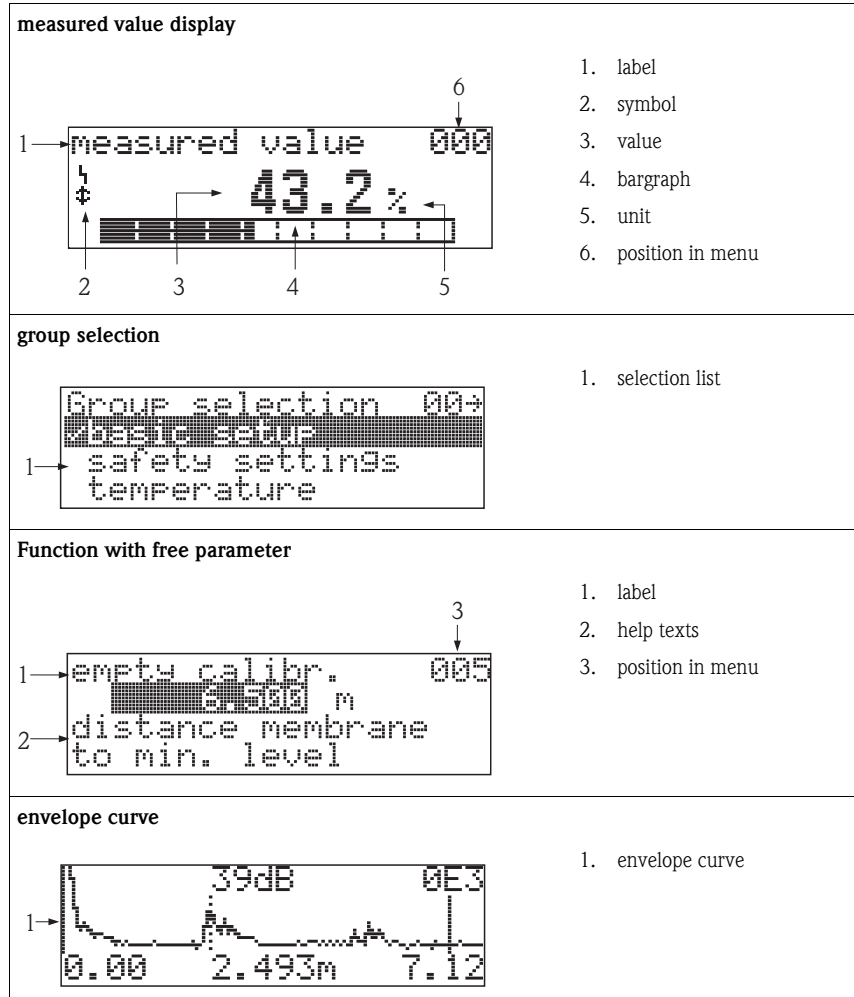

Liquid crystal display (LCD):

Four lines with 20 characters each. Display contrast adjustable through key combination.



1.5.2 Display symbols













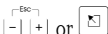

The following table describes the symbols that appear on the liquid crystal display:

Symbols	Meaning
	ALARM_SYMBOL This alarm symbol appears when the instrument is in an alarm state. If the symbol flashes, this indicates a warning.
	LOCK_SYMBOL This lock symbol appears when the instrument is locked, i.e. if no input is possible.
	COM_SYMBOL This communication symbol appears when a data transmission via e.g. HART, PROFIBUS-PA or FOUNDATION Fieldbus is in progress.
	SIMULATION_SWITCH_ENABLE This communication symbol appears when simulation in FF is enabled via the DIP switch.

1.5.3 Key assignment

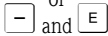
The operating elements are located inside the housing and are accessible for operation by opening the lid of the housing.

Function of the keys

Key(s)	Meaning
 or 	Navigate upwards in the selection list Edit numeric value within a function
 or 	Navigate downwards in the selection list Edit numeric value within a function
 or 	Navigate to the left within a function group
 or 	Navigate to the right within a function group, confirmation.
 and  or  and 	Contrast settings of the LCD
 and  and 	Hardware lock / unlock After a hardware lock, an operation of the instrument via display or communication is not possible! The hardware can only be unlocked via the display. An unlock parameter must be entered to do so.

1.5.4 Operation with the VU331

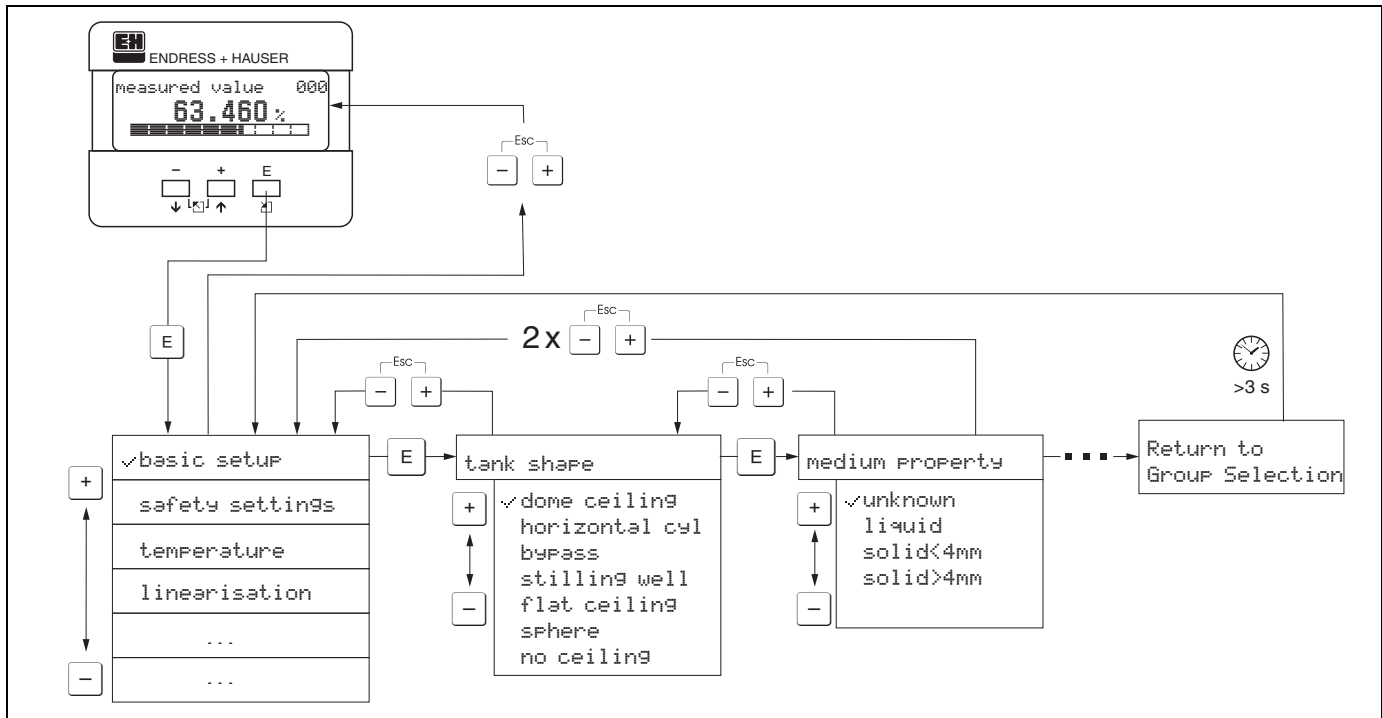

1. Change from Measured Value Display to **Group Selection** by pressing **E**.
2. Press **-** or **+** to select the required **Function Group** and confirm by pressing **E**.
Note!The active selection is marked by a ✓ in front of the menu text.
3. Activate Edit mode with **+** or **-**.

Selection menus

- a) Select the required Parameter in selected function with **-** oder **+**.
- b) **E** confirms selection; ✓ appears in front of the selected parameter.
- c) **E** confirms the edited value; system quits edit mode.
- d) **+** and **-** (= **↵**) interrupts selection; system quits edit mode.

Typing in numerals and text

- a) Press **+** or **-** to edit the first character of the numeral / text.
 - b) **E** positions the cursor at the next character; continue with a. until you have completed your input.
 - c) If a **↵** symbol appears at the cursor, press **E** to accept the value entered; system quits edit mode.
 - d) If a **←** symbol appears at the cursor, press **E** to return to the previous character (e.g. for correction of entries).
 - e) **+** and **-** (= **↵**) interrupts selection; system quits edit mode.
4. Press **E** to select the next **function**.
 5. Press **+** and **-** (= **↵**) once; return to previous **function**.
Press **+** and **-** (= **↵**) twice; return to **Group Selection**.
 6. Press **+** and **-** (= **↵**) to return to **Measured value display**.

1.6 Commissioning

1.6.1 Switching on the measuring device

After switching on the supply voltage, the instrument is first initialised.
Then the following appear for approximately five seconds:

- Device type
- Software version

Press E to exit this display.

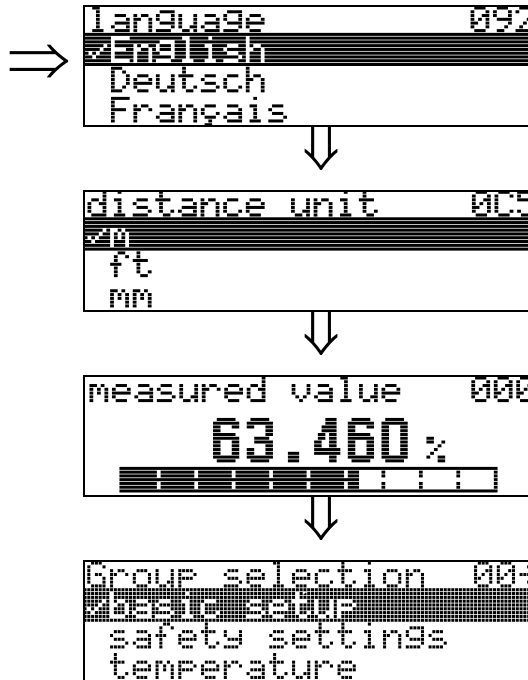

Select the language
(this message appears the first time the instrument is switched on)

Select the basic unit
(this message appears the first time the instrument is switched on)

The current measured value is displayed

After **E** is pressed, you reach the group selection.

This selection enables you to perform the basic setup

2 Function menu Prosonic M

Function group	Function	Description
basic setup 00 (see Page 17) ↓	measured value 000 →	Page 17
	tank shape 002 →	Page 17
	medium property 003 →	Page 18
	process cond. 004 →	Page 18
	empty calibr. 005 →	Page 20
	blocking dist. 059 →	Page 20
	full calibr. 006 →	Page 21
	display 008 →	Page 21
	check distance 051 →	Page 22
	range of mapping 052 →	Page 23
	start mapping 053 →	Page 23
	display 008 →	Page 24
	safety settings 01 (see Page 25) ↓	output on alarm 010 →
output on alarm (HART only) 011 →		Page 27
outp. echo loss 012 →		Page 27
ramp %span/min 013 →		Page 28
delay time 014 →		Page 29
safety distance 015 →		Page 29
in safety dist. 016 →		Page 30
ackn. alarm 017 →		Page 32
temperature 03 (see Page 33) ↓	measured temp. 030 →	Page 33
	max. temp. limit 031 →	Page 33
	max. meas. temp. 032 →	Page 33
	react high temp. 033 →	Page 34
	defect temp. sens. 034 →	Page 34
linearisation 04 (see Page 35) ↓	level/ullage 040 →	Page 35
	linearisation 041 →	Page 36
	customer unit 042 →	Page 40
	table no. 043 →	Page 41
	input level 044 →	Page 41
	input volume 045 →	Page 42
	max. scale 046 →	Page 42
	diameter vessel 047 →	Page 42
extended calibr. 05 (see Page 43) ↓	selection 050 →	Page 43
	check distance 051 →	Page 43
	range of mapping 052 →	Page 44
	start mapping 053 →	Page 44
	pres. map dist. 054 →	Page 45
	cust. tank map 055 →	Page 46
	echo quality 056 →	Page 46
	offset 057 →	Page 47
	output damping 058 →	Page 47
	blocking dist. 059 →	Page 47

Function group	Function	Description
output 06 profibus param. 06 PROFIBUS-PA only (see Page 49) ↓	⇒ commun. address (HART only) 060 →	Page 49
	⇒ instrument addr. (PROFIBUS-PA only) 060 →	Page 49
	⇒ no. of preambels (HART only) 061 →	Page 50
	⇒ ident number (PROFIBUS-PA only) 061 →	Page 50
	⇒ thres. main val. (HART only) 062 →	Page 51
	⇒ set unit to bus (PROFIBUS-PA only) 062 →	Page 51
	⇒ current output mode (HART only) 063 →	Page 52
	⇒ out value (PROFIBUS-PA only) 063 →	Page 52
	⇒ fixed cur. value (HART only) 064 →	Page 53
	⇒ out status (PROFIBUS-PA only) 064 →	Page 53
	⇒ simulation 065 →	Page 54
	⇒ simulation value 066 →	Page 55
	⇒ output current (HART only) 067 →	Page 56
	⇒ 2nd cyclic value (PROFIBUS-PA only) 067 →	Page 56
	⇒ 4 mA value (HART only) 068 →	Page 56
	⇒ select v0h0 (PROFIBUS-PA only) 068 →	Page 57
	⇒ 20 mA value (HART only) 068 →	Page 57
	⇒ display value (PROFIBUS-PA only) 069 →	Page 57
envelope 0E (see Page 59) ↓	⇒ plot settings 0E1 →	Page 59
	⇒ recording curve 0E2 →	Page 59
	⇒ envelope curve display 0E3 →	Page 60
display 09 (see Page 63) ↓	⇒ language 092 →	Page 63
	⇒ back to home 093 →	Page 63
	⇒ format display 094 →	Page 64
	⇒ no.of decimals 095 →	Page 64
	⇒ sep. character 096 →	Page 64
	⇒ display test 097 →	Page 65
diagnostics 0A (see Page 67) ↓	⇒ present error 0A0 →	Page 68
	⇒ previous error 0A1 →	Page 68
	⇒ clear last error 0A2 →	Page 68
	⇒ reset 0A3 →	Page 69
	⇒ unlock parameter 0A4 →	Page 71
	⇒ measured dist. 0A5 →	Page 72
	⇒ measured level 0A6 →	Page 73
	⇒ detection window 0A7 →	Page 73
	⇒ application par. 0A8 →	Page 74

system parameter 0C (see Page 75) ↓	⇒	tag no.	0C0	→	Page 75
		device tag (FOUNDATION Fieldbus only)	0C0	→	Page 75
		Profile Version (PROFIBUS-PA only)	0C1	→	Page 75
		protocol+sw-no.	0C2	→	Page 75
		serial no.	0C4	→	Page 76
		device id (FOUNDATION Fieldbus only)	0C4	→	Page 76
		distance unit	0C5	→	Page 76
		temperature unit	0C6	→	Page 77
		download mode	0C8	→	Page 77
service D00	⇒	service level	D00		Page 79

3 Function group "basic setup" (00)

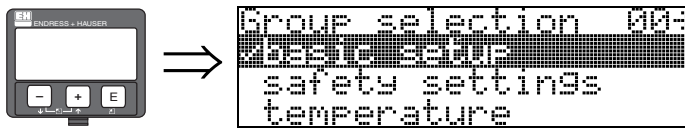

3.1 Function "measured value" (000)



This function displays the current measured value in the selected unit (see "customer unit" (042) function). The number of places after decimal point can be selected in the "no.of decimals" (095) function.

3.2 Function "tank shape" (002)

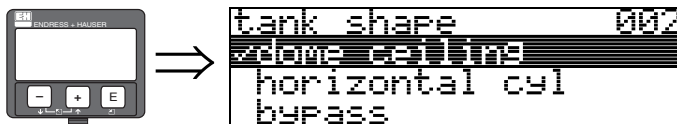

This function is used to select the tank shape.

Selection

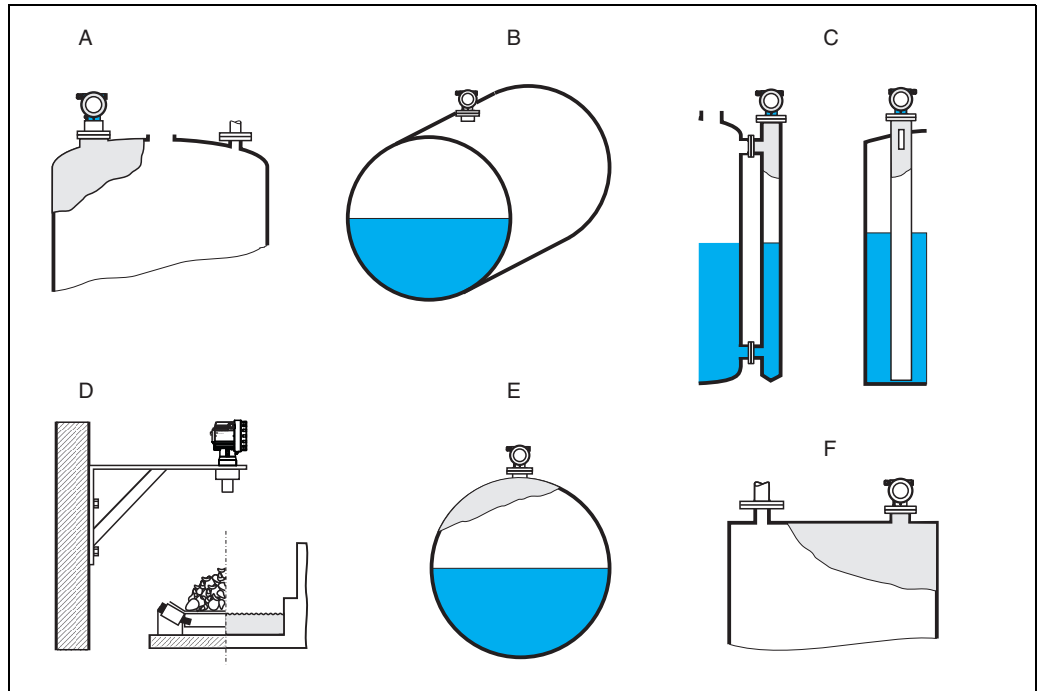

- A: dome ceiling
- B: horizontal cyl.
- C: bypass, stilling well/ultrasonic guide pipe
- D: no ceiling, e.g. dumps, open levels, chanel, weirs
- E: sphere
- F: flat ceiling

3.3 Function "medium property" (003)

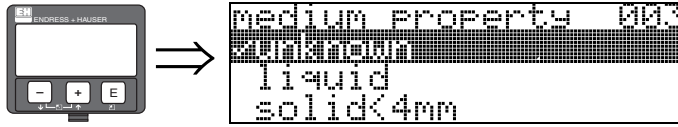

This function is used to set the medium properties:

- **unknown** (e.g. pasty media such as greases, creams, gels etc.)
- liquid
- solid, grain size < 4mm (fine)
- solid, grain size > 4mm (coarse)

3.4 Function "process cond." (004)

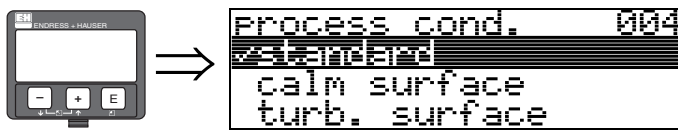

This function is used to select the process conditions.

Selection:

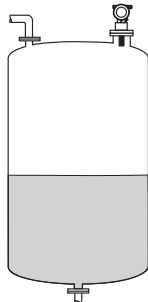
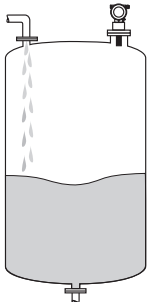
standard liquids	calm surface	turb. surface
For all fluid applications which do not fit in any of the following groups.	Storage tanks with immersion tube or bottom filling	Storage / accumulation tanks with uneven surface due to free filling, mixing nozzles or small bottom stirrers
		
The filters and output damping are set to average values.	The averaging filters and output damping are set to large values. -> Stable measured value -> Accurate measurement -> Slow reaction time	Special filters for stabilising the input signal are activated. -> Stable measured value -> Medium reaction time

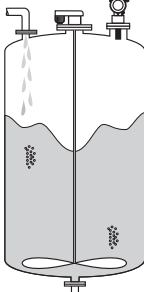
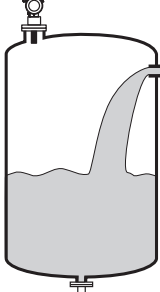
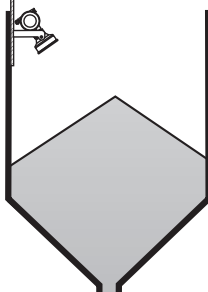
add. agitator	fast change	standard solid
Moving surfaces (poss. with vortex formation) due to agitators	Rapid level change, particularly in small tanks	For all bulk solids applications which do not fit in any of the following groups.
		
Special filters for stabilising the input signal are set to large values. -> Stable measured value -> Medium reaction time	The averaging filters are set to small values. -> Rapid reaction time -> Possibly unstable measured value	The filter and output damping are set to average values.

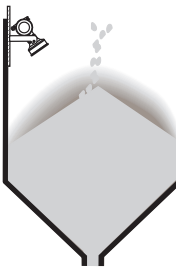
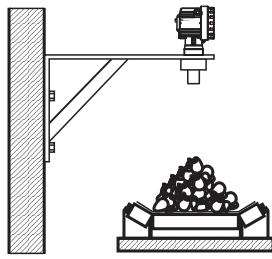
solid dusty	conveyor belt	Test: no filter
Dusty bulk solids	Bulk solids with rapid level change	All the filters can be switched off for purposes of service and diagnosis.
		
The filters are set to detect even relatively weak signals.	The averaging filters are set to small values. -> Rapid reaction time -> Possibly unstable measured value	All filters off

3.5 Function "empty calibr." (005)

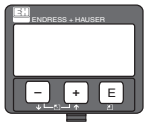

```
empty calibr. 005  
[██████████] m  
distance membrane  
to min. level
```

This function is used to enter the distance from the sensor membrane (reference point of the measurement) to the minimum level (=zero).

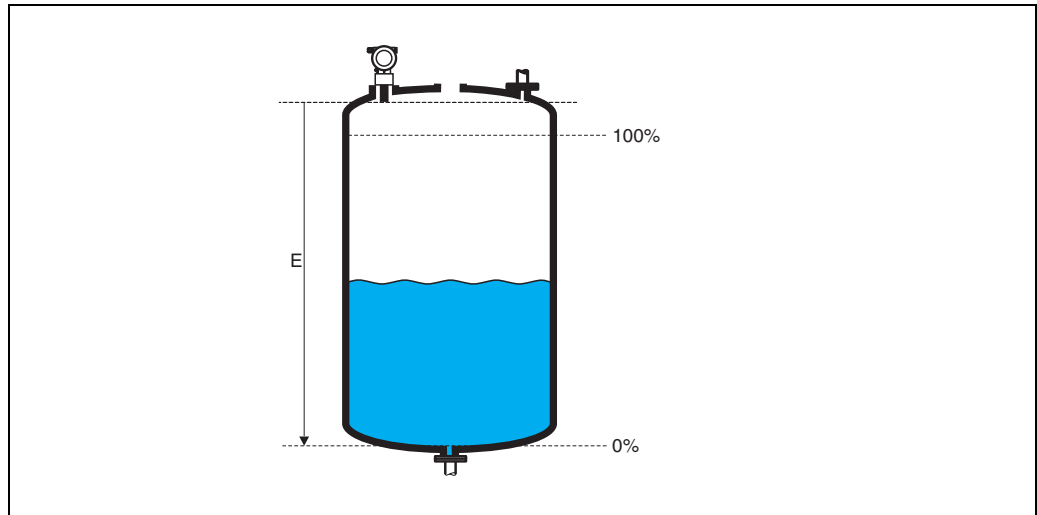

E: empty calibration



Caution!

For dish bottoms or conical outlets, the zero point should be no lower than the point at which the radar beam hits the bottom of the tank.

3.6 Function "blocking dist." (059)



```
blocking dist. 059  
[██████████] m  
BD=blocking dist.
```

In this function the blocking distance is displayed. Level echoes within the blocking distance can not be detected by the Prosonic M. Make sure that the maximum level will never run into the blocking distance.

3.7 Function "full calibr." (006)



This function is used to enter the distance from the minimum level to the maximum level (=span).

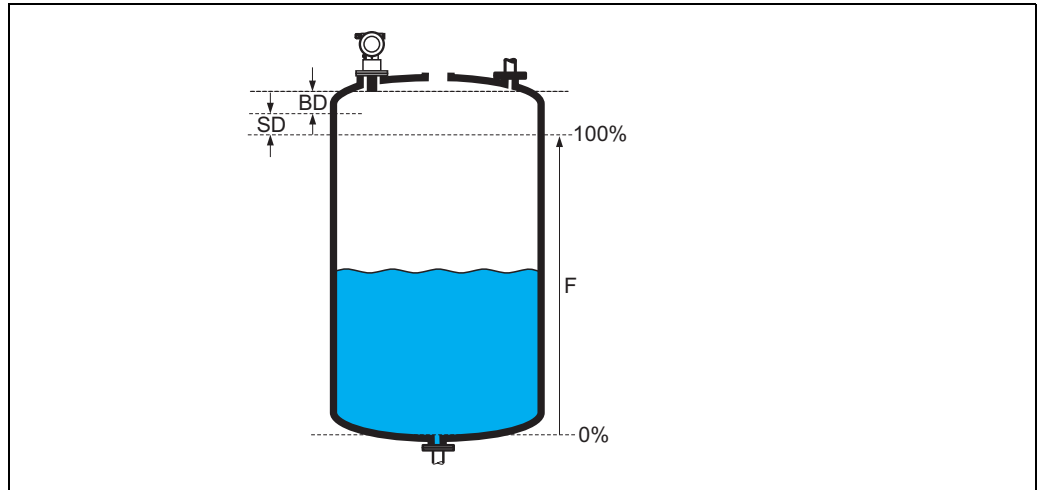

F: full calibration (span); BD: blocking distance; SD: safety distance



Caution!

The maximum level may not project into the blocking distance (BD). If the blocking distance is compromised, it may cause device malfunction.

After basic calibration, enter a safety distance (SD) in the "**safety distance**" (015) function. If the level is within this safety distance, the Prosonic M signals a warning or an alarm, depending on your selection in the "**in safety distance**" (016) function.

3.8 Display (008)

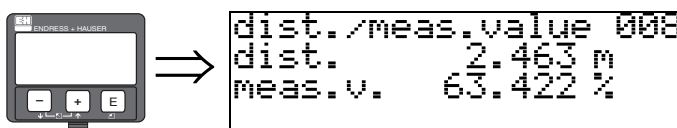

The **distance** measured from the sensor membrane to the product surface and the **level** calculated with the aid of the empty calibration are displayed. Check whether the values correspond to the actual level or the actual distance. The following cases can occur:

- Distance correct – level correct -> continue with the next function, "**check distance**" (051)
- Distance correct – level incorrect -> Check "**empty calibr.**" (005)
- Distance incorrect – level incorrect -> continue with the next function, "**check distance**" (051)

3.9 Function "check distance" (051)



This function triggers the mapping of interference echoes. To do so, the measured distance must be compared with the actual distance to the product surface. The following options are available for selection:

Selection:

- distance = ok
- dist. too small
- dist. too big
- **dist. unknown**
- manual

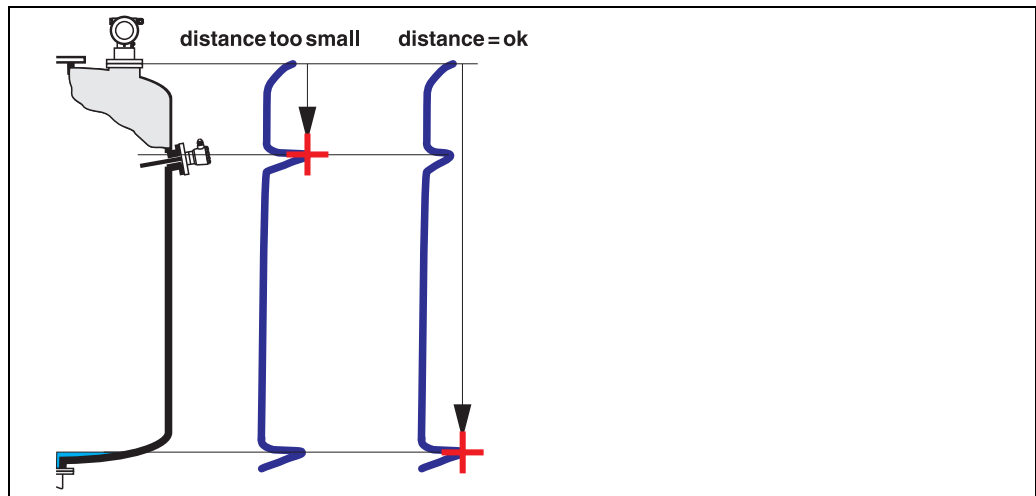

distance = ok

- mapping is carried out up to the currently measured echo
- The range to be suppressed is suggested in the "**range of mapping (052)**" function. Anyway, it is wise to carry out a mapping even in this case.

dist. too small

- At the moment, an interference is being evaluated
- Therefore, a mapping is carried out including the presently measured echoes
- The range to be suppressed is suggested in the "**range of mapping (052)**" function

dist. too big

- This error cannot be remedied by interference echo mapping
- Check the application parameters **(002)**, **(003)**, **(004)** and "**empty calibr.**" **(005)**

dist. unknown

If the actual distance is not known, no mapping can be carried out.

manual

A mapping is also possible by manual entry of the range to be suppressed. This entry is made in the "**range of mapping (052)**" function.



Caution!

The range of mapping must end 0.5 m (1.6 ft) before the echo of the actual level. For an empty tank, do not enter E, but E - 0.5 m (1.6 ft).

3.10 Function "range of mapping" (052)



This function displays the suggested range of mapping. The reference point is always the sensor membrane. This value can be edited by the operator. For manual mapping, the default value is: 0 m.

3.11 Funktion "start mapping" (053)



This function is used to start the interference echo mapping up to the distance given in "**range of mapping**" (052).

Selection:

- **off:** no mapping is carried out
- **on:** mapping is started



Note!

If a mapping already exists, it is overwritten up to the distance specified in "**range of mapping**" (052). Beyond this value the existing mapping remains unchanged.

3.12 Display (008)

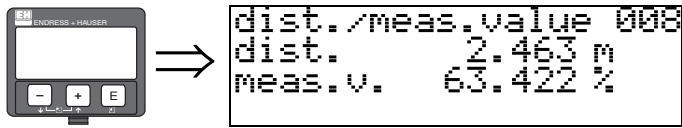

The distance measured from the reference point to the product surface and the level calculated with the aid of the empty alignment are displayed again. Check whether the values correspond to the actual level or the actual distance. The following cases can occur:

- Distance correct – level correct -> basic setup completed
- Distance incorrect – level incorrect -> a further interference echo mapping must be carried out "**check distance**" (051).
- Distance correct – level incorrect -> check "**empty calibr.**" (005)



After 3 s, the following message appears



Note!

After the basic setup, an evaluation of the measurement with the aid of the envelope curve ("**display**" (09) function group) is recommended.

4 Function group "safety settings" (01)

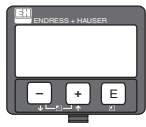

```
Group selection 013
alarm
alarm
alarm
temperature
linearisation
```

4.1 Function "output on alarm" (010)

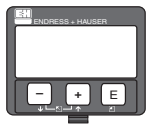

```
output on alarm 010
MIN (<=3.6mA)
✓MAX (22mA)
hold
```

This function is used to select the reaction of the device on an alarm.

Selection:

- MIN ($\leq 3.6\text{mA}$)
- MAX (22mA)
- hold
- user specific

MIN ($\leq 3.6\text{ mA}$)

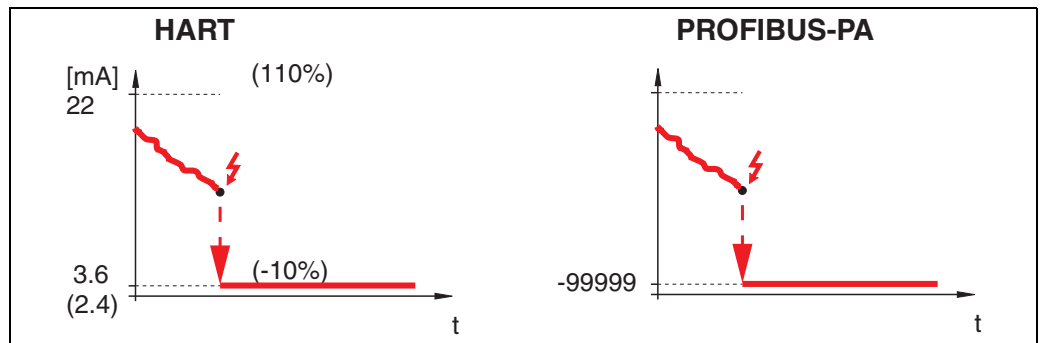

If the instrument is in alarm state, the output changes as follows:

- HART:MIN-Alarm 3.6 mA (2.4 mA for four-wire instruments)
- PROFIBUS-PA:MIN-Alarm -99999

MAX (22mA)

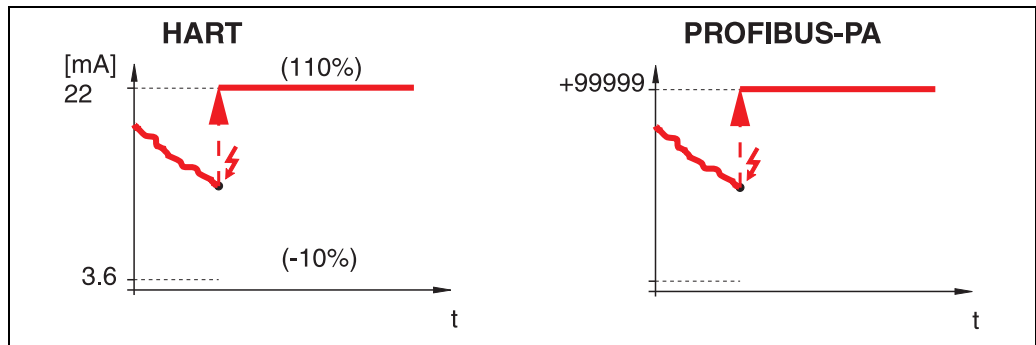

If the instrument is in alarm state, the output changes as follows:

- HART:MAX-Alarm 22 mA
- PROFIBUS-PA:MAX-Alarm +99999

hold

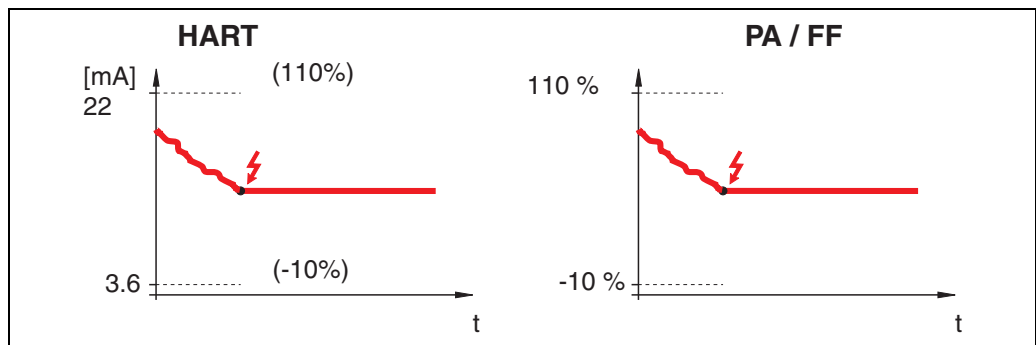

If the instrument is in alarm state, the last measured value is held.

user specific

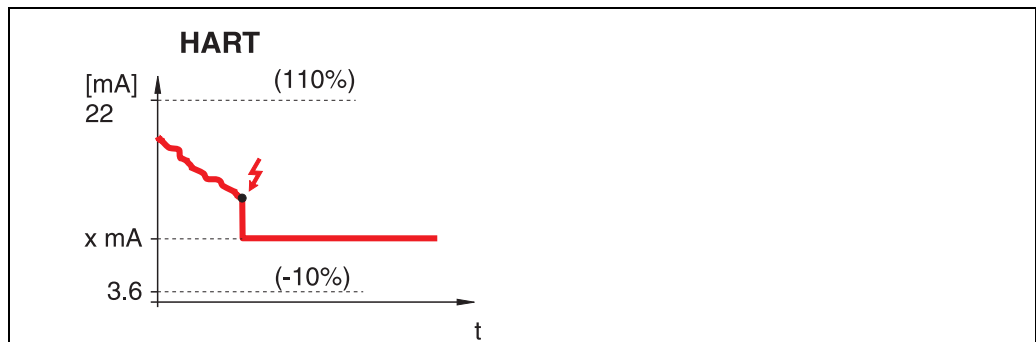

If the instrument is in an alarm state, the output is set to the value configured in "output on alarm" (011) (x mA).



Caution!
This selection is available for HART devices only!

4.2 Function "output on alarm" (011), HART only

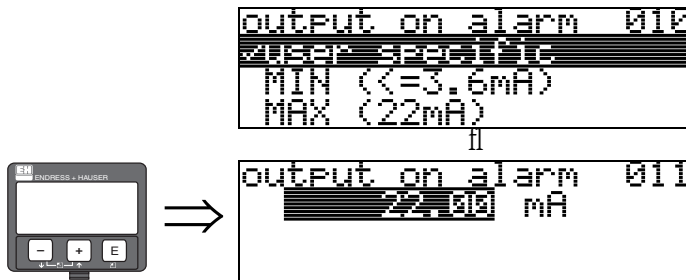

The current (in mA) which will be output in case of an alarm. This function is active when you selected **"user specific"** in the **"output on alarm" (010)** function.



Caution!
This function is available for HART devices only!

4.3 Function "outp. echo loss" (012)



Use this function to set the output response on echo loss.

Selection:

- alarm
- hold
- ramp %/min

alarm

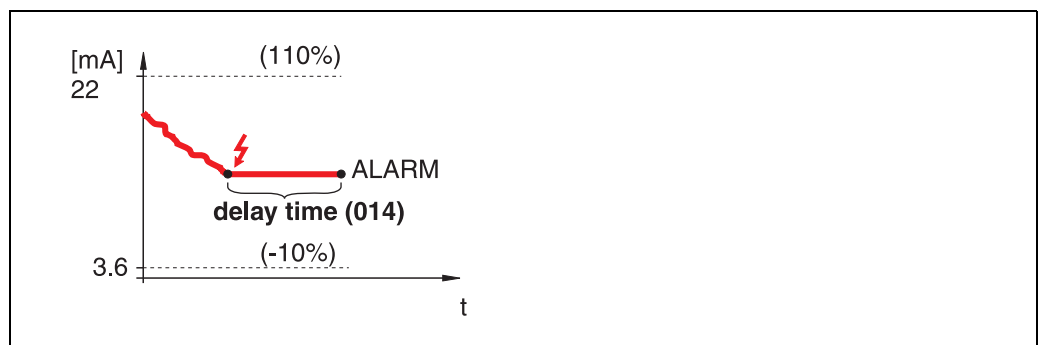

On echo loss, the instrument switches to alarm state after an adjustable **"delay time" (014)**. The output response depends on the configuration set in **"output on alarm" (010)**.

hold

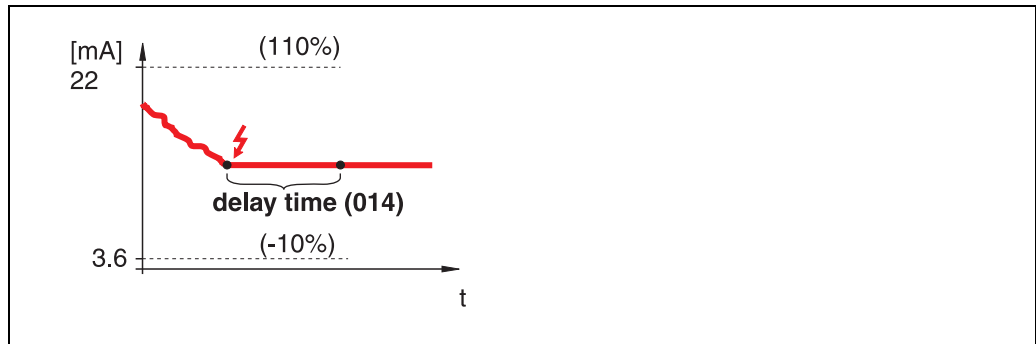

On echo loss, a warning is generated after a definable "delay time" (014). Output is held.

ramp %/min

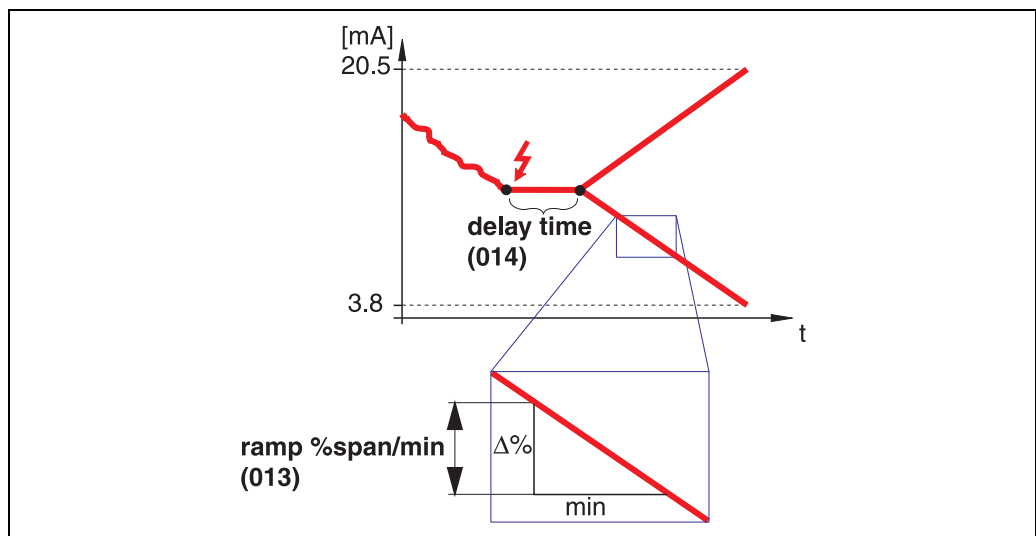

On echo loss, a warning is generated after a definable "delay time" (014). The output is changed towards 0% or 100% depending on the slope defined in "ramp %span/min" (013).

4.4 Function "ramp %span/min" (013)

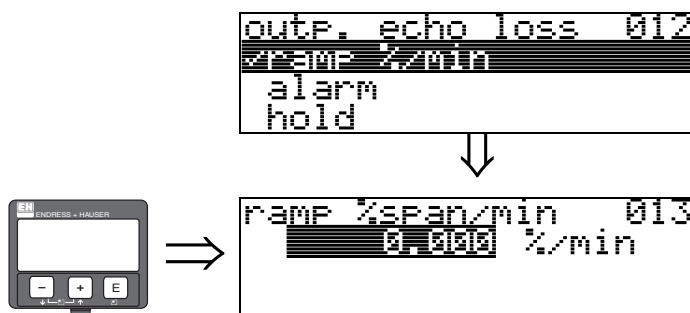

Ramp slope which defines the output value on echo loss. This value is used if "ramp %span/min" is selected in "outp. echo loss" (012). The slope is given in % of the measuring range per minute.

4.5 Function "delay time" (014)

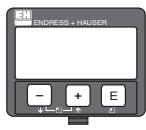

```

delay time          014
██████████ 60 s
in case of echo loss
max. 4000 sec.
  
```

Use this function to enter the delay time (Default = 60 s) after which a warning is generated on echo loss, or after which the instrument switches to alarm state.

4.6 Function "safety distance" (015)

A configurable safety distance is placed before the **"blocking dist." (059)** (→ 47). This distance warns you that any further level increase would make the measurement invalid, because the blocking distance would be compromised.

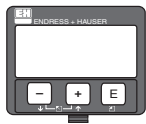
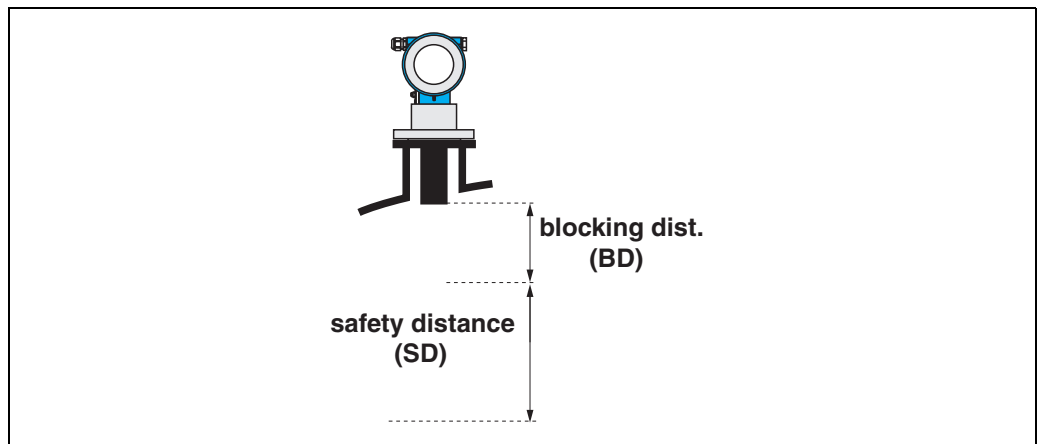

```

safety distance    015
██████████ 0.10 m
from blocking
distance
  
```

Enter the size of the safety distance here. The default value is: 0.1 m.

4.7 Function "in safety dist." (016)

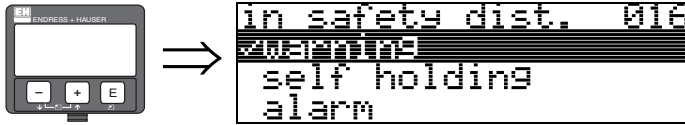

This function defines the response when the level enters the safety distance .

Selection:

- alarm
- **warning**
- self holding

alarm

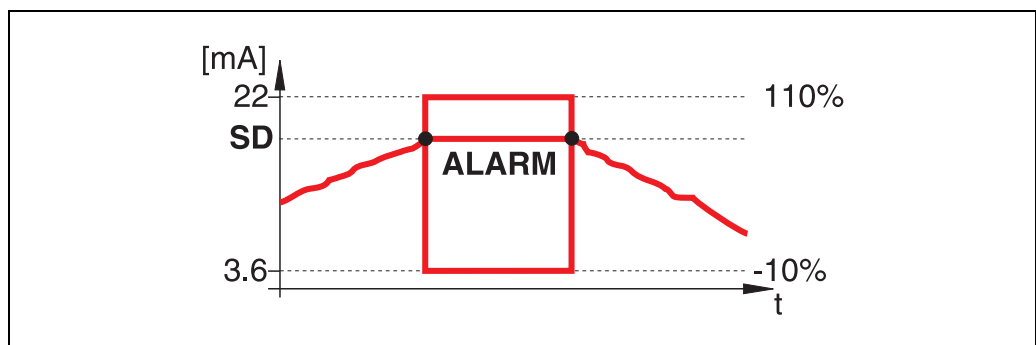

Instrument enters the defined alarm state ("output on alarm" (011)). The alarm message **E651 - "level in safety distance - risk of overspill"** is displayed.

If the level drops out of the safety distance, the alarm warning disappears and the instrument starts to measure again.

warning

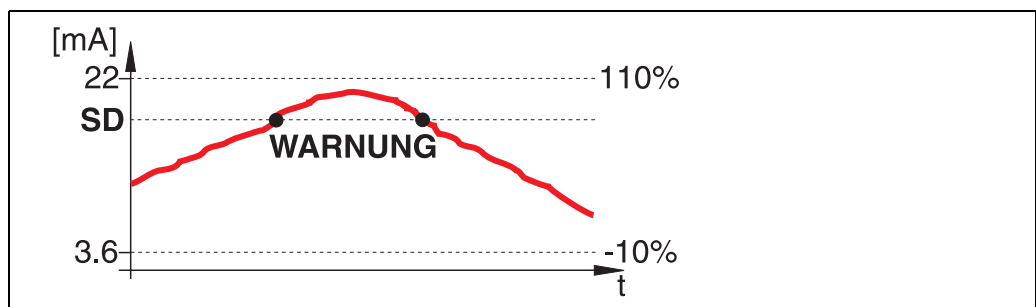

Instrument displays a warning **E651 - "level in safety distance - risk of overspill"**, but continues to measure. If the level leaves the safety distance, the warning disappears.

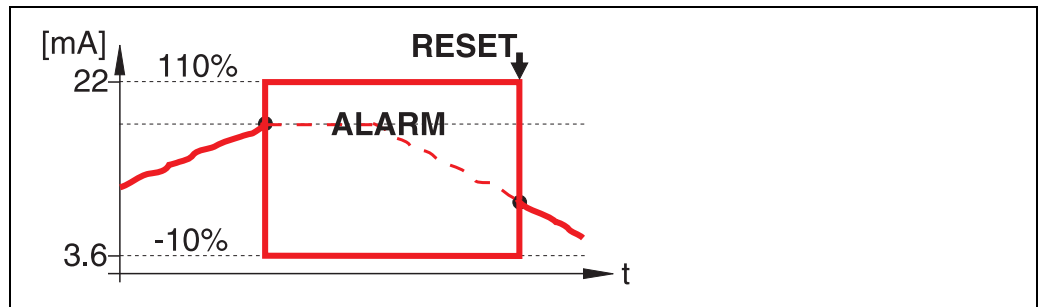
self holding

Instrument switches to defined alarm state ("output on alarm" (011)). The alarm message **E651** - "level in safety distance - risk of overspill" is displayed. If the level leaves the safety distance, the measurement continues only after a reset of the self holding (function: "ackn. alarm" (017)).

4.8 Function "ackn. alarm" (017)



This function acknowledges an alarm in case of "**self holding**".

Selection:

- no
- yes

no

The alarm is not acknowledged.

yes

Acknowledgement takes place.

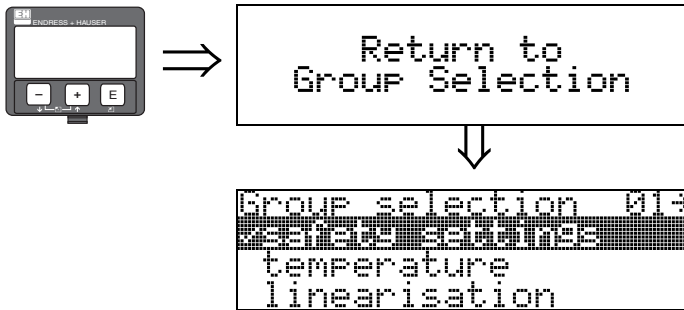

After 3 s, the following message appears

5 Function group "temperature" (03)

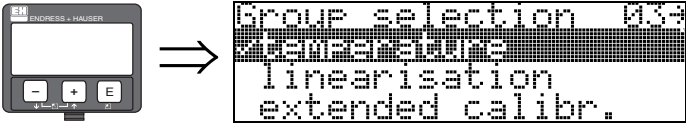

5.1 Function "measured temp." (030)

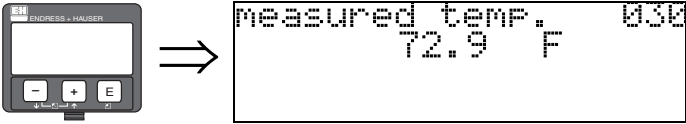

In this function the temperature at the sensor is displayed. The temperature unit is determined by the function "temperature unit" (0C6).

5.2 Function "max. temp. limit" (031)

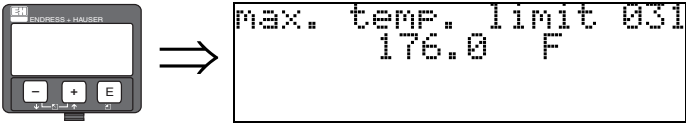

In this function the maximum permitted temperature of the sensor is displayed. The temperature unit is determined by the function "temperature unit" (0C6). If this temperature is exceeded, the sensor may become damaged.

5.3 Function "max. meas. temp." (032)



In this function the maximum temperature, which has ever been measured at the sensor, is displayed. The temperature unit is determined by the function "temperature unit" (0C6). This function is not influenced by a reset of the parameters.

5.4 Function "react high temp." (033)

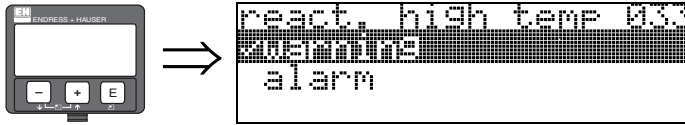

In this function you determine, how the Prosonic M will react if the maximum permitted temperature of the sensor is exceeded.

You may choose one of the following options:

Warning

The instrument continues measuring. An error message is displayed.

Alarm

The current output adopts the value defined in the function "**output on alarm**" (010). Additionally an error message is displayed.

5.5 Function "defect temp. sens." (034)



In this function you determine, how the Prosonic M will react, if the maximum permitted temperature of the sensor is exceeded.

You may choose one of the following options:

Alarm

The current output adopts the value defined in the function "**output on alarm**" (010). Additionally an error message is displayed.

Warning

The instrument continues measuring. An error message is displayed.

6 Function group "linearisation" (04)

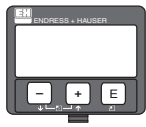

```

Group selection 04→
  /linearisation
  extended calibr.
  output
  
```

6.1 Function "level/ullage" (040)

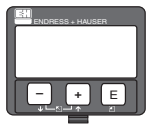

```

level/ullage 040
  /level CU
  level DU
  ullage CU
  ullage DU
  
```

Selection:

- level CU
- level DU
- ullage CU
- ullage DU

level CU

Level in customer units. The measured value can be linearised.
The "**linearisation**" (041) default value is set to a linear 0...100%.

level DU

Level in the selected "**distance unit**" (0C5).

ullage CU

Ullage in customer units. The value can be linearised.
The "**linearisation**" (041) default value is set to a linear 0...100%.

ullage DU

Ullage in the selected "**distance unit**" (0C5).



Note!

Reference point for the ullage is "full calibr." (=span).

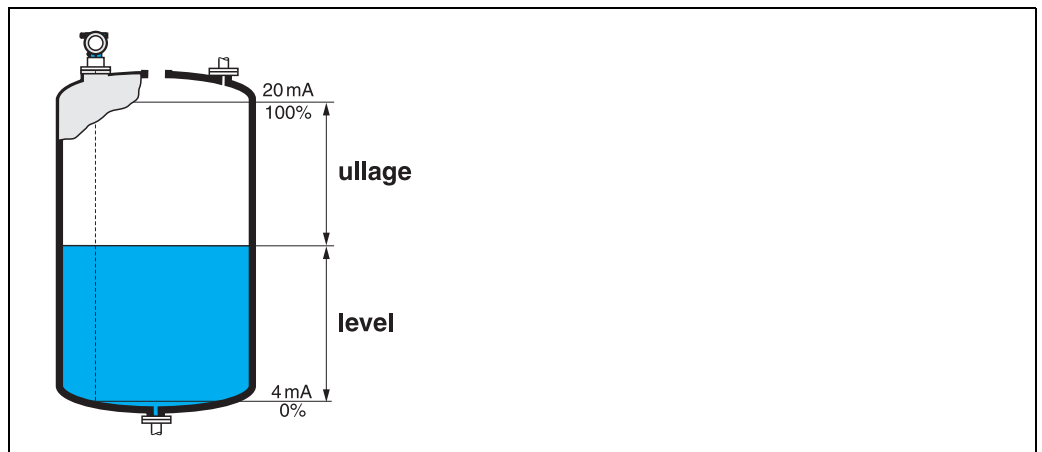

6.2 Function "linearisation" (041)

Linearisation defines the ratio of level to container volume or product weight and allows a measurement in customer units, e.g. metres, hectolitres etc. The measured value in (000) is then displayed in the selected unit.

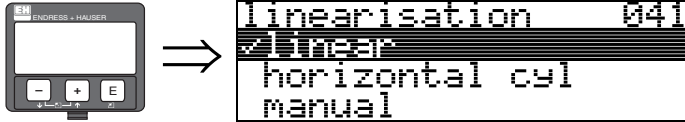

This function is used to select the linearisation modes.

Selection:

- linear
- horizontal cyl
- manual
- semi-automatic
- table on
- clear table

linear

The tank is linear e.g. a cylindrical vertical tank. You can measure in customer units by entering a maximum volume/weight.

You can select the "**customer unit**" (042). Define the volume value corresponding to the calibration in "**max. scale**" (046). This value corresponds to an output of 100% (= 20 mA for HART).

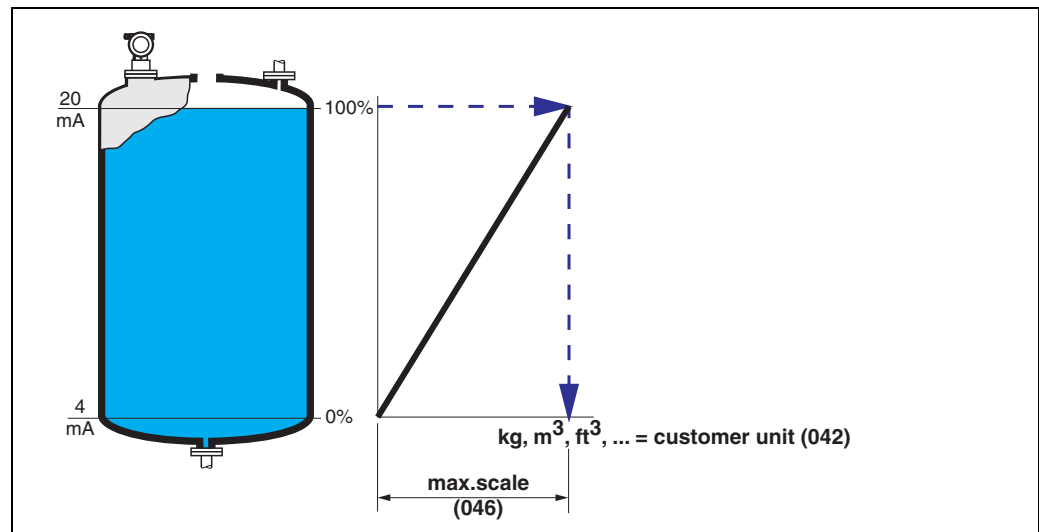

horizontal cyl

The volume, mass etc. are calculated automatically in cylindrical horizontal tanks by entering the "diameter vessel" (047), the "customer unit" (042) and the "max. scale" (046). The "max. scale" (046) corresponds to an output of 100% (= 20 mA for HART).

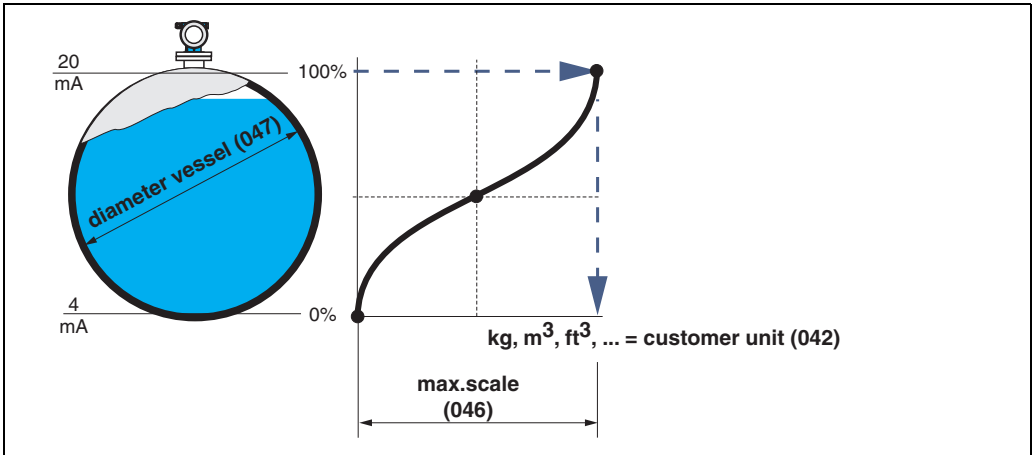

manual

If the level is not proportional to the volume or weight within the set measuring range, you can enter a linearisation table in order to measure in customer units. The requirements are as follows:

- The 32 (max.) value pairs for the linearisation curve points are known.
- The level values must be given in ascending order. The curve is monotonously increasing.
- The level heights for the first and last points on the linearisation curve correspond to empty and full calibration respectively.
- The linearisation takes place in the basic setup unit ("distance unit" (0C5)).

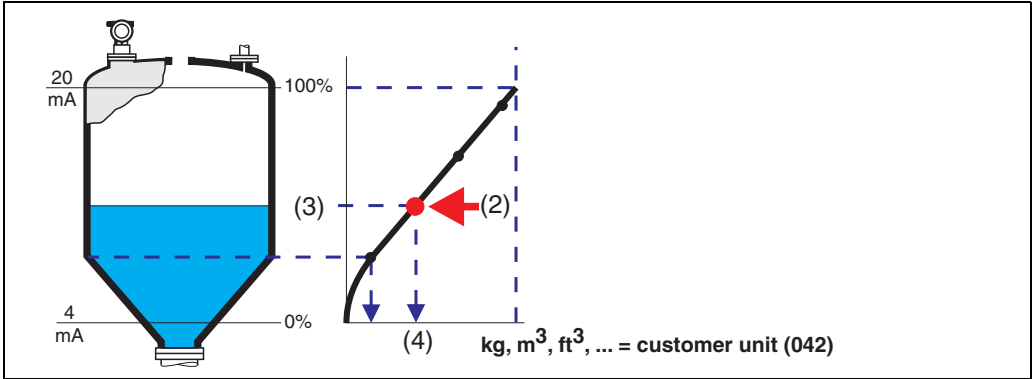

Each point (2) in the table is described by a value pair: level (3) and, for example, volume (4). The last value pair defines the 100% output (= 20 mA for HART).



Note!

The manual linearisation mode can also be used for flow measurements. To do this, simply enter the respective flow level (instead of the volume) into the table. You can find the appropriate flow values in the Q/h table of your channel or weir.

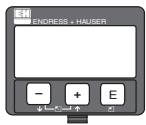

```

Linearisation 041
MANUAL
semi-automatic
table on
    
```

||

```

Linearisation 043
Tab.no. 1
Level 0.000m
Volume 0.000%
    
```

||

```

Linearisation 044
Tab.no. 1
Level 0.000m
Volume 0.000%
    
```

||

```

Linearisation 045
Tab.no. 1
Level 0.000m
Volume 0.000%
    
```

||

```

next point 045
YES
no
    
```

||

```

Linearisation 043
Tab.no. 2
Level 0.000m
Volume 0.000%
    
```

||

Continue until "next point" (045) is answered with no.

Select the table point (Point 1).

Enter the level belonging to Point 1.

Enter the corresponding volume.

Enter a further table point?

Next table point.



Note!

After making entries into the table, activate it with "table on".
The 100% value (=20 mA for HART) is defined by the last point in the table.



Note!

Before confirming 0.00 m as the level or 0.00% as the volume, activate the Edit mode with + or -.

Entries can be made into the linearisation table in FieldCare using the table editor.
You can also display the contents graphically.

semi-automatic

The tank is filled in stages when the linearisation curve is entered semi-automatically. The Prosonic M automatically detects the level and the corresponding volume/weight has to be entered. The procedure is similar to manual table entry, where the level value for each table point is given automatically by the instrument.



Note!

If the tank is emptied (out litres), pay attention to the following points:

- The number of points must be known in advance.
- The first table number = (32 - number of points).
- Entries in "**Tab. no.**" (**043**) are made in reverse order (last entry = 1).

table on

An entered linearisation table only becomes effective when activated.

clear table

Before making entries into the linearisation table, any existing tables must be deleted. The linearisation mode automatically switches to linear.



Note!

A linearisation table can be deactivated by selecting "**linear**" or "**horizontal cyl**" (or the "**level/ullage**" (**040**) function = "**level DU**", "**ullage DU**"). It is not deleted and can be reactivated at any time by selecting "**table on**".

6.3 Function "customer unit" (042)

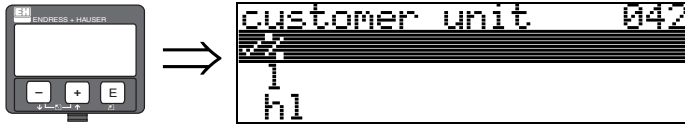

You can select the customer unit with this function.

Selection:

- %
- Volume: l, hl, m3, dm3, cm3, ft3, usgal, i gal
- Weight: kg, t, lb, ton
- Length: m, ft, mm, inch
- Flow: l/s, l/min, l/h, m3/s, m3/min, m3/h, ft3/s, gal/s, gal/m, gal/hr, mgal/d, igal/s, igal/min, igal/h

Dependence

The units of the following parameters are changed:

- measured value (000)
- input volume (045)
- max. scale (046)
- simulation value (066)

6.4 Function "table no." (043)

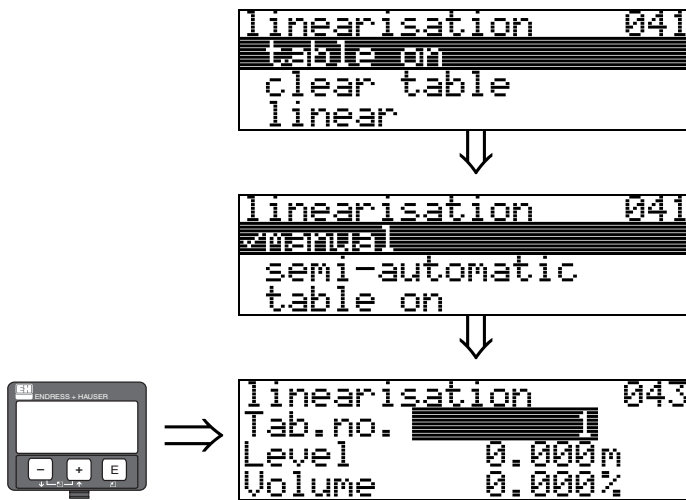

Position of the value pair in the linearisation table.

Dependence

Updates "input level" (044) , "input volume" (045).

6.5 Function "input level" (044)

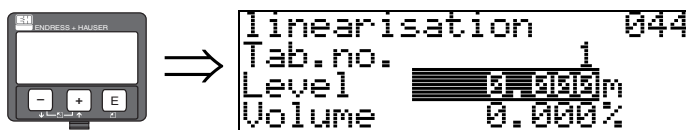

You can enter the level for each point of the linearisation curve with this function. When the linearisation curve is entered semi-automatically, Micropilot detects the level automatically.

User input:

Level in "distance unit" (0C5).

6.6 Function "input volume" (045)

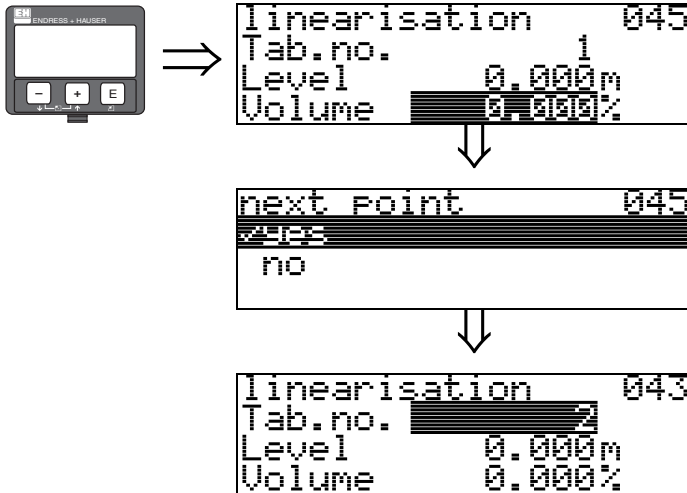

Specify the volume for each point of the linearisation curve with this function.

User input:

Volume in "customer unit" (042).

6.7 Function "max. scale" (046)



You can enter the end value of the measuring range with this function. This input is necessary if you selected "linear" or "horizontal cyl" in the "linearisation" (041) function.

6.8 Function "diameter vessel" (047)

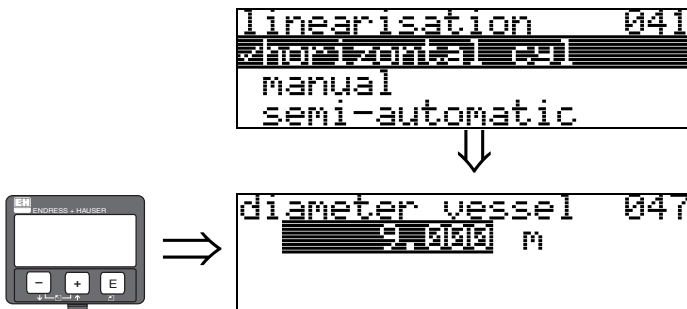

Enter the tank diameter with this function. This entry is necessary if you selected "horizontal cyl" in the "linearisation" (041) function.

7 Function group "extended calibr." (05)

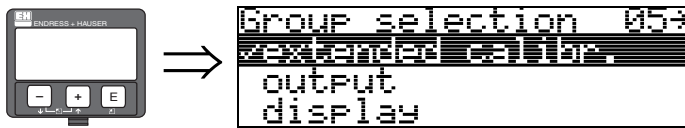

7.1 Function "selection" (050)

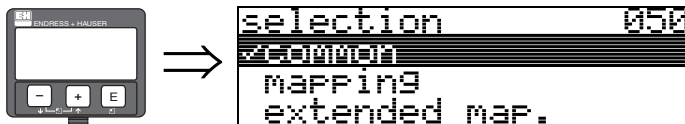

Select the function of the extended calibration.

Selection:

- **common**
leads to the functions "echo quality" (056), "offset" (057), "output damping" (058) and "blocking distance" (059)
- **mapping**
leads to the functions for an interference echo suppression (tank map): (051) ... (053)
- **extended map**
leads to the functions "pres. map. dist." (054) and "cust. tank map" (055)

7.2 Function "check distance" (051)



This function triggers the mapping of interference echoes. To do so, the measured distance must be compared with the actual distance to the product surface. The following options are available for selection:

Selection:

- distance = ok
- dist. too small
- dist. too big
- **dist. unknown**
- manual

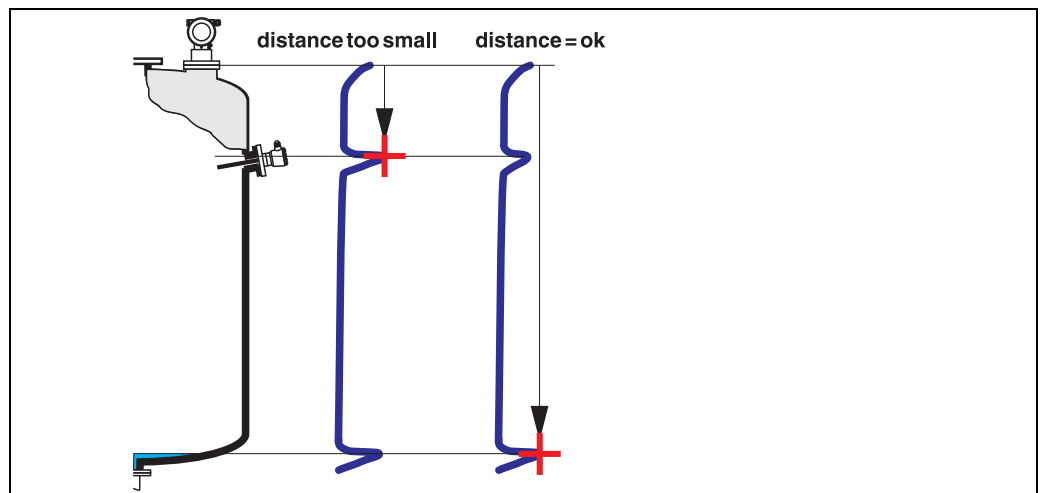

distance = ok

- mapping is carried out up to the currently measured echo
 - The range to be suppressed is suggested in the "**range of mapping (052)**" function
- Anyway, it is wise to carry out a mapping even in this case.

dist. too small

- At the moment, an interference is being evaluated
- Therefore, a mapping is carried out including the presently measured echoes
- The range to be suppressed is suggested in the "**range of mapping (052)**" function

dist. too big

- This error cannot be remedied by interference echo mapping
- Check the application parameters (002), (003), (004) and "**empty calibr.**" (005)

dist. unknown

If the actual distance is not known, no mapping can be carried out.

manual

A mapping is also possible by manual entry of the range to be suppressed. This entry is made in the "**range of mapping (052)**" function.



Caution!

The range of mapping must end 0.5 m (1.6 ft) before the echo of the actual level. For an empty tank, do not enter E, but E - 0.5 m (1.6 ft).

7.3 Function "range of mapping" (052)

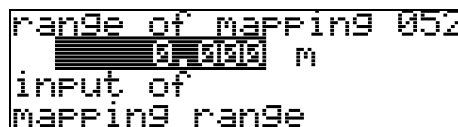
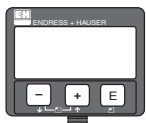

This function displays the suggested range of mapping. The reference point is always the sensor membrane. This value can be edited by the operator. For manual mapping, the default value is: 0 m.

7.4 Function "start mapping" (053)

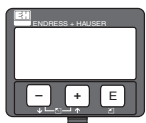

This function is used to start the interference echo mapping up to the distance given in "**range of mapping**" (052).

Selection:

- **off:** no mapping is carried out
- **on:** mapping is started



Caution!

If a mapping already exists, it is overwritten up to the distance specified in "**range of mapping**" (052). Beyond this value the existing mapping remains unchanged.

7.5 Function "pres. map dist." (054)

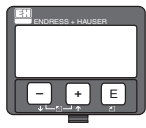

```
Pres. map dist. 054  
0.000 m
```

Displays the distance up to which a mapping has been recorded.
A value of 0 indicates that no mapping was recorded so far.

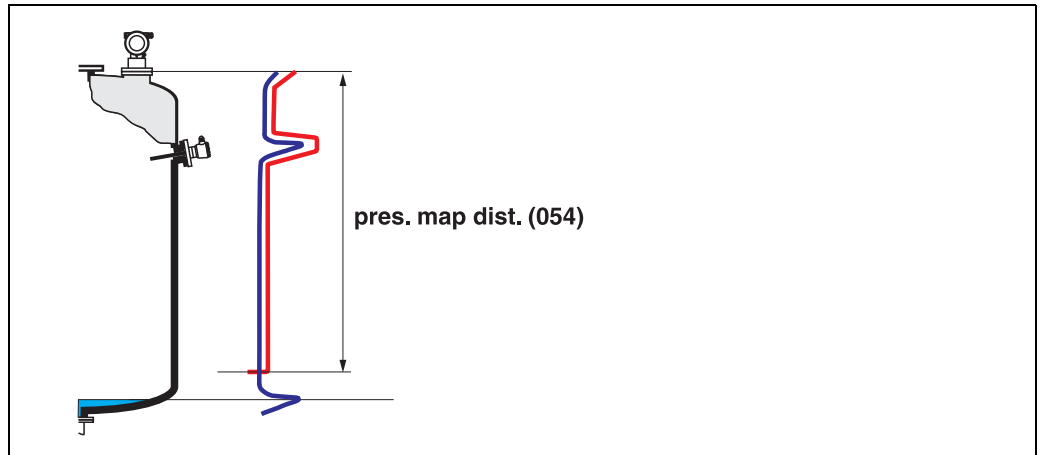

7.6 Function "cust. tank map" (055)



This function displays the evaluation mode using the customer tank map.

Selection:

- inactive
- active
- reset

inactive

No tank mapping has been recorded, or map is switched off. Evaluation is only using FAC (→ 83).

active

Evaluation is using the customer tank map (→ 82).

reset

Deletes the complete tank map.

7.7 Function "echo quality" (056)

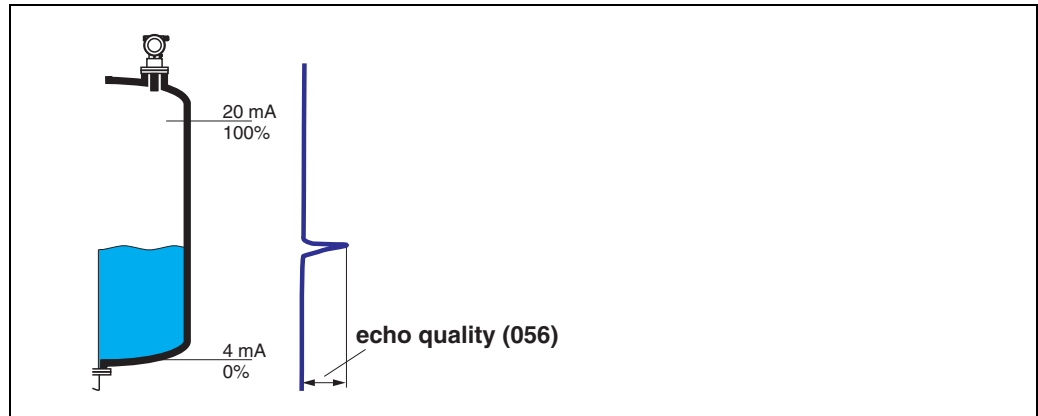
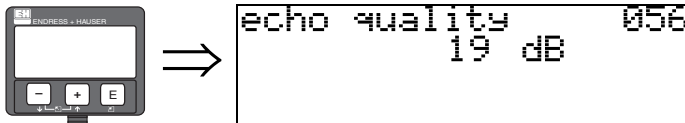

The echo quality is the benchmark for measurement reliability. It describes the amount of reflected energy and depends primarily on the following conditions:

- Surface characteristics (waves, foam etc.)
- Distance between sensor and product

Low values increase the probability that the echo is lost through a change in measurement conditions, e.g. turbulent surface, foam, large measuring distance.

7.8 Function "offset" (057)

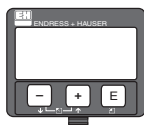

```
offset 057
0.000 m
will be added to the
measured level
```

This function corrects the measured level by a constant value. The entered value is added to the measured level.

7.9 Function "output damping" (058)

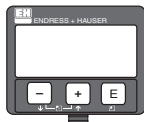

```
output damping 058
5.0 s
```

Influences the time an output requires to react to a sudden level jump (63% of steady state). A high value attenuates, for example, the influences of rapid changes on the measured variable.

User input:

0...255 s

The default value depends on the selected application parameters "**tank shape**" (002), "**medium property**" (003) and "**process cond.**" (004).

7.10 Function "blocking dist." (059)

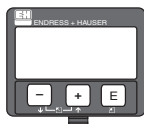

```
blocking dist. 059
0.200 m
BD=blocking dist.
```

In this function the blocking distance is displayed. Level echoes within the blocking distance can not be detected by the Prosonic M. Make sure that the maximum level will never run into the blocking distance.

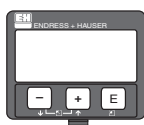

```
Return to
Group Selection
```



```
Group selection 059
extended calibr.
output
display
```

After 3 s, the following message appears

8 Function group "output" (06), - "profibus param." (06), PROFIBUS-PA only

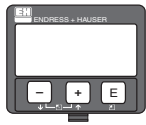

```
Group selection 06→
output
display
diagnostics
```

Display at HART and FOUNDATION Fieldbus instrument

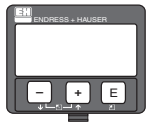

```
Group selection 06→
Profibus param.
display
diagnostics
```

Display at PROFIBUS-PA instrument

8.1 Function "commun. address" (060), HART only

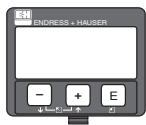

```
commun. address 060

```

Enter the communication address for the instrument with this function.

- Standard: 0
- Multidrop: 1-15

The output current is constant at 4mA in multidrop mode.



Caution!

This function is available for HART devices only!

8.2 Function "instrument addr." (060), PROFIBUS-PA only

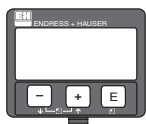

```
instrument addr. 060
16
```

The PA bus address is displayed in this field. The address is set either directly on the instrument using DIP switches (see instrument operating instructions) or using a special SetSlaveAddress command via the bus, e.g. by the FieldCare.



Caution!

This function is available for PROFIBUS-PA devices only!

8.3 Function "no. of preambels" (061), HART only



Enter the number of preambels for the HART protocol with this function.
An increase in the value is advisable for "bad" lines with communications problems.



Caution!
This user input is available for HART devices only!

8.4 Function "ident number" (061), PROFIBUS-PA only



- **manufacturer**
- **profile**

manufacturer

Set to 152C hex according to manufacturer (PNO registered).

profile

Setting defined as in PA Profile 3.0: 9700 hex - instrument with one AI block.



Caution!
This function is available for PROFIBUS-PA devices only!

8.5 Function "thres. main val." (062), HART only



The output of negative level values can be suppressed with this function.

Selection:

- **off**: minimum output -10% (3.8 mA for HART)
- **on**: minimum output 0% (4 mA for HART)

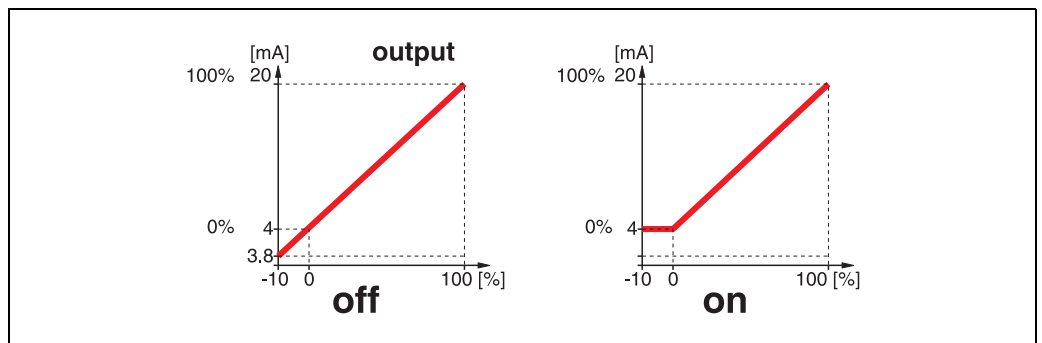

Caution!

This user input is available for HART devices only!

8.6 Function "set unit to bus" (062), PROFIBUS-PA only



- **confirm**

After confirming this function, the unit of the measured variable is taken over in the AI block (PV scale -> Out scale).

This function must always be executed after changing the unit.



Caution!

This function is available for PROFIBUS-PA devices only!

8.7 Function "curr. output mode" (063), HART only

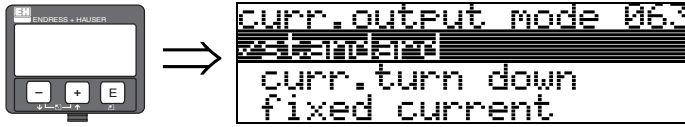

In this function you specify the mode of the current output.
You may choose one of the following options:

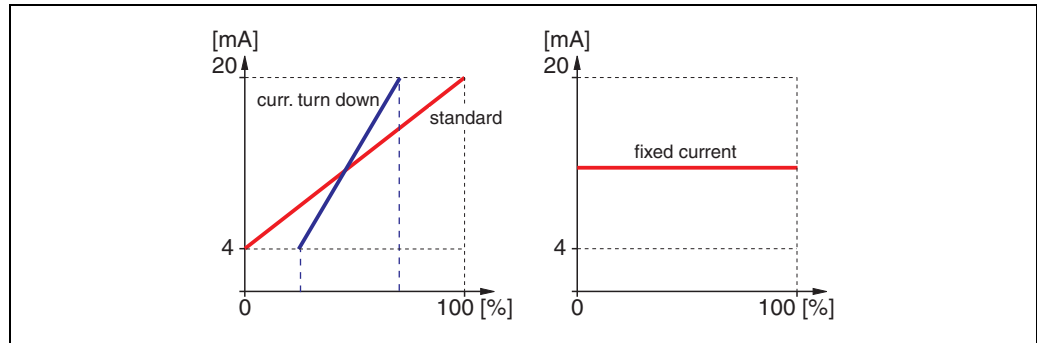

standard

The total measuring range (0 ... 100%) will be mapped to the current interval (4 ... 20 mA).

curr. turn down

Only a part of the measuring range will be mapped to the current interval (4 ... 20 mA).

Use the functions "**4-mA-value**" (068) and "**20-mA-value**" (069) to define the concerning range.

fixed current

The current is fixed. The measured value is transmitted by the HART signal only. The value of the current is defined in the "**fixed current**" (064) function.



Caution!
This function is active for HART devices only.

8.8 Function "out value" (063), PROFIBUS-PA only

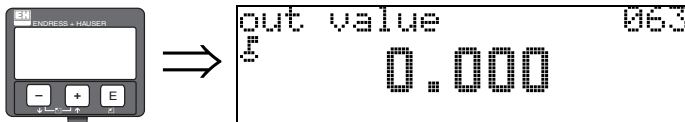

This displays the AI block output.



Caution!
This function is available for PROFIBUS-PA devices only!

8.9 Function "fixed cur. value" (064), HART only



Set the fixed current value with this function. This entry is necessary when you have switched on the "**fixed current**" (063) function.

User input:
3,8...20,5 mA



Caution!
This user input is available for HART devices only!

8.10 Function "out status" (064), PROFIBUS-PA only

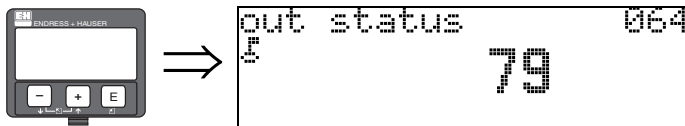

Displays the current output status (for value, see operating instructions of relevant instrument).



Caution!
This function is available for PROFIBUS-PA devices only!

8.11 Function "simulation" (065)

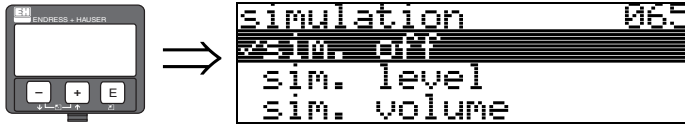

If necessary, linearisation, the output signal and the current output can be tested with the simulation function. You have the following simulation options:

Selection:

- **sim. off**
- sim. level
- sim. volume
- sim. current (HART only)

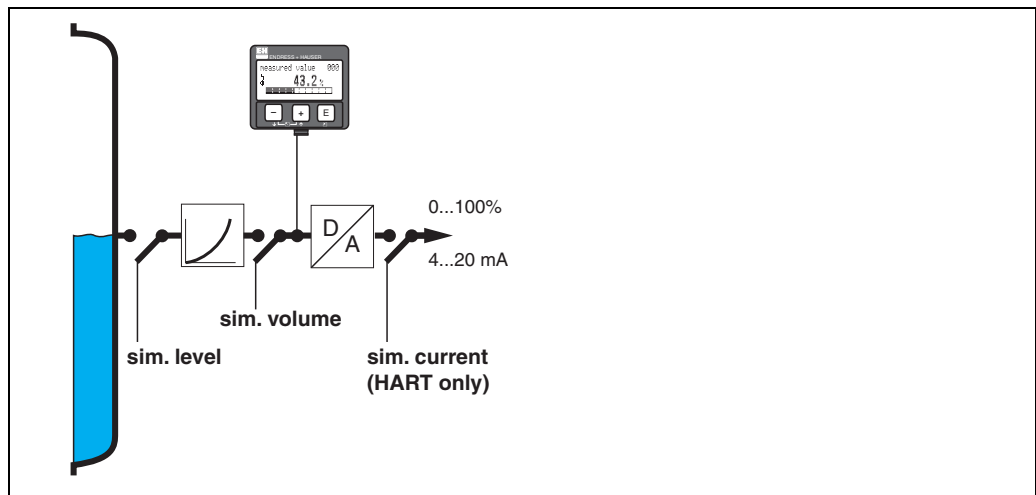

sim. off

Simulation is switched off.

sim. level

Enter the level value in "**simulation value**" (066).

The functions

- measured value (000)
- measured level (0A6)
- output current" (067) - only with HART instruments!
follow the entered values.

sim. volume

Enter the volume value in "**simulation value**" (066).

The functions

- measured value (000)
- output current" (067) - only with HART instruments!
follow the entered values.

sim. current (HART only)

Enter the current value in "**simulation value**" (066).

The function

- output current" (067) - only with HART instruments!
follows the entered values.

8.12 Function "simulation value" (066)

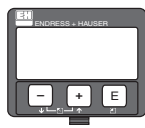

simulation value 066
2.54 m

After selecting the "**sim. level**" option in the "**simulation**" (065) function, the following message appears in the display: you can enter the level.

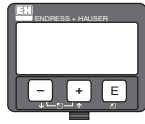

simulation value 066
28.16 %

After selecting the "**sim. volume**" option in the "**simulation**" (065) function, the following message appears in the display: you can enter the volume.

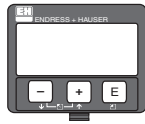

simulation value 066
8.00 mA

After selecting the "**sim. current**" option in the "**simulation**" (065) function, the following message appears in the display: Enter the output current (only for HART instruments).

8.13 Function "output current" (067), HART only

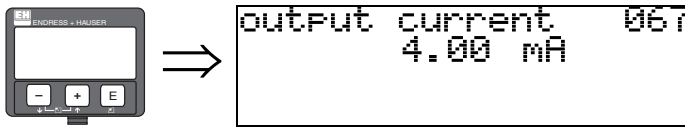

Displays the output current in mA.



Caution!
This function is available for HART devices only!

8.14 Function "2nd cyclic value" (067), PROFIBUS-PA only



Selects the second cyclical value.

- height/dist.
- temperature

The Prosonic M always transmits the distance as the second cyclical value.



Caution!
This function is available for PROFIBUS-PA devices only!

8.15 Function "4mA-value" (068), HART only



In this function specify the level (or volume, weight, flow resp.), at which the output current should be 4 mA. This value will be used if you choose the option "curr. turn down" in the "**current output mode**" (063) function.

8.16 Function "select v0h0" (068), PROFIBUS-PA only

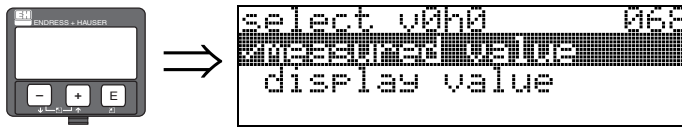

Selects the value displayed in "**measured value**" (000).

Selection:

- **measured value**
- display value

measured value

The configured measured value is displayed in the "**measured value**" (000) function.

display value

The value in "**display value**" (069) is displayed in the "**measured value**" (000) function.



Caution!

This function is available for PROFIBUS-PA devices only!

8.17 Function "20mA-value" (069), HART only



In this function specify the level (or volume, weight, flow resp.), at which the output current should be 20 mA. This value will be used if you choose the option "curr. turn down" in the "**current output mode**" (063) function.

8.18 Function "display value" (069), PROFIBUS-PA only

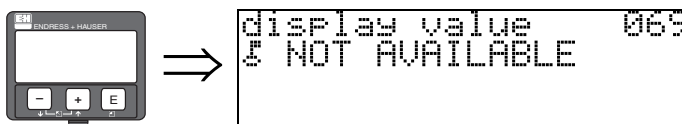

This field can be set externally, e.g. from a PLC. The value is then displayed as the main measured variable in the display by selecting the "**select v0h0**" (068) = "**display value**" function.



Caution!

This function is available for PROFIBUS-PA devices only!

9 Function group "Envelope curve" (0E)

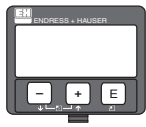

```
Group selection 0E
Envelope curve
display
diagnostics
```

9.1 Function "plot settings" (0E1)

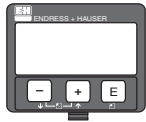

```
Plot settings 0E1
Envelope curve
env.curve+FAC
env.curve+cust.map
```

Here select which information is displayed in the LCD:

- **envelope curve**
- env.curve+FAC (on FAC see → 83)
- env.curve+cust.map (i.e. customer tank map is also displayed, see → 82)

9.2 Function "recording curve" (0E2)

This function defines whether the envelope curve is read as a

- **single curve**
- or
- **cyclic.**

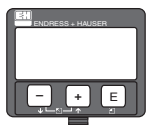

```
Recording curve 0E2
Single curve
cyclic
```



Note!

If the cyclical envelope curve is active in the display, the measured variable is refreshed in a slower cycle time. It is therefore recommended to exit the envelope curve display after optimising the measuring point.

9.3 Function "envelope curve display" (OE3)

The envelope curve is displayed in this function. You can use it to obtain the following information:

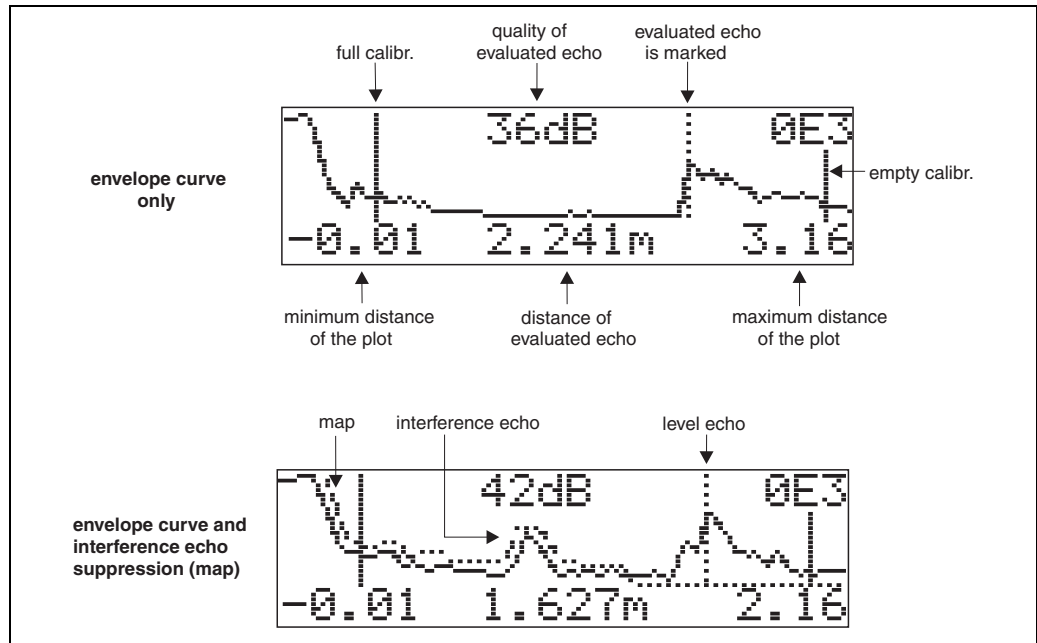

Navigating in the envelope curve display

Using navigation, the envelope curve can be scaled horizontally and vertically and shifted to the left or the right. The active navigation mode is indicated by a symbol in the top left hand corner of the display.

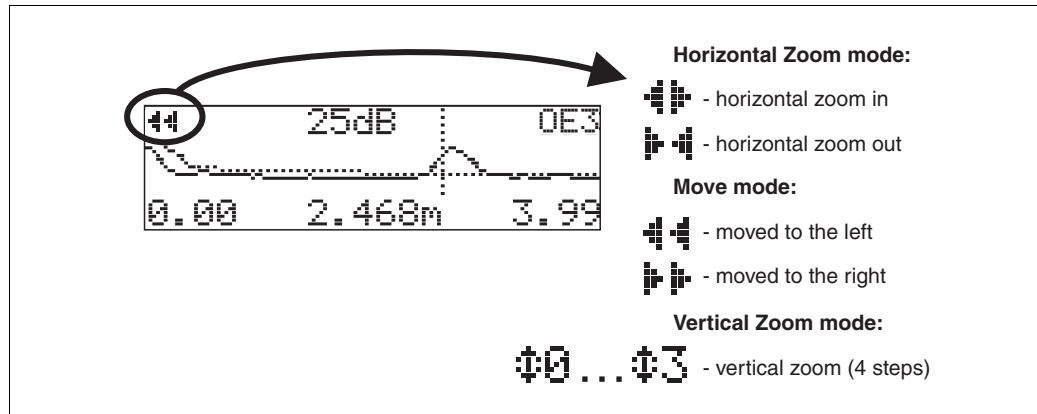

Horizontal Zoom mode

Firstly, go into the envelope curve display. Then press $\boxed{+}$ or $\boxed{-}$ to switch to the envelope curve navigation. You are then in Horizontal Zoom mode. Either $\leftarrow \rightarrow$ or $\rightarrow \leftarrow$ is displayed.

You now have the following options:

- $\boxed{+}$ increases the horizontal scale.
- $\boxed{-}$ reduces the horizontal scale.

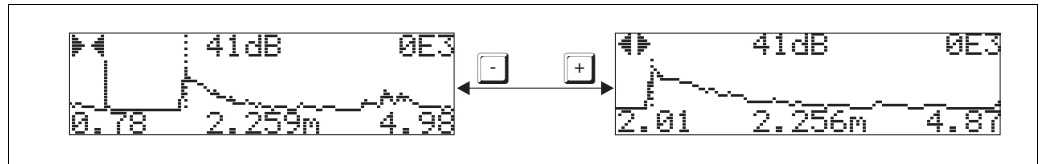
**Move mode**

Then press \boxed{E} to switch to Move mode. Either $\leftarrow \rightarrow$ or $\rightarrow \leftarrow$ is displayed.

You now have the following options:

- $\boxed{+}$ shifts the curve to the right.
- $\boxed{-}$ shifts the curve to the left.

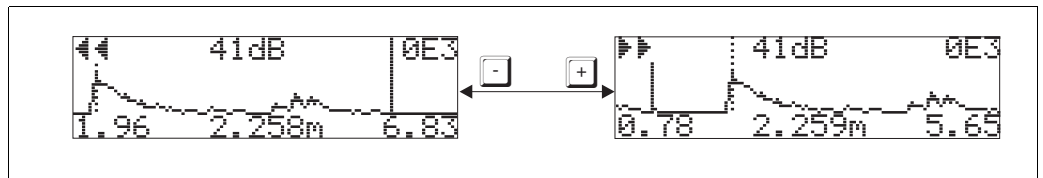
**Vertical Zoom mode**

Press \boxed{E} once more to switch to Vertical Zoom mode. $\text{Z}1$ is displayed.

You now have the following options:

- $\boxed{+}$ increases the vertical scale.
- $\boxed{-}$ reduces the vertical scale.

The display icon shows the current zoom factor ($\text{Z}0$ to $\text{Z}3$).

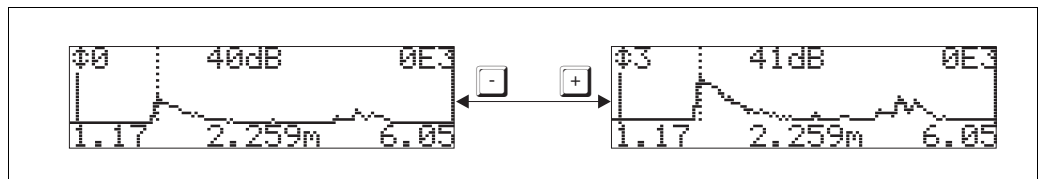
**Exiting the navigation**

- Press \boxed{E} again to run through the different modes of the envelope curve navigation.
- Press $\boxed{+}$ and $\boxed{-}$ to exit the navigation. The set increases and shifts are retained. Only when you reactivate the "recording curve" (OE2) function does the Prosonic use the standard display again.

10 Function group "display" (09)

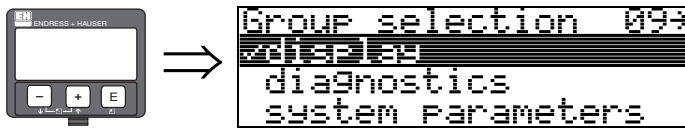

10.1 Function "language" (092)



Selects the display language.

Selection:

- English
- Deutsch
- Français
- Español
- Italiano
- Nederlands
- Japanese

Dependence

All texts are changed.

10.2 Function "back to home" (093)



If no entry is made using the display during the specified time period, the display returns to the measured value display.

9999 s means that there is no return.

User input:

3...9999 s

10.3 Function "format display" (094)



Selects the display format.

Selection:

- decimal
- 1/16"

decimal

The measured value is given in decimal form in the display (e.g. 10.70%).

1/16"

The measured value is given in the display in this format (e.g. 5'05-14/16").

This option is only possible for "**distance unit**" (0C5) - "ft" and "in"!

10.4 Function "no.of decimals" (095)

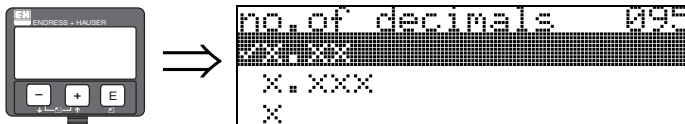

Selection:

- X
- X.X
- X.XX
- X.XXX

10.5 Function "sep. character" (096)



Selection:

- .
- ,

.

The decimal place is separated by a point.

,

The decimal place is separated by a comma.

10.6 Function "display test" (097)



All display pixels are switched on. If the whole LCD is dark, it is working correctly.

11 Function group "diagnostics" (0A)

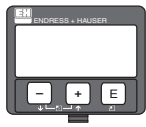

```

Group selection 0A?
diagnostics
system parameters
service
  
```

In the "**diagnostics**" function group, you can display and confirm error messages.

Type of error

Errors that occur during commissioning or measuring are displayed immediately on the local display. If two or more system or process errors occur, the error with the highest priority is the one shown on the display.

The measuring system distinguishes between two types of error:

- **A (Alarm):**

Instrument goes into a defined state (e.g. MAX)

Indicated by a constant  symbol.

(For a description of the codes, →  86)

- **W (Warning):**

Instrument continue measuring, error message is displayed.

Indicated by a flashing  symbol.

(For a description of the codes, →  86)

- **E (Alarm / Warning):**

Configurable (e.g. loss of echo, level within the safety distance)

Indicated by a constant/flashing  symbol.

(For a description of the codes, →  86)

11.1 Function "present error" (0A0)



The present error is shown using this function.

11.2 Function "previous error" (0A1)



The last error presented is shown with this function.

11.3 Function "clear last error" (0A2)

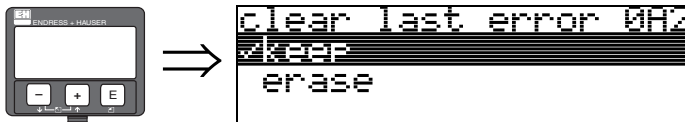

Selection:

- keep
- erase



Caution!

This function can be performed on the display only!

11.4 Function "reset" (0A3)



Caution!

A reset sets the instrument back to the factory settings. This can lead to an impairment of the measurement. Generally, you should perform a basic setup again following a reset.

A reset is only necessary:

- if the instrument no longer functions
- if the instrument must be moved from one measuring point to another
- if the instrument is being de-installed /put into storage/installed



```
reset                                0A3
██████████
for reset code
see manual
```

Entry ("reset" (0A3)):

- 333 = customer parameters (HART)
- 33333 = customer parameters (PROFIBUS-PA and FOUNDATION Fieldbus)

333 = reset customer parameters for HART

33333 = reset customer parameters for PROFIBUS-PA and FOUNDATION Fieldbus

This reset is recommended whenever an instrument with an unknown 'history' is to be used in an application:

- The Micropilot is reset to the default values.
- The customer specific tank map is not deleted.
- A linearisation is switched to "**linear**" although the table values are retained. The table can be reactivated in the "**linearisation**" (04) function group.



Note!

5-point linearity protocol

The specified measuring accuracy is a typical value. With the production of the 5-point linearity protocol the measuring system (sensor and electronic) is adjusted exactly to one another and the measuring accuracy is optimized for the specified range. To realize this, the parameter "zero distance" is fine adjusted. After a reset the value for the zero distance has to be re-parameterized in the service menu according to the data on the associated 5-point linearity protocol. Please contact the Endress+Hauser service.

List of functions that are affected by a reset:

- | | |
|-------------------------|--------------------------|
| ■ tank shape (002) | ■ customer unit (042) |
| ■ empty calibr. (005) | ■ diameter vessel (047) |
| ■ full calibr. (006) | ■ range of mapping (052) |
| ■ output on alarm (010) | ■ pres. Map dist (054) |
| ■ output on alarm (011) | ■ offset (057) |
| ■ outp. echo loss (012) | ■ low output limit (062) |
| ■ ramp %span/min (013) | ■ fixed current (063) |
| ■ delay time (014) | ■ fixed cur. value (064) |
| ■ safety distance (015) | ■ simulation (065) |
| ■ in safety dist. (016) | ■ simulation value (066) |
| ■ level/ullage (040) | ■ format display (094) |
| ■ linearisation (041) | ■ distance unit (0C5) |
| | ■ download mode (0C8) |

The tank map can also be reset in the "**cust. tank map**" (055) function of the "**extended calibr.**" (05) function group.

This reset is recommended whenever an instrument with an unknown 'history' is to be used in an application or if a faulty mapping was started:

- The tank map is deleted. The mapping must be recommenced.

11.5 Function "unlock parameter" (0A4)

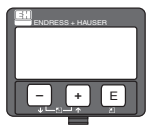

```
unlock parameter 0A4
⌘ Hardware locked
```

Set-up can be locked and unlocked with this function.

11.5.1 Locking of the configuration mode

The Micropilot can be protected in two ways against unauthorised changing of instrument data, numerical values or factory settings:

"unlock parameter" (0A4):

A value $\langle \rangle$ 100 for HART (e.g. 99) or $\langle \rangle$ 2457 for PROFIBUS-PA and FOUNDATION Fieldbus (e.g. 2456) must be entered in "unlock parameter" (0A4) in the "diagnostics" (0A) function group. The lock is shown on the display by the ⌘ symbol and can be released again either via the display or by communication.

Hardware lock:

The instrument is locked by pressing the + and - and E keys at the same time.

The lock is shown on the display by the ⌘ symbol and can **only** be unlocked again via the display by pressing the + and - and E keys at the same time again. It is **not** possible to unlock the hardware by communication.

All parameters can be displayed even if the instrument is locked.

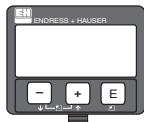

```
measured value 000
63.460 %
████████████████████
```



```
unlock parameter 0A4
⌘ Hardware locked
```



```
measured value 000
⌘ 63.480 %
████████████████████
```

+ and - and E press simultaneous

The LOCK_SYMBOL appears on the LCD.

11.5.2 Unlocking of configuration mode

If an attempt is made to change parameters when the instrument is locked, the user is automatically requested to unlock the instrument:

"unlock parameter" (0A4):

By entering the unlock parameter (on the display or via communication)

100 = for HART devices

2457 = for PROFIBUS-PA and FOUNDATION Fieldbus devices

the Micropilot is released for operation.

Hardware-Verriegelung:

After pressing the **+** and **-** and **E** keys at the same time, the user is asked to enter the unlock parameter

100 = for HART devices

2457 = for PROFIBUS-PA and FOUNDATION Fieldbus devices.

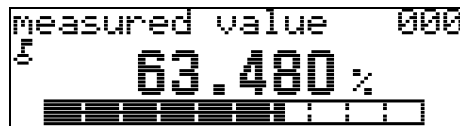

||



||

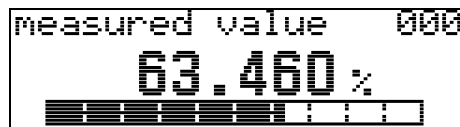

+ and **-** and **E** press simultaneous

Please enter unlock code and confirm with **E**.



Caution!

Changing certain parameters such as all sensor characteristics, for example, influences numerous functions of the entire measuring system, particularly measuring accuracy. There is no need to change these parameters under normal circumstances and consequently, they are protected by a special code known only to the Endress+Hauser service organization. Please contact Endress+Hauser if you have any questions.

11.6 Function "measured dist." (0A5)

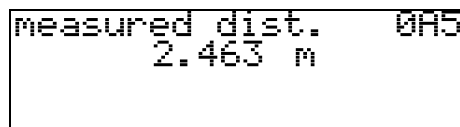
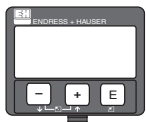

Display of measured distance in the selected "distance unit" (0C5).

11.7 Function "measured level" (0A6)

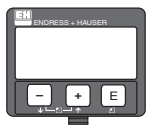

```
measured level 0A6
2.541 m
```

Display of measured level in the selected "distance unit" (0C5).

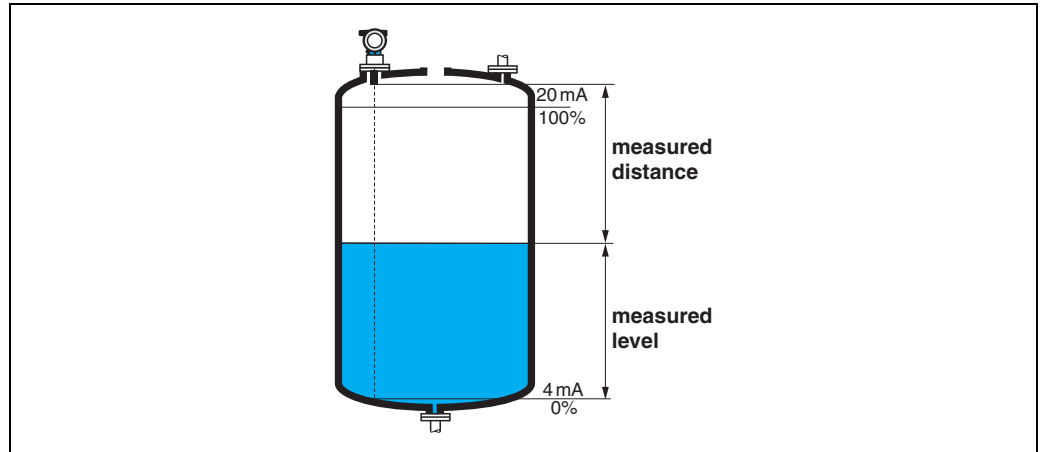

11.8 Function "detection window" (0A7) (from Software 01.04.00)



```
detection window 0A7
voff
on
reset
```

Is used to switch the detection window on and off and to reset an existing detection window. If this function is switched on, a window is defined surrounding the current level echo (typical width: 1 to 2.5 m; depending on the application parameters). The window always moves together with a rising a falling echo. Echos beyond the limits of the window are ignored for a certain time.

Selection:

- off
- on
- reset

After selection of this option, the current window is reset, the level echo is looked for in the complete measuring range and a new window is defined surrounding the current level echo.

11.9 Function "application par." (0A8)

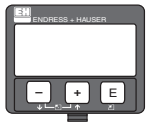

```

Application par. 0A8
✓not modified
modified
    
```

Displays whether or not one of the settings dependent on the **"tank shape" (002)**, **"medium property" (003)** and **"process cond." (004)** application parameters has been changed or not.

If, for example, the **"output damping" (058)** is changed, the **"application par."** shows **"modified"**.

Display:

- not modified
- modified

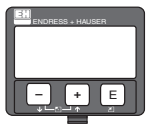

```

Return to
Group Selection
    
```



```

Group selection 0A8
diagnostics
system parameters
service
    
```

After 3 s, the following message appears

12 Function group "system parameters" (0C)

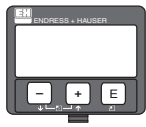

```
Group selection 0C>
System Parameters
service
basic setup
```

12.1 Function "tag no." (0C0)

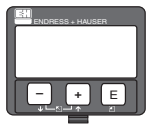

```
tag no. 0C0
```

You can define the tag number with this function.

User input:

- 16 alphanumeric characters for HART instruments (8 using the HART universal command)
- 32 alphanumeric characteristics for PROFIBUS-PA instruments

12.2 Function "device tag" (0C0), FOUNDATION Fieldbus only

This function displays the tag number.

12.3 Function "Profile Version" (0C1), PROFIBUS-PA only

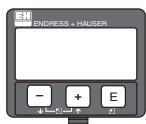

```
Profile Version 0C1
3.0
```

The PA Profile version is shown using this function (Profile 3.0).



Caution!

This function is available for PROFIBUS-PA devices only!

12.4 Function "protocol+sw-no." (0C2)

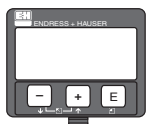

```
Protocol+sw-no. 0C2
001.01.00 HART
```

This function shows the protocol and the hardware and software version: Vxx.yy.zz.prot.

Display:

xx: hw-version

yy: sw-version

zz: sw-revision

prot: protocol type (e.g. HART)

12.5 Function "serial no." (0C4)



This function displays the instrument serial number.

12.6 Function "device id" (0C4), FOUNDATION Fieldbus only

This function displays the instrument serial number.

12.7 Function "distance unit" (0C5)



You can select the basic distance unit with this function.

Selection:

- m
- ft
- mm
- inch

Dependence

m, mm: **"format display" (094)** can only be **"decimal"**.

The units are changed for the following parameters:

- empty calibr. (005)
- full calibr. (006)
- safety distance (015)
- input level (044)
- diameter vessel (047)
- range of mapping (052)
- cust. tank map (055)
- offset (057)
- simulation value (066)
- measured dist. (0A5)
- measured level(0A6)

12.8 Function "temperature unit" (0C6)



In this function you select the temperature unit.

Selection:

- °C
- °F

The unit is changed for the following functions

- Function "measured temp." (030)
- Function "max. temp. limit" (031)
- Function "max. meas. temp" (032)

12.9 Function "download mode" (0C8)

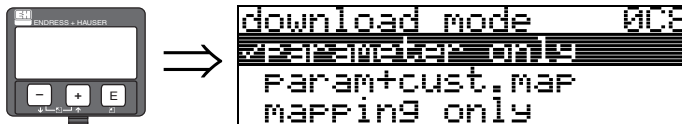

This parameter defines which values are written to the instrument during a FieldCare configuration download.

Selection:

- parameter only
- param+cust.map
- mapping only



Note!

This parameter must not be described explicitly in FieldCare. The various possibilities can be selected from the download dialog.

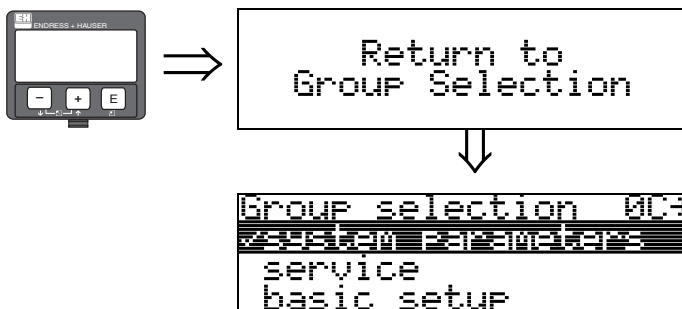

After 3 s, the following message appears

13 Function group "service" (0D)

This function group is reserved for service purposes only.

13.1 Software history

Date	Software version	Changes to software	Documentation
HART			
01.2002 03.2003	V 01.02.00 V 01.02.02	Original software Compatible with: <ul style="list-style-type: none"> ■ ToF Tool ■ Commuwin II (version 2.05.03 and higher) ■ HART Communicator DXR 275 (from OS 4.6) with Rev. 1, DD 1 	BA237F/00/en/01.02 BA237F/00/en/03.03
02.2004	V 01.02.04	<ul style="list-style-type: none"> ■ FMU 42 added ■ compatible with HART Communicator DXR 375 	BA237F/00/en/02.04
07.2006	V01.04.00	<ul style="list-style-type: none"> ■ "detection window" function added can be operated via: <ul style="list-style-type: none"> ■ ToF Tool from version 4.50 ■ HART Communicator DXR375 with Rev. 1, DD11 	BA237F/00/en/07.06
PROFIBUS			
01.2002 03.2003	V 01.02.00 V 01.02.02	Original software Compatible with: <ul style="list-style-type: none"> ■ ToF Tool ■ Commuwin II (version 2.05.03 and higher) ■ HART Communicator DXR 275 (from OS 4.6) with Rev. 1, DD 1 	BA237F/00/en/01.02 BA237F/00/en/03.03
02.2004	V 01.02.04	<ul style="list-style-type: none"> ■ FMU 42 added ■ compatible with HART Communicator DXR 375 	BA237F/00/en/02.04
07.2006	V01.04.00	<ul style="list-style-type: none"> ■ "detection window" function added can be operated via: <ul style="list-style-type: none"> ■ ToF Tool from version 4.50 ■ HART Communicator DXR375 with Rev. 1, DD1 	BA237F/00/en/07.06

Date	Software version	Changes to software	Documentation
FOUNDATION Fieldbus			
01.2002 03.2003	V 01.02.00 V 01.02.02	Original software Compatible with: <ul style="list-style-type: none"> ■ ToF Tool ■ Commuwin II (version 2.05.03 and higher) ■ HART Communicator DXR 275 (from OS 4.6) with Rev. 1, DD 1 	BA237F/00/en/01.02 BA237F/00/en/03.03
02.2004	V 01.02.04	<ul style="list-style-type: none"> ■ FMU 42 added ■ compatible with HART Communicator DXR375 	BA237F/00/en/02.04
V01.04.00	07.2006	<ul style="list-style-type: none"> ■ "detection window" function added <p>can be operated via:</p> <ul style="list-style-type: none"> ■ ToF Tool from version 4.50 ■ HART Communicator DXR375 with Rev. 1, DD1 <p>FOUNDATION Fieldbus Transducer Block divided into:</p> <ul style="list-style-type: none"> ■ Sensor Block ■ Diagnostic Block ■ Display Block <p>Execution time of the function blocks reduced:</p> <ul style="list-style-type: none"> ■ AI: 30 ms ■ PID: 80 ms ■ AR: 50 ms ■ IS: 30 ms ■ SC: 40 ms ■ IT: 60 ms 	BA237F/00/en/07.06

14 Signal evaluation

14.1 Envelope curve

The echo of an ultrasonic impulse does not only contain the desired echo from the product surface, but also interference echoes (e.g. from tank fittings or multiple reflections). In order to identify these echoes one plots the logarithmic amplitude of the echo versus the time-of-flight of the ultrasonic impulse. This plot is called **envelope curve**.

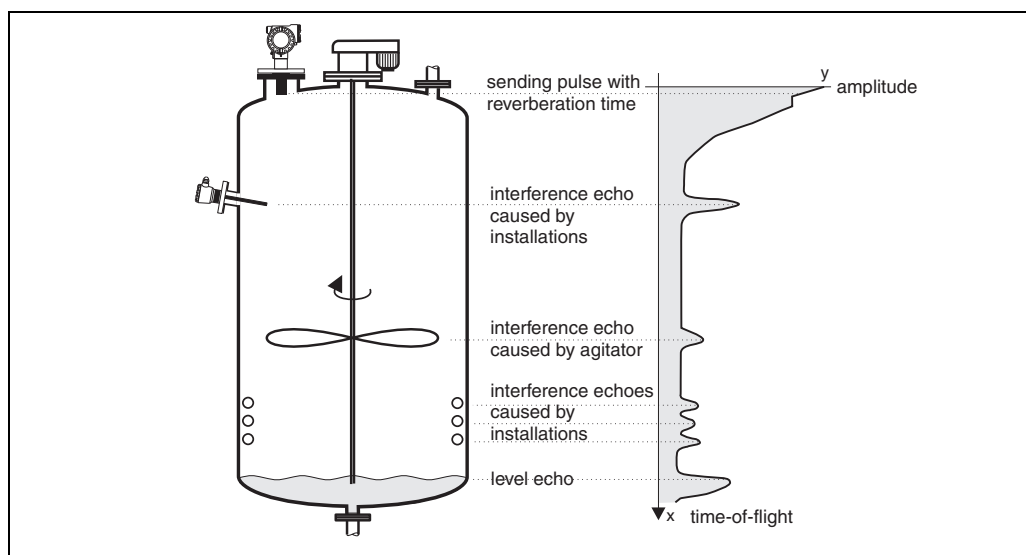

The envelope curve can be displayed in the **"envelope curve" (OE)** function group (see Page 52).

In the FieldCare the envelope curve may also be displayed in the "envelope" menu:

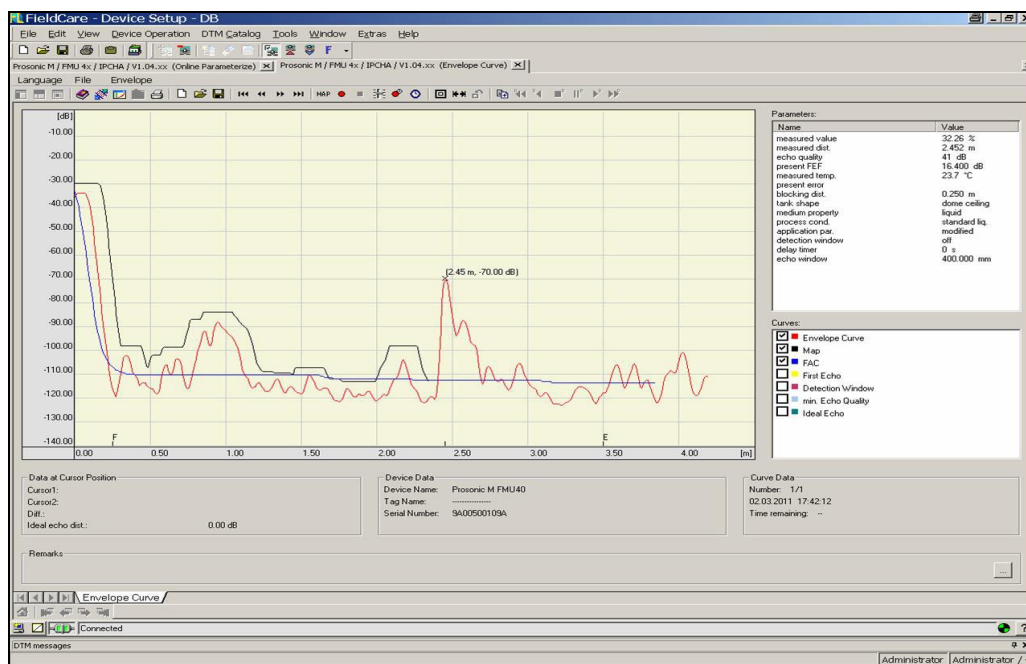

14.2 Interference echo suppression (tank mapping)

The interference echo suppression of the Prosonic M makes sure that interference echoes are not interpreted as the level echo by fault.

In order to carry out the interference echo suppression one must record a time-of-flight dependent threshold (**TDT**), which is also called the **tank map**.

All maxima of the envelope curve which are situated below the TDT are discarded by the signal evaluation procedures.

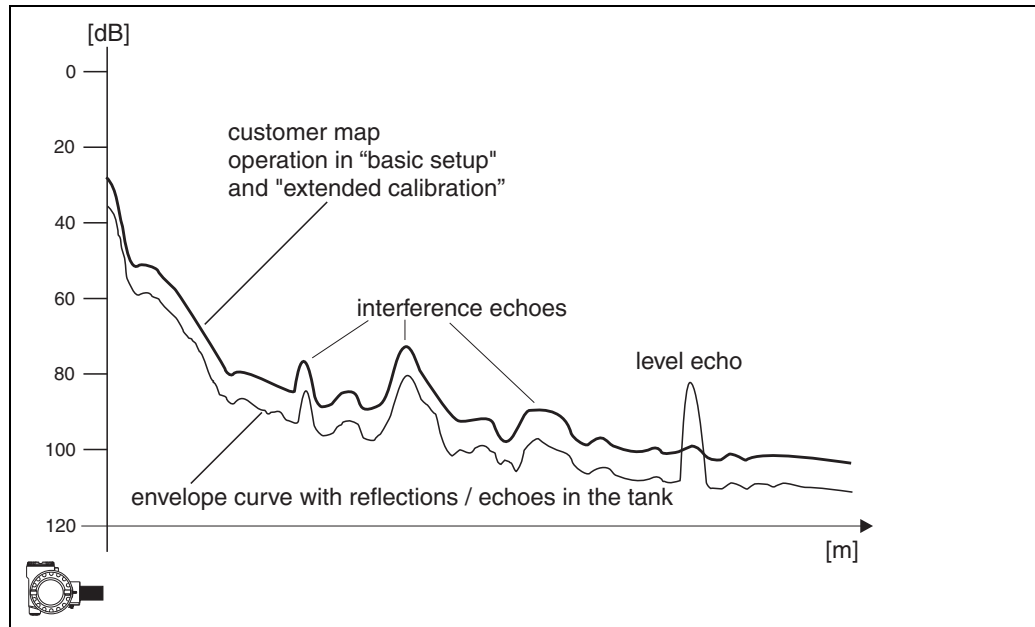

It is recommended to record the tank map when the vessel is as possible empty. Then, the map will include all echoes except the level echo.

But even, if it is not possible to empty the vessel during the commissioning of the Prosonic M, you should perform the map. In this case it is recommended to repeat the record of the mapping at a later time - when the vessel is as possible empty.

The tank map is recorded in the function group "**extended calibration**" (05). Select the option "mapping" in the "**selection**" (050) function.

14.3 Floating Average Curve (FAC)

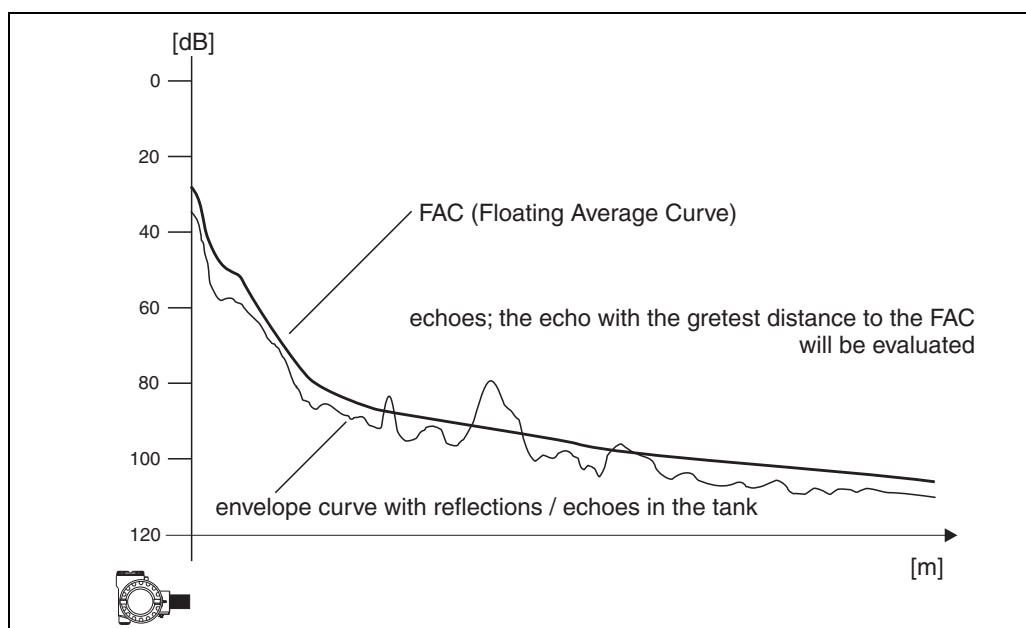

The function of the Floating Average Curve (FAC) is similar to the interference echo suppression. The main difference is, that the tank map is recorded only once whilst the FAC adjusts itself continuously to the changing measuring conditions.

By this procedure changes of the interference echoes (e.g. by build-up) can be compensated for.

In contrast to the tank map, the FAC can only register small interference echoes.

The FAC is always used in the signal evaluation, even if the tank map has been deactivated.



In the envelope curve, the maximum with the largest distance to the FAC is interpreted as the level echo.

15 Trouble shooting

15.1 System error messages

Current error



Errors which the Prosonic M detects during commissioning or operation are displayed:

- In the **"measured value" (000)** function
- In the **"diagnostics" (0A)** function group in the **"present error" (0A0) function** (only the highest priority error is displayed; in the case of multiple errors, you can scroll between the different error messages by pressing  or .)

Last error

The last error is displayed in the **"diagnostics" (0A)** function group in the **"previous error" (0A1) function**. This display can be deleted in the **"clear last error" (0A2) function**.

Types of errors

Type of error	Symbol	Meaning
Alarm (A)	 Continuous	The output signal assumes a value which can be set using the "output on alarm" (010) function: <ul style="list-style-type: none"> ■ MAX: 110%, 22mA ■ MIN: -10%, 3.8mA ■ Hold: last value is on hold ■ User-specific value
Warning (W)	 Flashing	The device continues measurement. An error message is displayed.
Alarm/Warning (E)		You can define whether the error should behave as an alarm or as a warning.

Error codes



Code	Error description (on the display)	Action
A101 A102 A110 A152 A160	checksum error	Reset; If alarm still present after reset, replace electronics
W103	initialising	If the message does not disappear after several seconds, replace the electronics
A106	downloading	Wait Message disappears after load sequence
A111 A113 A114 A115 A121 A125 A155 A164 A171	electronics defect	Reset; Check system for EMC, improve as necessary If alarm still present after reset, replace electronics
A116	download error	Check connection Restart download
W153	initialising	Wait a few seconds; if error is still displayed, switch the power off and on again
A231	sensor defect	Check connection, if necessary replace HF module or electronics
A281	interruption temperature sensor	Exchange sensor
A502	Sensor type not detected	Exchange sensor and/or electronics
W511	no factory calibration	Carry out factory calibration
A512	recording of mapping	Alarm disappears after a few seconds
A521	new sensor type detected	Reset
W601	linearisation curve not monotone	Correct table (enter monotonously increasing table)
W611	less than 2 linearisation points	Enter additional value pairs
W621	simulation on	Switch simulation mode off ["output" (06) function group, "simulation" (065) function]
E641	no usable echo	Check basic calibration (see Page 26)
E651	level in safety distance - risk of overspill	Error disappears when the level leaves the safety distance. Possibly reset the lock. ["safety settings" (01) function group, "ackn. alarm" (017) function]
A661	Sensor overtemperature	
A671	Linearisation incomplete	Activate linearisation table
W681	current out of range	Carry out basic calibration; check linearisation
W691	Filling noise detected, level ramp is active	

15.2 Application errors

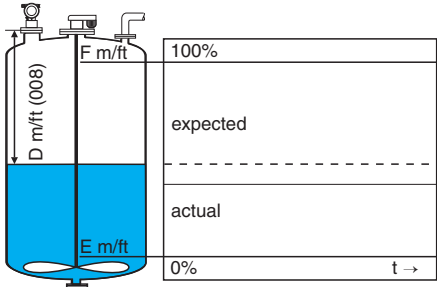
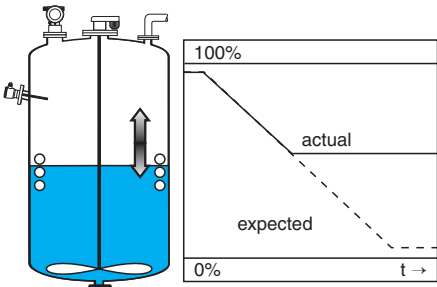
Error	Output	Possible cause	Elimination
A warning or alarm is present.	Depending on the configuration	See Error Codes table (→ 86)	1. See Error Codes table (→ 86)
Measured value (00) is incorrect		Measured distance (008) OK?	yes → 1. Check empty calibration (005) and full calibration (006). 2. Check linearisation: → level/ullage (040) → max. scale(046) → diameter vessel(047) → Check table
		no ↓ Measurement in bypass or stilling well?	yes → 1. In tank shape(002) is bypass or stilling well selected?
		no ↓ An interference echo might be under evaluation.	yes → 1. Carry out interference echo suppression → basic setup
No change in measured value on filling/emptying		Interference echoes from fixings, nozzles or build-up on sensor membrane	1. Carry out interference echo suppression → basic setup 2. Clean sensor if necessary 3. If necessary, select better installation position. 4. If necessary due to wide interference echoes, set function "detection window" (0A7) to "off".

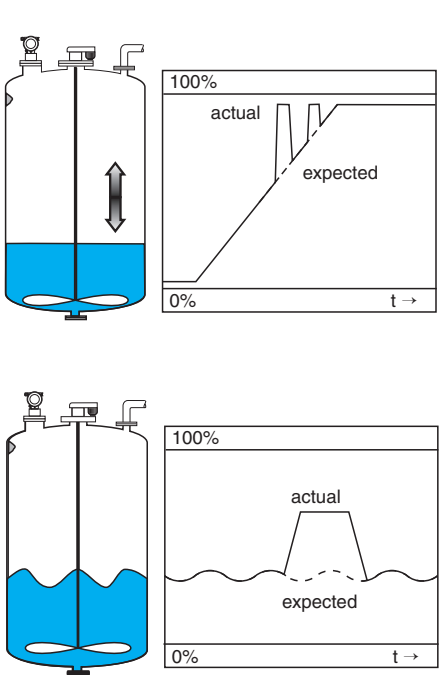
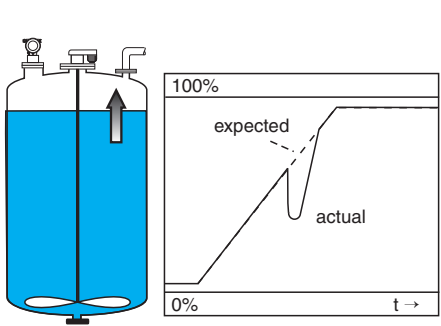
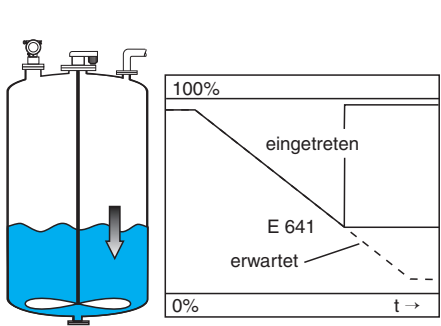
Error	Output	Possible cause	Elimination
<p>With an uneven surface (e.g. filling, emptying, running agitator) the measured value may jump sporadically to higher levels</p>		<p>Signal is weakened by uneven surface — periodically interference echos, e.g. from internals, are stronger</p>	<ol style="list-style-type: none"> 1. Carry out interference echo suppression → basic setup 2. Set the process cond. (004) to "calm surface" or "add. agitator" 3. Increase output damping (058) 4. If necessary, select a different installation position and/or a larger sensor
<p>On filling/emptying the measured value drops</p>		<p>Multiple echos</p>	<p>yes →</p> <ol style="list-style-type: none"> 1. Check tank shape (002), e.g. "dome ceiling" or "horizontal cyl." 2. In the blocking distance range (059) there is no echo evaluation 3. If possible, do not select a central installation position 4. Possible user stilling well/echo guide pipe
<p>E 641 (echo loss)</p>		<p>Level echo is too weak. Possible causes:</p> <ul style="list-style-type: none"> ■ Uneven surface through filling/emptying ■ Active agitator ■ Foam ■ Sensor not aligned parallel to product surface 	<p>yes →</p> <ol style="list-style-type: none"> 1. Check application parameters (002), (003) and (004) 2. If necessary, select a different installation position and/or a larger sensor 3. Align the sensor parallel to the product surface (particularly for bulk solids applications)

Index function menu

Function group

00 = basic setup	17
01 = safety settings	25
03 = temperature	33
04 = linearisation	35
05 = extended calibr.	43
06 = output	49
06 = profibus param. (PROFIBUS-PA only)	49
09 = display	63
0A = diagnostics	67
0C = system parameter	75

Function

000 = measured value.	17
002 = tank shape	17
003 = medium property	18
004 = process cond.	18
005 = empty calibr.	20
006 = full calibr.	21
008 = display	21
010 = output on alarm	25
011 = output on alarm (HART only)	27
012 = outp. echo loss	27
013 = ramp %span/min	28
014 = delay time.	29
015 = safety distance.	29
016 = in safety dist.	30
017 = ackn. alarm.	32
030 = measured temperature	33
031 = max. temp. limit	33
032 = max. meas. temp.	33
033 = react. high temp	34
034 = defect temp. sens.	34
040 = level/ullage	35
041 = linearisation	36
042 = customer unit	40
043 = table no.	41
044 = input level	41
045 = input volume	42
046 = max. scale.	42
047 = diameter vessel	42
050 = selection	43
051 = check distance	43
052 = range of mapping	44
053 = start mapping	44
054 = pres. map dist.	45
055 = cust. tank map	46
056 = echo quality	46

057 = offset	47
058 = output damping	47
059 = blocking dist.	47
060 = commun. address (HART only)	49
060 = instrument addr. (PROFIBUS-PA only)	49
061 = no. of preambels (HART only)	50
061 = ident number (PROFIBUS-PA only)	50
062 = thres. main val. (HART only)	51
062 = set unit to bus (PROFIBUS-PA only)	51
063 = fixed current (HART only)	53
063 = out value (PROFIBUS-PA only)	52
064 = fixed cur. value (HART only)	53
064 = out status (PROFIBUS-PA only)	53
065 = simulation	54
066 = simulation value	55
067 = output current (HART only)	56
067 = 2nd cyclic value (PROFIBUS-PA only)	56
068 = select v0h0 (PROFIBUS-PA only)	57
069 = display value (PROFIBUS-PA only)	57
092 = language	63
093 = back to home	63
094 = format display	64
095 = no.of decimals	64
096 = sep. character	64
097 = display test	65
0A0 = present error	68
0A1 = previous error	68
0A2 = clear last error	68
0A3 = reset	69
0A4 = unlock parameter	71
0A5 = measured dist.	72
0A6 = measured level	73
0A7 = detection window	73
0A8 = application par.	74
0C0 = tag no.	75
0C0 = device tag (FOUNDATION Fieldbus only)	75
0C1 = Profile Version (PROFIBUS-PA only)	75
0C2 = protocol+sw-no.	75
0C4 = serial no.	76
0C4 = device id (FOUNDATION Fieldbus only)	76
0C5 = distance unit	76
0C6 = temperature unit	77
0C8 = download mode	77
0E1 = plot settings	59
0E2 = recording curve	59
0E3 = envelope curve	60
D00 = service level	79

www.endress.com/worldwide

Endress + Hauser 

People for Process Automation

BA00240F/00/EN/13.12
71164400
FM+SGML 9.0

