

Operating Instructions

Liquisys M CPM223/253

Transmitter for pH and ORP

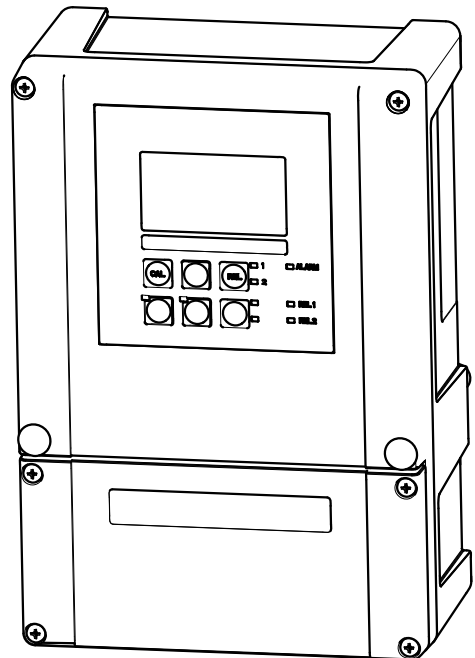
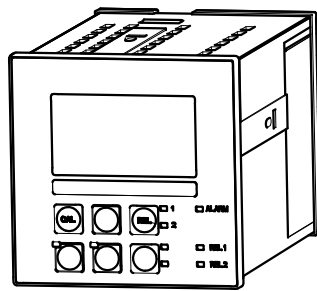





Table of contents

1	Document information	5	6	Operation options	31
1.1	Warnings	5	6.1	Quick operation guide	31
1.2	Symbols used	5	6.2	Display and operating elements	31
1.3	Symbols on the device	5	6.2.1	Display	31
1.4	Electrical symbols	6	6.2.2	Operating elements	33
2	Basic safety instructions	7	6.2.3	Key functions	33
2.1	Requirements for personnel	7	6.3	Local operation	35
2.2	Designated use	7	6.3.1	Automatic/manual mode	35
2.3	Occupational safety	7	6.3.2	Operating concept	36
2.4	Operational safety	8	7	Commissioning	38
2.5	Product safety	8	7.1	Specificities of commissioning digital electrodes	38
2.5.1	State of the art	8	7.2	Specificities of commissioning ISFET sensors ..	38
2.5.2	IT security	8	7.3	Function check	38
3	Incoming acceptance and product identification	9	7.4	Switching on	39
3.1	Incoming acceptance	9	7.5	Quick Setup	41
3.2	Scope of delivery	9	7.6	Device configuration	43
3.3	Product identification	10	7.6.1	Setup 1 (pH/ORP)	43
3.3.1	Nameplate	10	7.6.2	Setup 2 (temperature)	45
3.3.2	Product identification	10	7.6.3	Current input	45
3.4	Certificates and approvals	10	7.6.4	Current outputs	49
3.4.1	CE mark	10	7.6.5	Alarm	53
3.4.2	CSA General Purpose	10	7.6.6	Check	54
4	Installation	11	7.6.7	Relay configuration	58
4.1	Installation at a glance	11	7.6.8	Service	73
4.1.1	Measuring system	12	7.6.9	E+H Service	75
4.2	Installation conditions	13	7.6.10	Interfaces	76
4.2.1	Field device	13	7.6.11	Communication	76
4.2.2	Panel-mounted device	14	7.7	Calibration	77
4.3	Installation instructions	15	7.7.1	Numeric calibration	82
4.3.1	Field device	15	7.7.2	Offset	82
4.3.2	Panel-mounted device	17	8	Diagnostics and troubleshooting ...	84
4.4	Post-installation check	17	8.1	Trouble shooting instructions	84
5	Electrical connection	18	8.2	System error messages	84
5.1	Wiring	18	8.3	Process-specific errors	88
5.2	Electrical connection without Memosens functionality	18	8.4	Device-specific errors	91
5.2.1	Wiring diagram	18	9	Maintenance	93
5.2.2	Measuring cables and sensor connection	21	9.1	Maintenance of the entire measuring point ..	94
5.3	Electrical connection with Memosens functionality	25	9.1.1	Cleaning the transmitter	94
5.3.1	Wiring diagram	25	9.1.2	Cleaning the pH/ORP electrodes	94
5.3.2	Measuring cables and sensor connection	28	9.1.3	Maintenance of digital sensors	95
5.4	Alarm contact	30	9.1.4	Liquid KCl supply	96
5.5	Post-connection check	30	9.1.5	Assembly	96
			9.1.6	Connecting cables and junction boxes	96
			10	Repair	98
			10.1	Spare parts	98
			10.2	Disassembling the panel-mounted device	98
			10.3	Disassembling the field device	101



10.4	Replacing the central module	104
10.5	Return	105
10.6	Disposal	105
11	Accessories	106
11.1	Sensors	106
11.1.1	pH glass electrodes	106
11.1.2	pH ISFET sensors	106
11.1.3	ORP sensors	107
11.1.4	Sensor simulators	108
11.2	Connection accessories	108
11.3	Installation accessories	109
11.4	Software and hardware add-ons	110
11.5	Buffer solutions	110
12	Technical data	111
12.1	Input	111
12.2	Output	111
12.3	Power supply	114
12.4	Performance characteristics	115
12.5	Environment	115
12.6	Mechanical construction	116
13	Appendix	117
Index	122

1 Document information

1.1 Warnings

Structure of information	Meaning
 DANGER Causes (/consequences) Consequences of non-compliance (if applicable) ► Corrective action	This symbol alerts you to a dangerous situation. Failure to avoid the dangerous situation will result in a fatal or serious injury.
 WARNING Causes (/consequences) Consequences of non-compliance (if applicable) ► Corrective action	This symbol alerts you to a dangerous situation. Failure to avoid the dangerous situation can result in a fatal or serious injury.
 CAUTION Causes (/consequences) Consequences of non-compliance (if applicable) ► Corrective action	This symbol alerts you to a dangerous situation. Failure to avoid this situation can result in minor or more serious injuries.
 NOTICE Cause/situation Consequences of non-compliance (if applicable) ► Action/note	This symbol alerts you to situations which may result in damage to property.











1.2 Symbols used

-  Additional information, tips
-  Permitted or recommended
-  Forbidden or not recommended

1.3 Symbols on the device

Symbol	Meaning
	Reference to device documentation

1.4 Electrical symbols

Symbol	Meaning
 A0027423	Direct current A terminal at which DC is present or through which DC flows.
 A0027424	Alternating current A terminal at which alternating voltage (sine-wave) is applied or through which alternating current flows.
 A0027425	Direct current or alternating current A terminal at which direct voltage or alternating voltage is present or through which direct current or alternating current flows.
 A0027426	Ground connection A terminal which, from the user's point of view, is already grounded via a grounding system.
 A0027427	Protective ground connection A terminal which must be connected to ground prior to establishing any other connections.
 A0019929	Class II equipment Reinforced or double insulation
 A0027420	Alarm relay
 A0027428	Input
 A0027429	Output
 A0027430	DC voltage source
 A0027431	Temperature sensor

2 Basic safety instructions

2.1 Requirements for personnel

- Installation, commissioning, operation and maintenance of the measuring system may be carried out only by specially trained technical personnel.
- The technical personnel must be authorized by the plant operator to carry out the specified activities.
- The electrical connection may be performed only by an electrical technician.
- The technical personnel must have read and understood these Operating Instructions and must follow the instructions contained therein.
- Measuring point faults may be repaired only by authorized and specially trained personnel.

 Repairs not described in the Operating Instructions provided may only be carried out directly by the manufacturer or by the service organization.

2.2 Designated use

Liquisys M is a transmitter for determining the pH value and/or the oxidation-reduction potential.

The transmitter is particularly suited for use in the following areas:

- Chemical industry
- Pharmaceutical industry
- Food industry
- Drinking water treatment
- Condensate treatment
- Municipal wastewater treatment plants
- Water treatment
- Electroplating

Use of the device for any purpose other than that described, poses a threat to the safety of people and of the entire measuring system and is therefore not permitted.

The manufacturer is not liable for damage caused by improper or non-designated use.

2.3 Occupational safety

As the user, you are responsible for complying with the following safety conditions:

- Installation guidelines
- Local standards and regulations

Electromagnetic compatibility

- The product has been tested for electromagnetic compatibility in accordance with the applicable European standards for industrial applications.
- The electromagnetic compatibility indicated applies only to a product that has been connected in accordance with these Operating Instructions.

2.4 Operational safety

1. Before commissioning the entire measuring point, verify that all connections are correct. Ensure that electrical cables and hose connections are undamaged.
2. Do not operate damaged products, and safeguard them to ensure that they are not operated inadvertently. Label the damaged product as defective.
3. If faults cannot be rectified:
Take the products out of operation and safeguard them to ensure that they are not operated inadvertently.

2.5 Product safety

2.5.1 State of the art

The product is designed to meet state-of-the-art safety requirements, has been tested, and left the factory in a condition in which it is safe to operate. The relevant regulations and European standards have been observed.

2.5.2 IT security

We only provide a warranty if the device is installed and used as described in the Operating Instructions. The device is equipped with security mechanisms to protect it against any inadvertent changes to the device settings.

IT security measures in line with operators' security standards and designed to provide additional protection for the device and device data transfer must be implemented by the operators themselves.

3 Incoming acceptance and product identification

3.1 Incoming acceptance

1. Verify that the packaging is undamaged.
 - ↳ Notify your supplier of any damage to the packaging.
Keep the damaged packaging until the matter has been settled.
2. Verify that the contents are undamaged.
 - ↳ Notify your supplier of any damage to the delivery contents.
Keep the damaged products until the matter has been settled.
3. Check the delivery for completeness.
 - ↳ Check it against the delivery papers and your order.
4. Pack the product for storage and transportation in such a way that it is protected against impact and moisture.
 - ↳ The original packaging offers the best protection.
The permitted ambient conditions must be observed (see "Technical data").

If you have any questions, please contact your supplier or your local sales center.

3.2 Scope of delivery

The delivery of the field device comprises:

- 1 transmitter CPM253
- 1 plug-in screw terminal, 3-pin
- 1 cable gland Pg 7
- 1 cable gland Pg 16 reduced
- 2 cable glands Pg 13.5
- 1 set of Operating Instructions
- For versions with HART communication:
 - 1 set of Operating Instructions: Field communication with HART
- For versions with PROFIBUS interface:
 - 1 set of Operating Instructions: Field communication with PROFIBUS PA/DP

The delivery of the panel-mounted device comprises:

- 1 transmitter CPM223
- 1 set of plug-in screw terminals
- 2 tensioning screws
- 1 BNC connector (solder-free measuring cable connection)
- 1 set of Operating Instructions
- For versions with HART communication:
 - 1 set of Operating Instructions: Field communication with HART
- For versions with PROFIBUS interface:
 - 1 set of Operating Instructions: Field communication with PROFIBUS PA/DP

3.3 Product identification

3.3.1 Nameplate

The nameplate provides you with the following information on your device:

- Manufacturer identification
- Order code
- Extended order code
- Serial number
- Ambient and process conditions
- Input and output values
- Safety information and warnings

 Compare the data on the nameplate with your order.

3.3.2 Product identification

The order code and serial number of your product can be found in the following locations:

- On the nameplate
- In the delivery papers

Obtaining information on the product

1. Go to the product page for your product on the Internet.
2. In the navigation area on the right-hand side, select "Check your device features" under "Device support".
 - ↳ An additional window opens.
3. Enter the order code from the nameplate into the search field.
 - ↳ You will receive information on each feature (selected option) of the order code.

3.4 Certificates and approvals

3.4.1 CE mark

The product meets the requirements of the harmonized European standards. As such, it complies with the legal specifications of the EC directives. The manufacturer confirms successful testing of the product by affixing to it the **CE** mark.

3.4.2 CSA General Purpose

The following device versions meet the requirements of CSA and ANSI/UL for Canada and the US:

- CPM253-**2/3/7***
- CPM223-**2/3/7***

4 Installation

4.1 Installation at a glance

Proceed as follows to completely install the measuring point:

- Install the transmitter (see the "Installation instructions" section).
- If the sensor is not yet installed in the measuring point, install it (see Technical Information of the sensor).
- Connect the sensor to the transmitter as illustrated in the "Electrical connection" section.
- Connect the transmitter as illustrated in the "Electrical connection" section.
- Commission the transmitter as explained in the "Commissioning" section.

4.1.1 Measuring system

A complete measuring system comprises:

- Transmitter Liquisys M CPM223 or CPM253
- pH or ORP sensor with or without an integrated temperature sensor
- Immersion, flow or retractable assembly
- pH measuring cable (e.g. CPK9)

Optionally:

- Extension cable, junction box VBA or VBM
- Weather protection cover CY101 for field housing

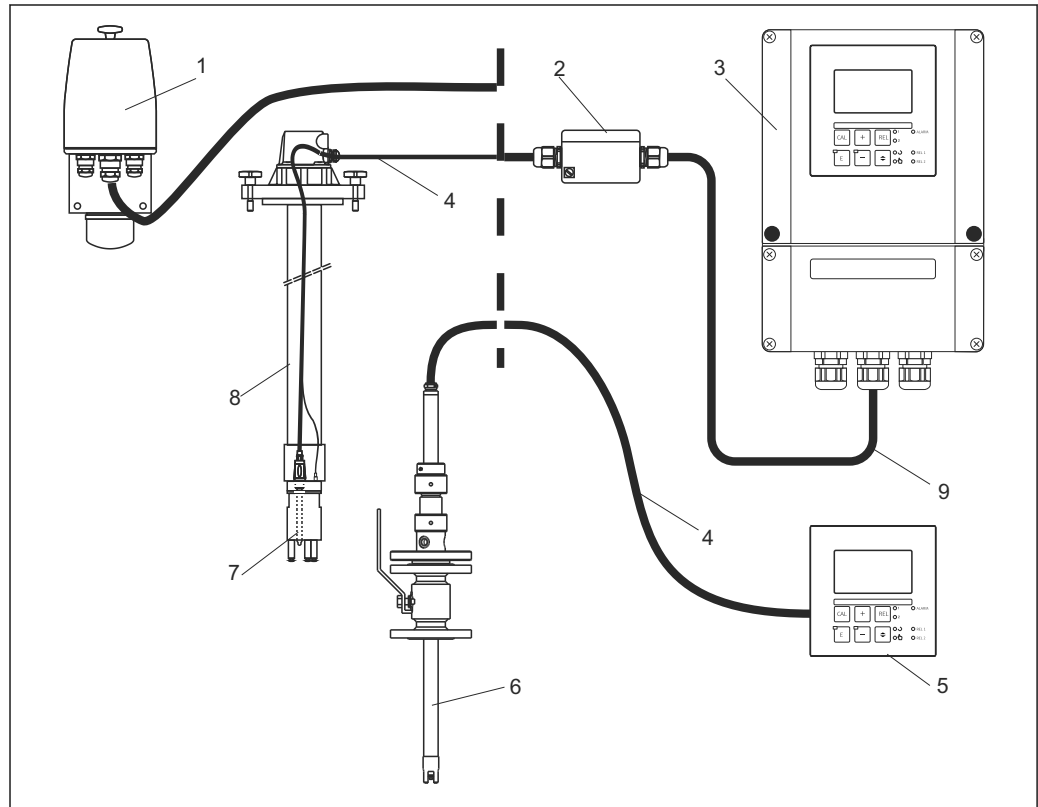

A0024634

1 Complete measuring systems

- 1 Flow assembly CPA250
- 2 Junction box VBA
- 3 Liquisys M CPM253
- 4 Measuring cable e.g. CPK9
- 5 Liquisys M CPM223
- 6 Retractable assembly Cleanfit W CPA450
- 7 Electrode, e.g. Orbisint CPS11
- 8 Immersion assembly CPA111
- 9 Extension cable

4.2 Installation conditions

4.2.1 Field device

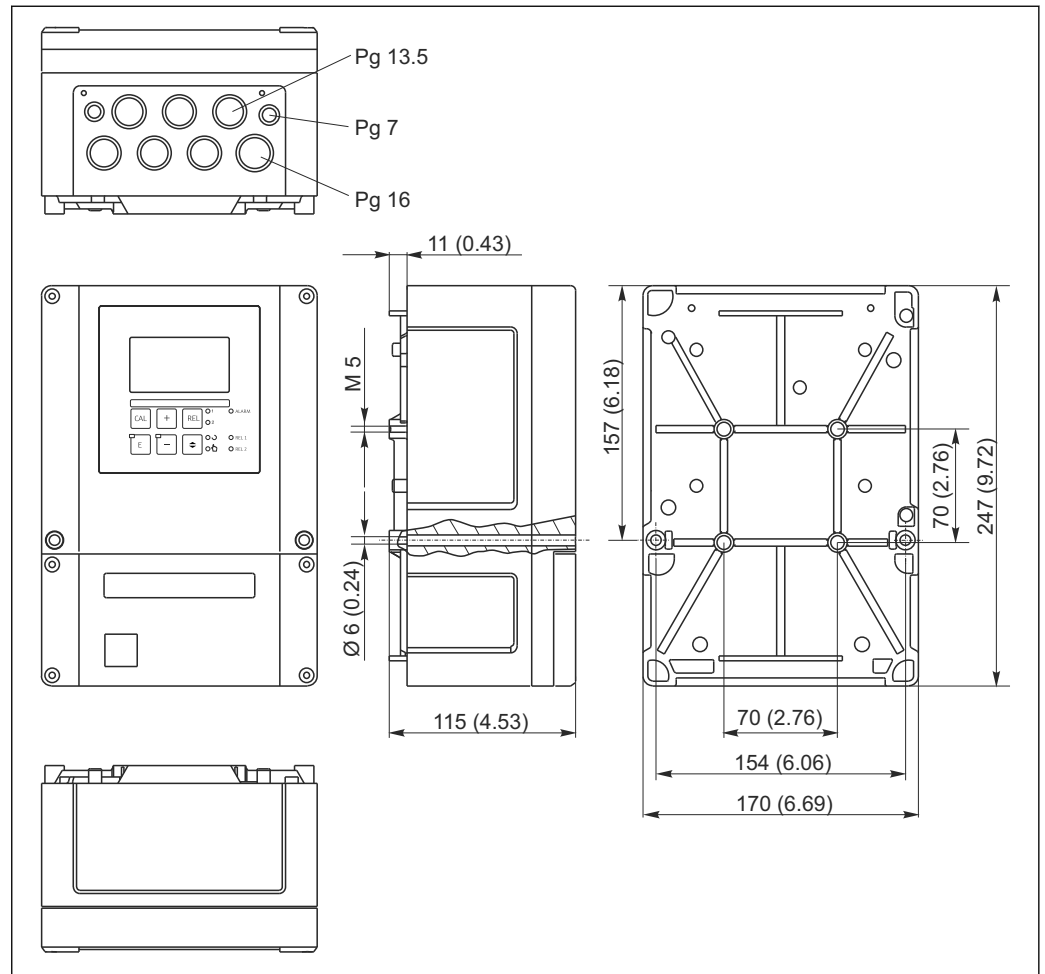

2 Field device, dimensions in mm (inch)

- i** There is a hole in the perforation for the cable entry (connection of supply voltage). It serves as a pressure balance during air shipment. Make sure no moisture penetrates the inside of the housing before the cable installation. The housing is completely air-tight after cable installation.

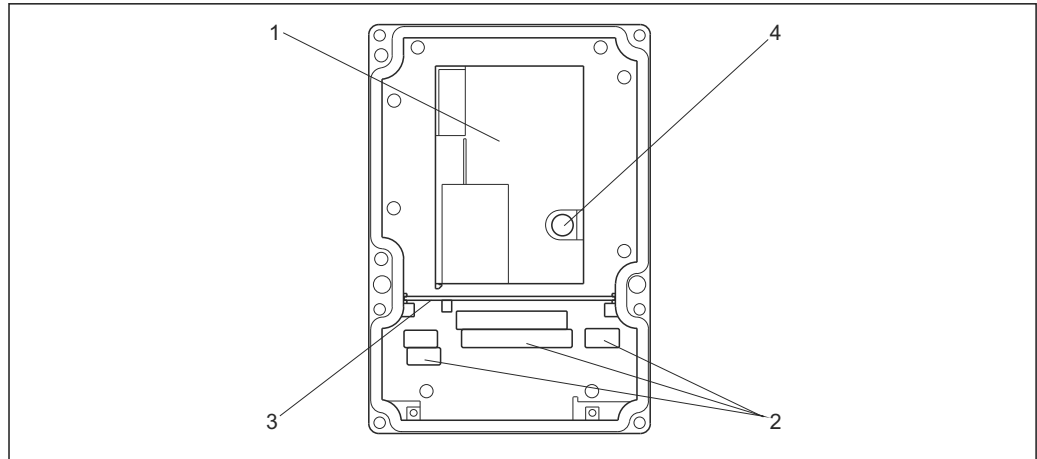

A0024640

3 View into the field housing

- 1 Removable electronics box
- 2 Terminals
- 3 Partition plate
- 4 Fuse

4.2.2 Panel-mounted device

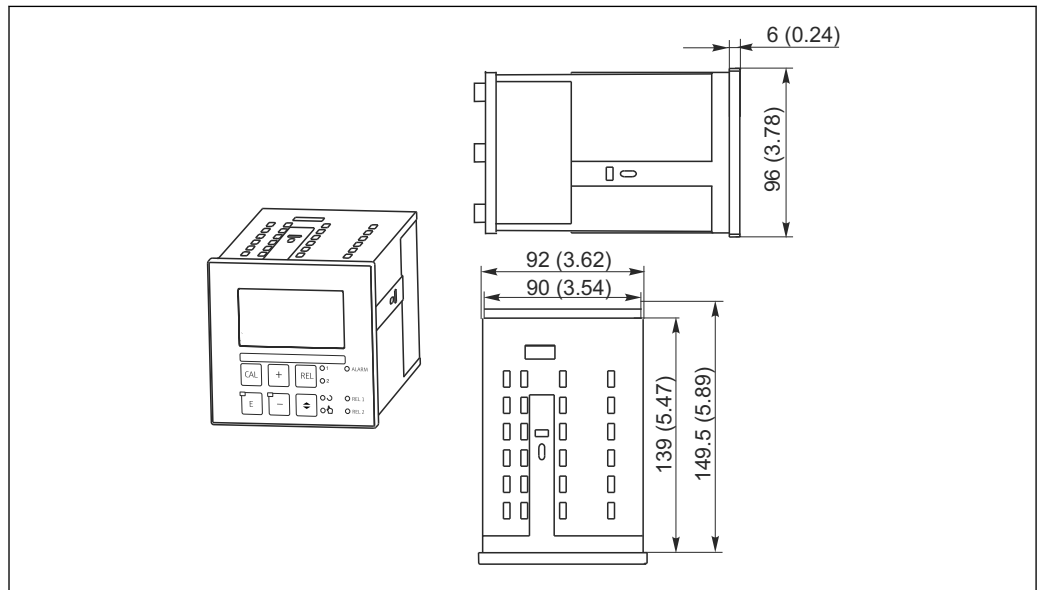

A0024641

4 Panel-mounted device, dimensions in mm (inch)

4.3 Installation instructions

4.3.1 Field device

There are several ways of securing the field housing:

- Wall mounting with fixing screws
- Post mounting to cylindrical pipes
- Post mounting to a square securing mast

NOTICE

Effect of climatic conditions (rain, snow, direct sunlight etc.)

Impaired operation to complete transmitter failure

- ▶ When installing outside, always use the weather protection cover (accessory).

Transmitter wall mounting

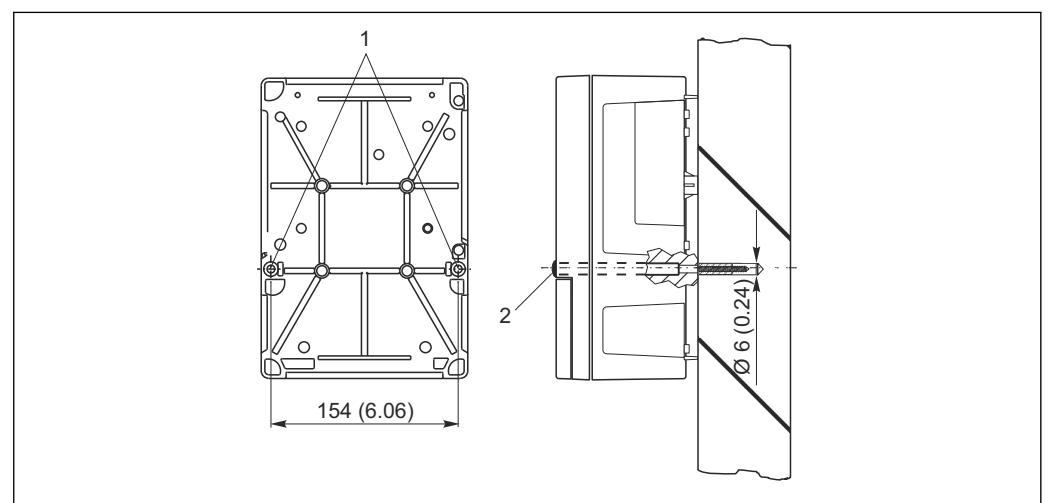

A0024638

5 Field device wall mounting

- 1 Fixing bore holes
- 2 Plastic caps

Proceed as follows to mount the transmitter on the wall:

- Create the bore holes as shown in → 5.
- Drive two fixing screws through the fixing bore holes (1) from the front.
- Mount the transmitter on the wall as shown.
- Cover the bores with plastic caps (2).

Transmitter post mounting

- i** You require a post mounting kit to secure the field device to horizontal and vertical posts or pipes (max. Ø 60 mm (2.36")). This can be acquired as an accessory (see the "Accessories" section).

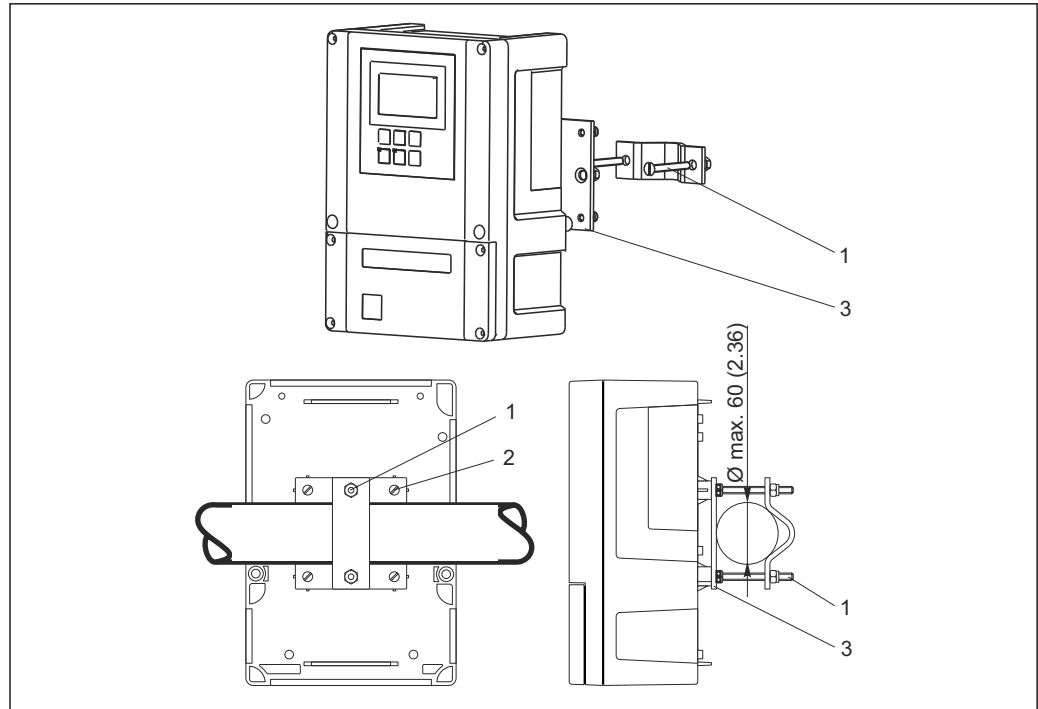

A0024635

6 Field device on horizontal or vertical pipes

- 1 Securing screws
- 2 Fixing screws
- 3 Securing plate

Proceed as follows to mount the transmitter on a post:

1. Guide the two securing screws (1) of the mounting kit through the openings on the securing plate (3).
2. Screw the securing plate onto the transmitter using the four fixing screws (2).
3. Secure the bracket with the field device on the post or pipe using the clip.

You can also secure the field device to the Flexdip CYH112 bracket in conjunction with the weather protection cover. These can be acquired as accessories, see the "Accessories" section.

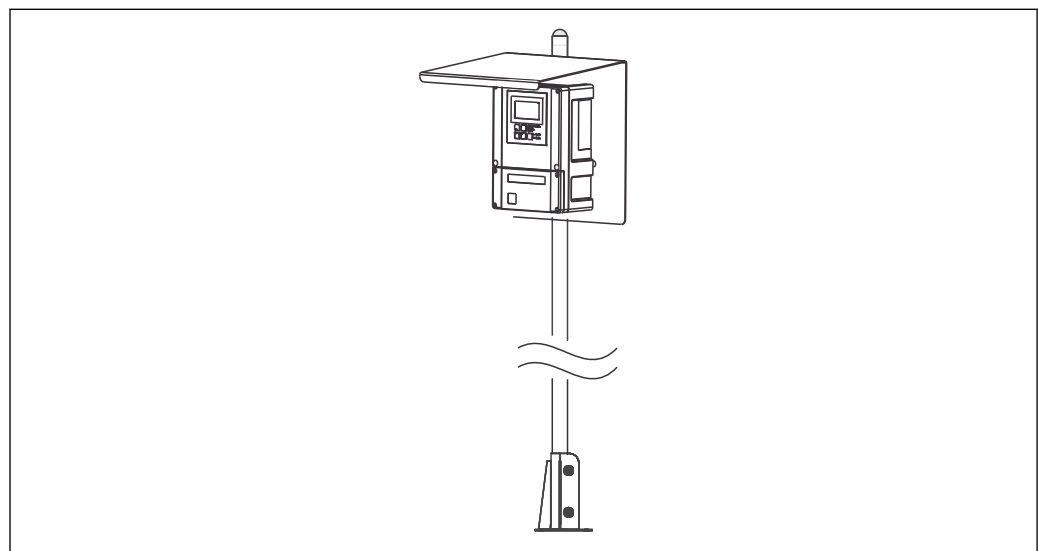

A0027433

7 Field device on Flexdip CYH112 bracket with weather protection cover

4.3.2 Panel-mounted device

The panel-mounted device is secured with the tensioning screws supplied →  8

The necessary installation depth is approx. 165 mm (6.50").

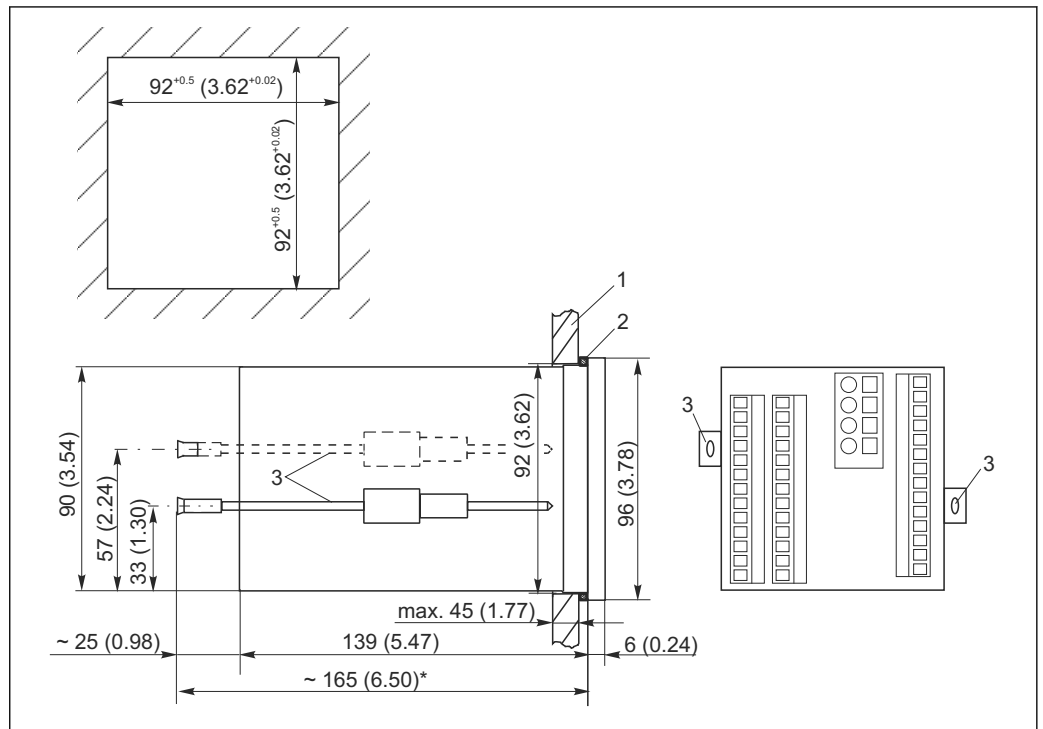

 8 Dimensions in mm (inch)

1 Mounting plate

2 Seal

3 Tensioning screws

* Necessary installation depth

4.4 Post-installation check

- After installation, check the transmitter for damage.
- Check whether the transmitter is protected against moisture and direct sunlight (e.g. by the weather protection cover).

5 Electrical connection

⚠ WARNING

Device is live

Incorrect connection may result in injury or death.

- ▶ The electrical connection may be performed only by an electrical technician.
- ▶ The electrical technician must have read and understood these Operating Instructions and must follow the instructions contained therein.
- ▶ **Prior** to commencing connection work, ensure that no voltage is present on any cable.

5.1 Wiring

⚠ WARNING

Risk of electric shock!

- ▶ At the supply point, the power supply must be isolated from dangerous live cables by double or reinforced insulation in the case of devices with a 24 V power supply.

NOTICE

The device does not have a power switch

- ▶ The customer must provide a protected circuit breaker in the vicinity of the device.
- ▶ The circuit breaker must be a switch or power switch, and you must label it as the circuit breaker for the device.

The electrical connection of the transmitter differs depending on the device version:

- If you are using a device without Memosens functionality, please read the instructions in the "Electrical connection without Memosens functionality" section.
- If you are using a device with Memosens functionality, please read the instructions in the "Electrical connection with Memosens functionality" section.

5.2 Electrical connection without Memosens functionality

5.2.1 Wiring diagram

The wiring diagram shows the connections of a device equipped with all the options. The connection of the sensors to the various measuring cables is explained in more detail in the "Measuring cables and sensor connection" section.

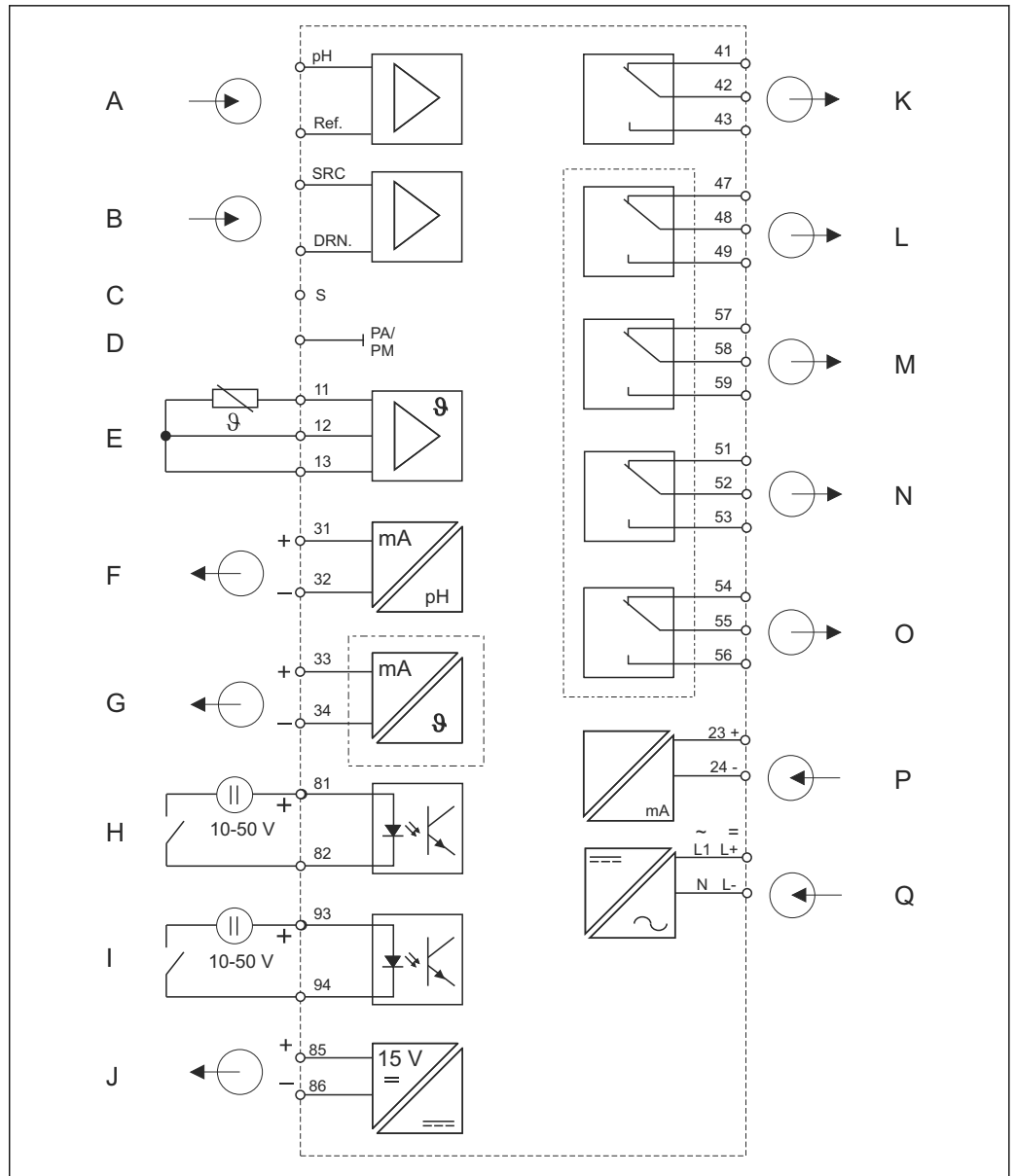

A0026018

9 Electrical connection of the transmitter without Memosens functionality

- | | |
|--|--|
| <p>A Standard sensor</p> <p>B ISFET sensor</p> <p>C Outer shield connection with glass electrodes</p> <p>D Potential equalization</p> <p>E Temperature sensor</p> <p>F Signal output 1 pH/ORP</p> <p>G Signal output 2 temperature, pH/ORP or controller</p> <p>H Binary input 1 (hold)</p> <p>I Binary input 2 (Chemoclean)</p> | <p>J Auxiliary voltage output</p> <p>K Alarm (current-free contact position)</p> <p>L Relay 1 (current-free contact position)</p> <p>M Relay 2 (current-free contact position)</p> <p>N Relay 3 (current-free contact position)</p> <p>O Relay 4 (current-free contact position)</p> <p>P Current input 4 to 20 mA</p> <p>Q Power connection</p> |
|--|--|

Please note the following:

- The device is approved for protection class II and is generally operated without a protective ground connection.
- To guarantee measuring stability and functional safety, you must ground the outer shield of the sensor cable:
 - Glass electrodes (PR/PS device version): terminal "S"
 - ISFET sensors (IS device version): PE distributor rail
 This is on the cover frame in the case of panel-mounted devices, and in the connection compartment in the case of field devices.
- Ground the PE distributor rail or the ground terminal.

Field device connection

Guide the measuring cables through the PG glands into the housing. Connect the measuring cables in accordance with the terminal assignment.

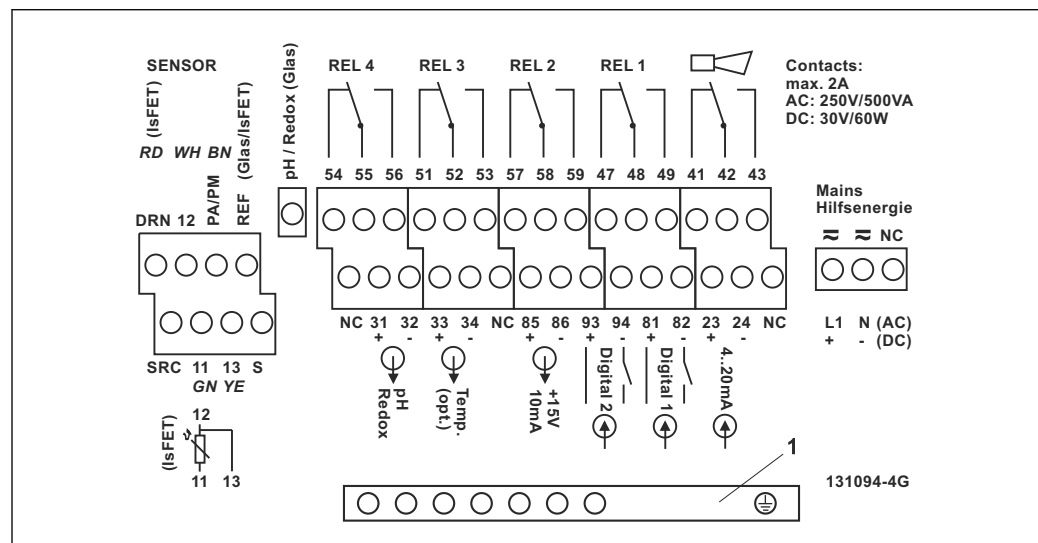

10 Field device connection compartment sticker

1 PE distributor rail for IS device version

NOTICE

Non-observance could cause incorrect measurement

- ▶ Make absolutely sure to protect the cable ends and terminals from moisture.
- ▶ Terminals marked NC may not be connected.
- ▶ Unmarked terminals may not be connected.

i Please label the sensor terminal block with the sticker provided.

Panel-mounted device connection

To connect the panel-mounted device, connect the cables in accordance with the terminal assignment to the terminals on the rear of the device.

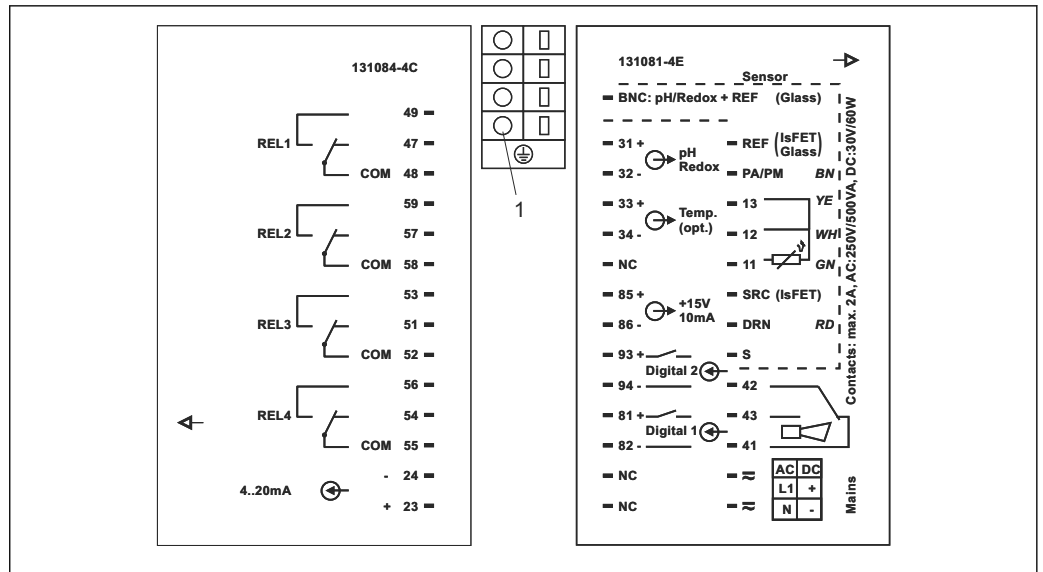

A0026020

11 Panel-mounted device connection sticker

1 Ground terminal for IS device version

NOTICE

Non-observance could cause incorrect measurement

- ▶ Make absolutely sure to protect the cable ends and terminals from moisture.
- ▶ Terminals marked NC may not be connected.
- ▶ Unmarked terminals may not be connected.

i Please label the sensor terminal block with the sticker provided.

5.2.2 Measuring cables and sensor connection

You require shielded special measuring cables to connect pH and ORP electrodes to the transmitter. The following multi-core, pre-terminated cable types can be used:

Sensor type	Cable	Extension
Electrode without temperature sensor	CPK1	VBA / VBM box + CYK71 cable
Electrode with temperature sensor Pt 100 and TOP 68 plug-in head	CPK9	VBA / VBM box + CYK71 cable
ISFET sensor with temperature sensor Pt 100 / Pt 1000 and TOP 68 plug-in head	CPK12	VBA / VBM box + CYK12 cable
pH individual electrode with separate reference electrode and separate temperature sensor	CPK2	VBA / VBM box + PMK cable

Structure and termination of the measuring cables

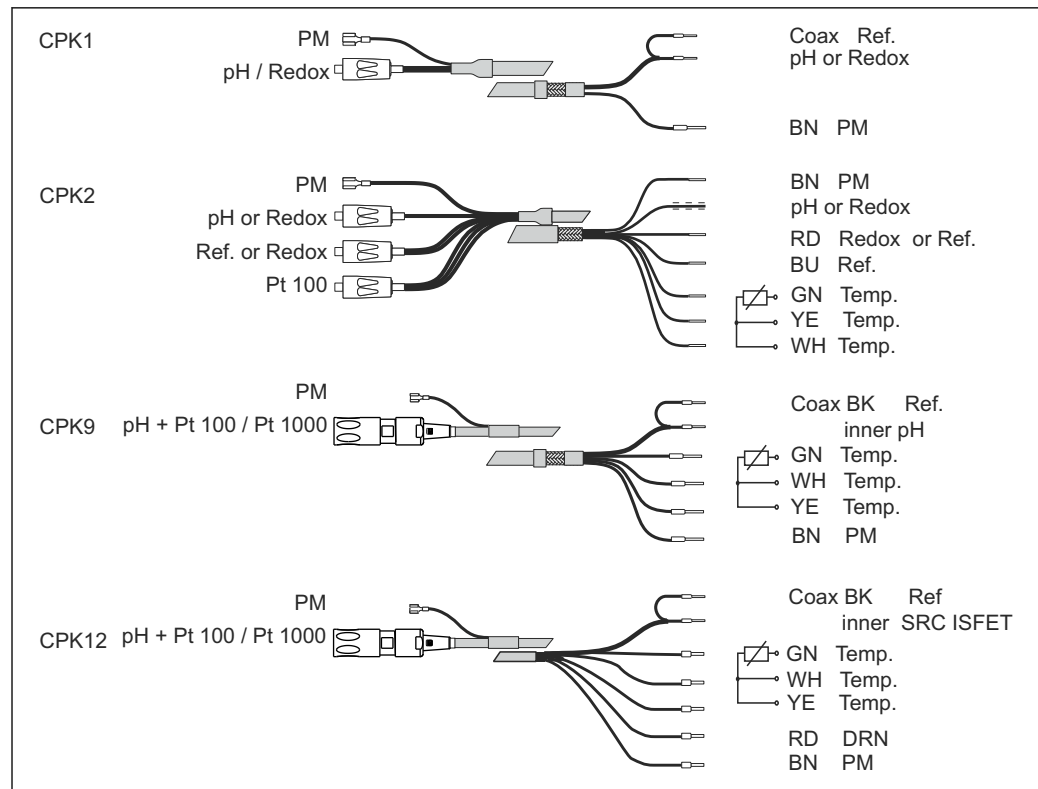

A0027564-EN

12 Structure of the special measuring cables

i For further information on the cables and junction boxes, please refer to the "Accessories" section.

Field device measuring cable connection

Proceed as follows to connect a pH electrode to the field device:

1. Open the housing cover to access the terminal block in the connection compartment.
2. Break through the perforation for a cable gland, mount a Pg gland and guide the cable through this Pg gland.
3. Connect the cable in accordance with the terminal assignment.
4. Tighten the Pg gland.

NOTICE

Moisture can cause incorrect measurements

- Make absolutely sure to protect the connectors, cable ends and terminals from moisture.

Panel-mounted device measuring cable connection

To connect a pH electrode to the panel-mounted device, connect the cable in accordance with the terminal assignment to the terminals on the rear of the device.

If you are using glass electrodes with the panel-mounted device, you have to terminate the measuring cable with a BNC connector. A solder-free BNC connector is supplied with the device. To do this, proceed as follows:

1. Cut off end ferrules 2 and 3 of the coaxial cable.

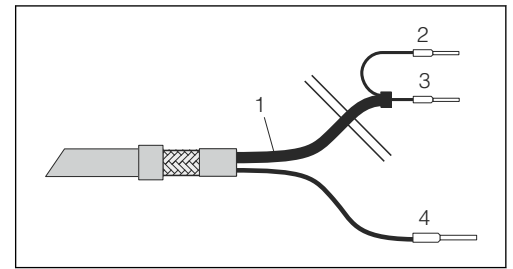

13 Cable CPK1: device connection

- 1 Coax cable
- 2 Inner shield BK (ref)
- 3 Inner coax (pH / mV)
- 4 Strand BN (PA)

2. Push the cable gland 5 and the washer 6 onto the coaxial cable.
3. Remove the insulation (13 mm (0.51")) and screw the clamping ring 7 onto the insulation.

i Parts 5 to 7 are supplied with the BNC connector for cable diameters 3.2 mm and 5 mm.

4. Fold the braided shield 8 of the shield over the clamping ring and cut off the excess material.
5. There is a semiconductor layer 14 (conductive membrane) between the inner insulation and the braided shield 8. Strip this semiconductor layer as far as the braided shield.

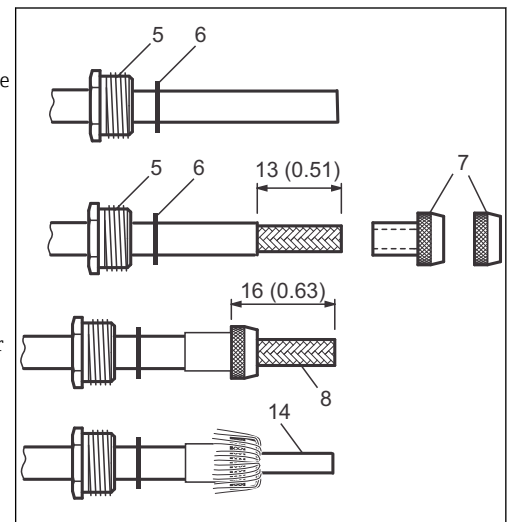

14 Terminating the pH connecting cable for mounting the BNC elbow plug. Dimensions in mm (inch)

6. Remove the inner insulation (4 mm (0.16")), fit end ferrule 13 on the stripped inner conductor and secure the end ferrule with a crimping pliers.

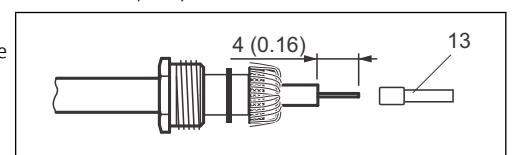

15 Terminating the pH connecting cable for mounting the BNC elbow plug. Dimensions in mm (inch)

7. Push the BNC connector housing 9 over the cable. The inner conductor must be located on the clamping surface 10 of the connector.
8. Tighten the cable gland 5.
9. Insert the clamp element 11 and screw in the connector cover 12. This creates a safe connection between the inner conductor and the connector pin.

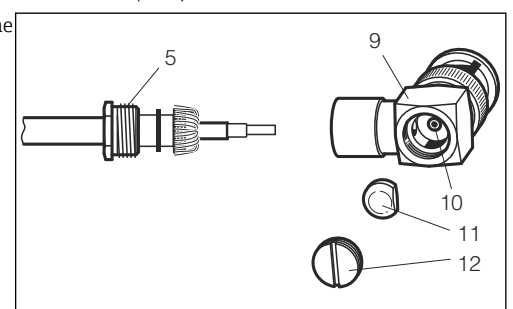

16 Mounting the pH connecting cable in the BNC elbow plug

Examples for connecting pH and ORP sensors

The following diagrams show the connection of various pH and ORP sensors.

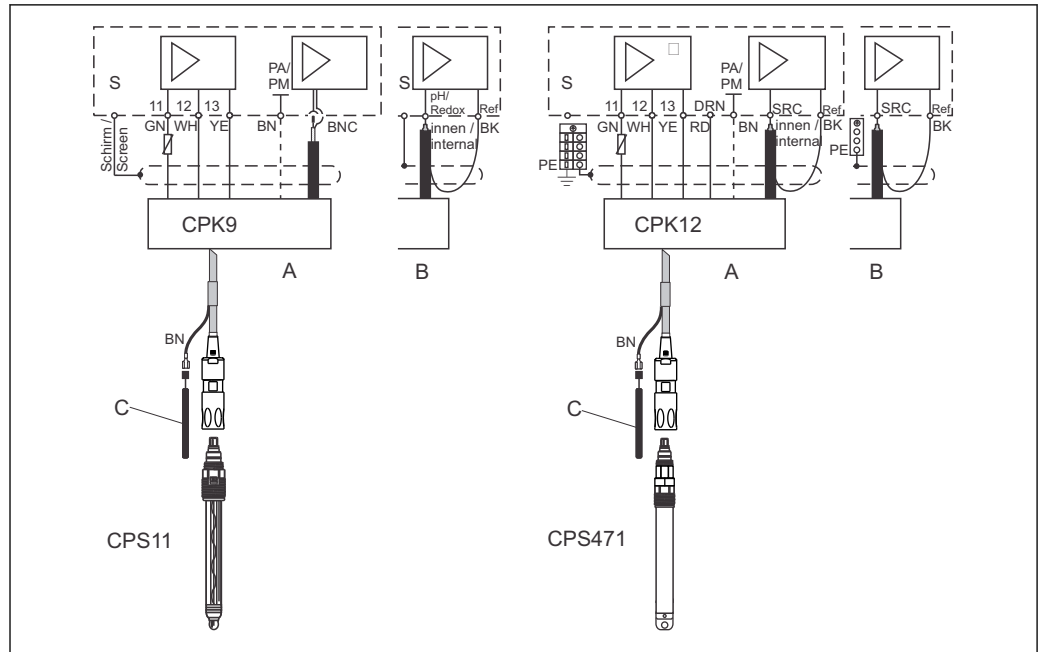

A0027565

17 Connecting glass electrode CPS11 with CPK9 (left) and ISFET sensor CPS471 with CPK12 (right) to Liquisys M

- A Panel-mounted device
- B Field device
- C Potential matching PM for symmetrical connection

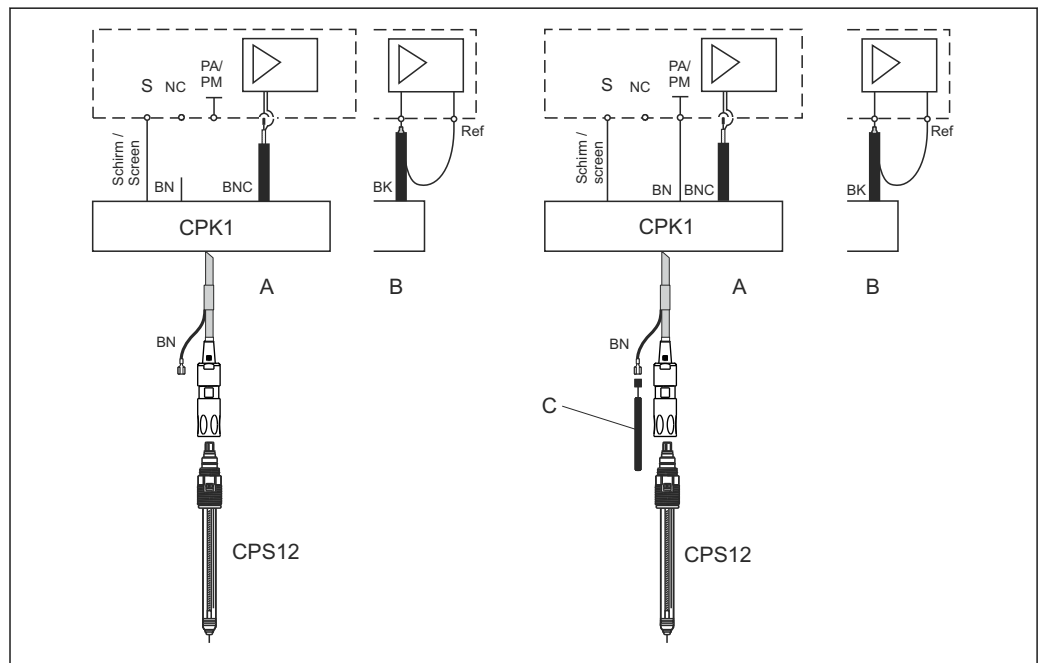

A0027566

18 Asymmetrical (without PML) and symmetrical (with PML) connection of ORP electrodes

- A Panel-mounted device
- B Field device
- C Potential matching (PM) in the medium for symmetrical connection

The pH and ORP sensors can be connected both symmetrically and asymmetrically. Generally, the following applies:

- No potential matching connection present: asymmetrical connection
- Potential matching connection present: symmetrical connection

The decision can also depend on the operating conditions.

Please note the following:

- Liquisys M is pre-programmed for symmetrical measurement with potential matching. If you want asymmetrical measurement, you have to change the configuration in the A2 field.
- If the "asymmetrical" software setting is selected for a symmetrical connection, the operating life of the reference electrode is reduced.

 In the case of a symmetrical connection, the potential matching pin must be connected and must always be immersed in the medium.

Advantages of symmetrical vs. asymmetrical:

- Symmetrical measurement:
 - No leak current since the reference and the pH/ORP electrode is connected with high impedance
 - Reliable measurement under difficult process conditions (strong flowing and high-impedance media, partially soiled diaphragm)
- Asymmetrical measurement:
 - Possible to use assemblies without potential matching

5.3 Electrical connection with Memosens functionality

5.3.1 Wiring diagram

The wiring diagram shows the connections of a device equipped with all the options. The connection of the sensors to the various measuring cables is explained in more detail in the "Measuring cables and sensor connection" section.

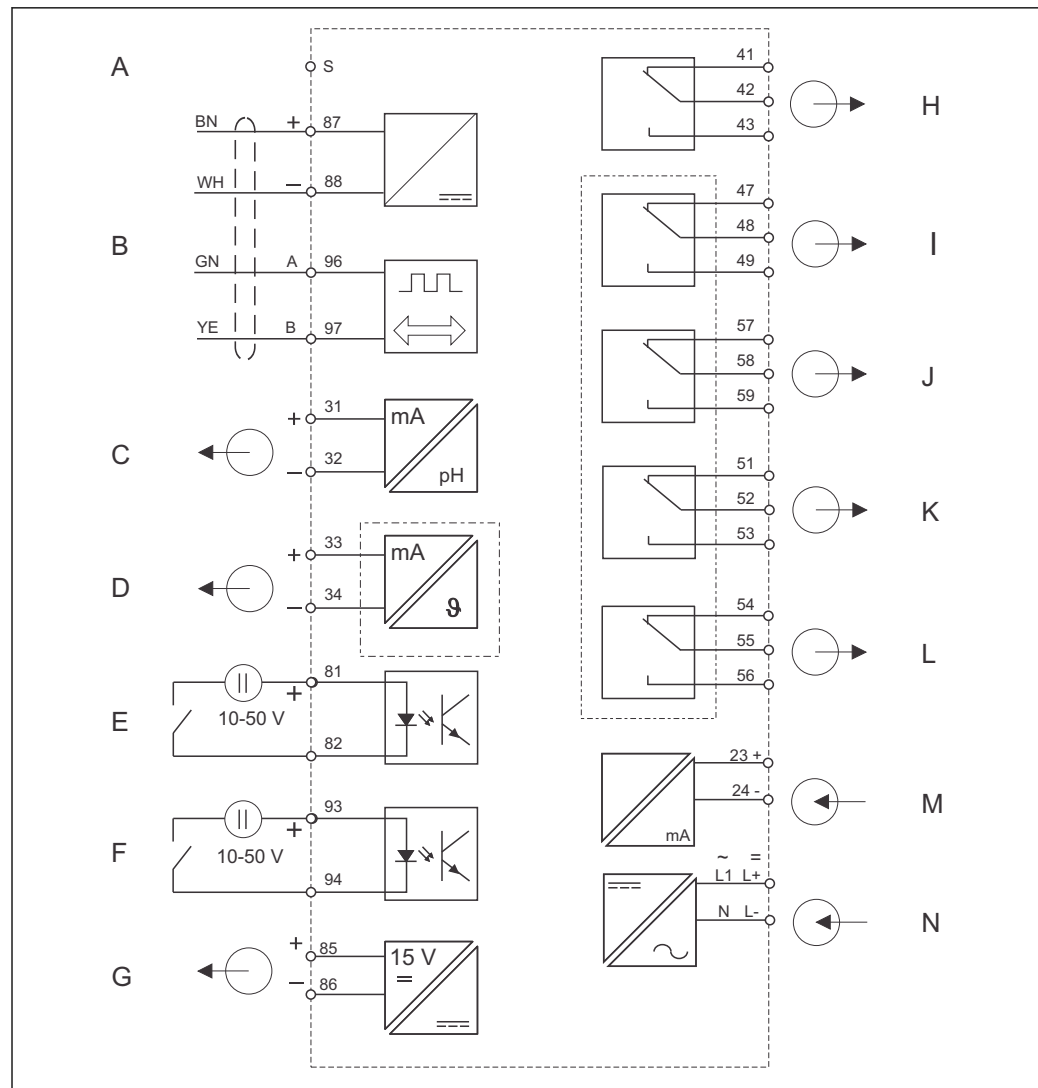

A0026028

19 Electrical connection of the transmitter with Memosens technology

- | | | | |
|---|---|---|---|
| A | Shielding | H | Alarm (current-free contact position) |
| B | Sensor | I | Relay 1 (current-free contact position) |
| C | Signal output 1 pH/ORP | J | Relay 2 (current-free contact position) |
| D | Signal output 2 temperature, pH/ORP or controller | K | Relay 3 (current-free contact position) |
| E | Binary input 1 (hold) | L | Relay 4 (current-free contact position) |
| F | Binary input 2 (Chemoclean) | M | Current input 4 to 20 mA |
| G | Auxiliary voltage output | N | Power connection |

i The device is approved for protection class II and is generally operated without a protective ground connection. Do not connect the sensor shielding to the transmitter.

Connecting a field device with Memosens functionality

Guide the measuring cables through the PG glands into the housing. Connect the measuring cables in accordance with the terminal assignment.

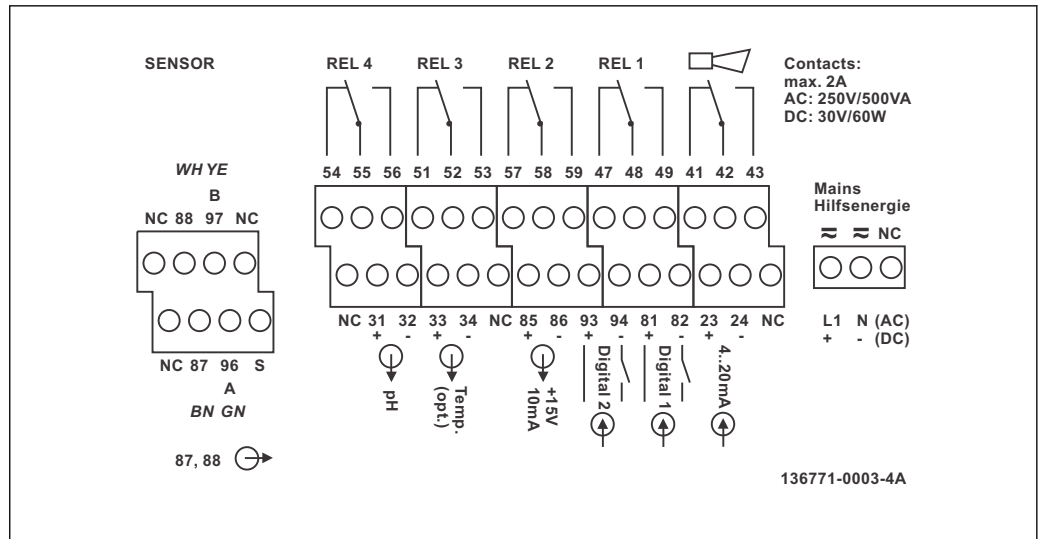

20 Connection compartment sticker of field device with Memosens functionality

NOTICE

Non-observance could cause incorrect measurement

- ▶ Terminals marked NC may not be connected.
- ▶ Unmarked terminals may not be connected.

Connecting a panel-mounted device with Memosens functionality

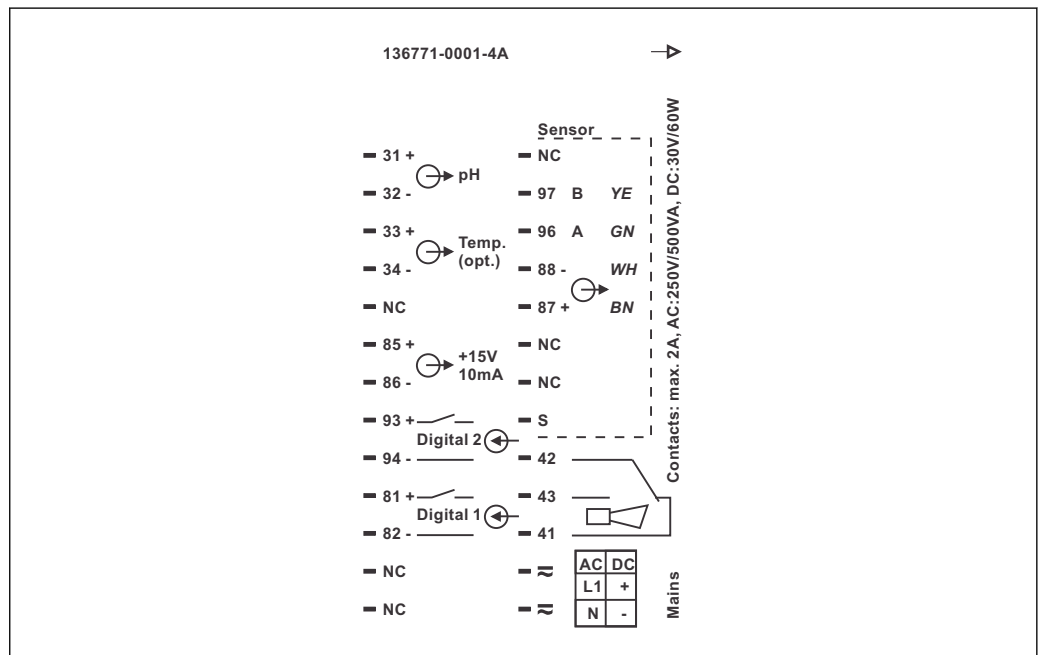

21 Connection sticker of panel-mounted device with Memosens functionality

NOTICE

Non-observance could cause incorrect measurement

- ▶ Terminals marked NC may not be connected.
- ▶ Unmarked terminals may not be connected.

- i** Please label the sensor terminal block with the TU sticker provided.
Do not use the pH sticker.

5.3.2 Measuring cables and sensor connection

To connect pH electrodes with Memosens functionality to the transmitter, you require the terminated data transmission cable CYK10 with 2x2 cores, twisted pair, shielding and PVC sheath.

Structure of the measuring cable

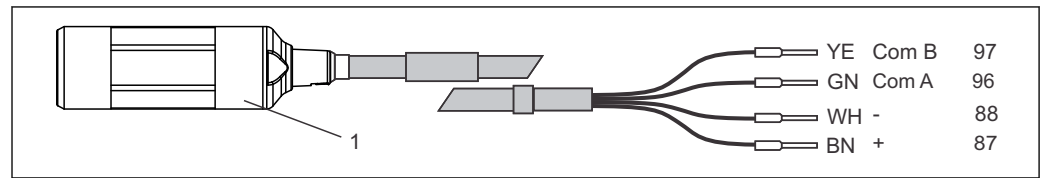

22 Structure of the CYK10 measuring cable

1 Coupling (to connect to the sensor) with integrated electronics

i For further information on the cable, please refer to the "Accessories" section.

Proceed as follows to attach the cable coupling to the sensor plug-in head:

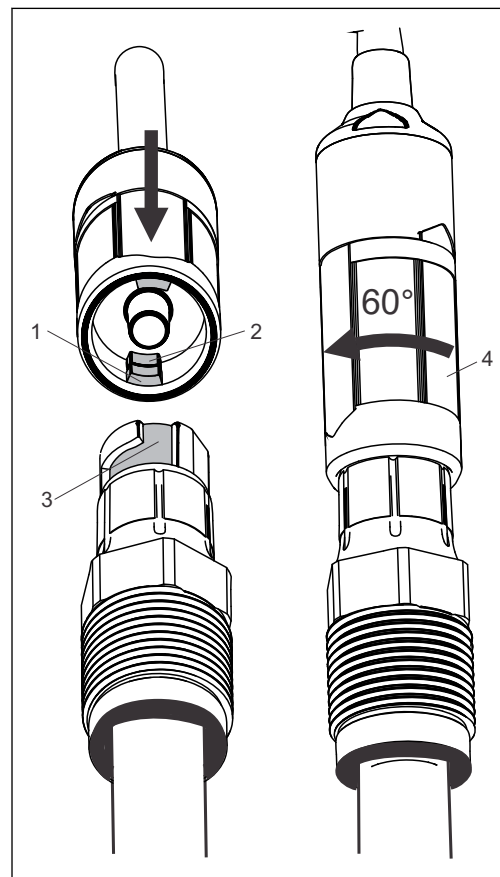

23 Handling the coupling

Field device measuring cable connection

Proceed as follows to connect a pH electrode to the field device:

1. Open the housing cover to access the terminal block in the connection compartment.
2. Break through the perforation for a cable gland, mount a Pg gland and guide the cable through this Pg gland.
3. Connect the cable in accordance with the terminal assignment.

4. Tighten the Pg gland.

Panel-mounted device measuring cable connection

To connect a pH electrode with Memosens functionality, connect the CYK10 cable in accordance with the terminal assignment to the terminals on the rear of the device (see connection sticker).

Example of connecting a pH electrode

The following diagram shows the connection of a pH electrode with Memosens functionality.

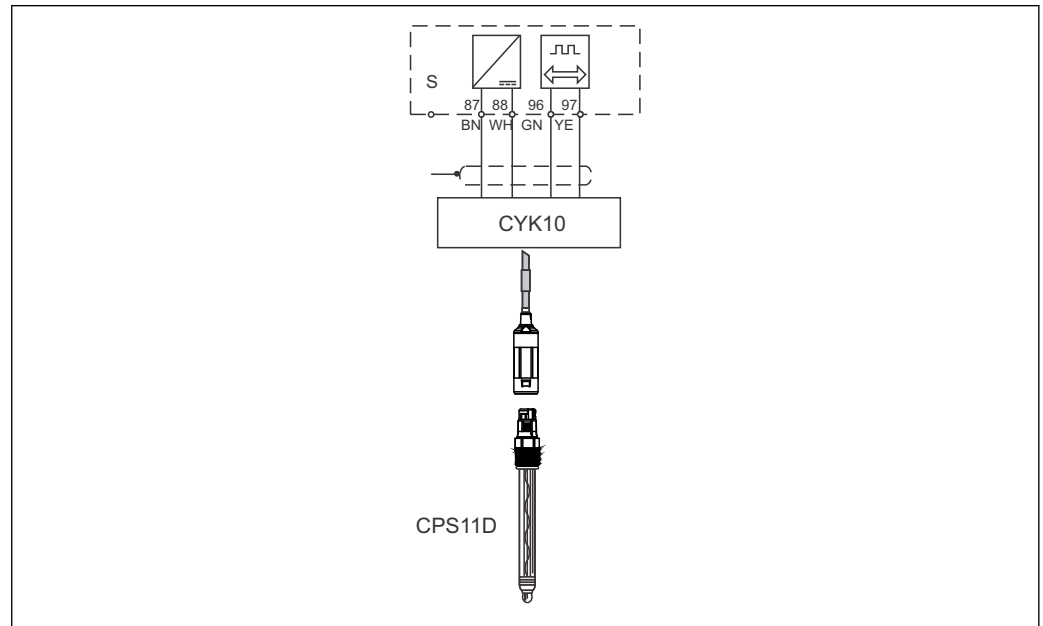

24 Connecting CPS11D with CYK10

A0026032

Signal transmission between the Memosens electrode and the coupling of the CYK10 cable is non-contact and takes place via completely potted coils. This offers the following advantages:

- As the electrode and transmitter are galvanically isolated, the signals are not affected by secondary potential. As a result, in contrast to sensors without Memosens functionality, a symmetrically high-impedance connection is not required to guarantee reliable measurement.
- The Memosens plug-in head and the Memosens coupling are completely water-proof.
- There are no open contacts. Contact corrosion, creepage currents and shunts are ruled out.

5.4 Alarm contact

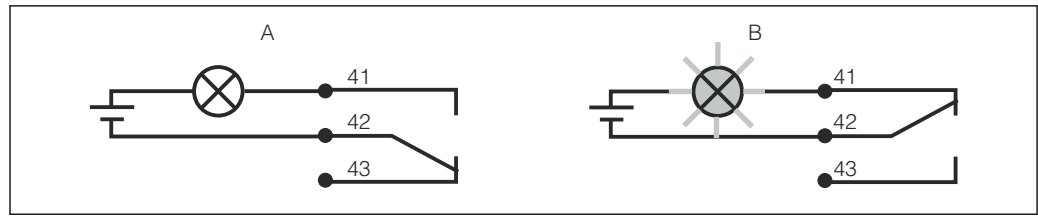

A0006415

25 Recommended fail-safe switching for the alarm contact

A Normal operating status
 B Alarm condition

Normal operating status

Device in operation and no error message present (alarm LED off):

- Relay energized
- Contact 42/43 closed

Alarm condition

Error message present (alarm LED red) or device defective or de-energized (alarm LED off):

- Relay de-energized
- Contact 41/42 closed

5.5 Post-connection check

Carry out the following checks once you have made the electrical connection:

Device state and specifications	Notes
Are the devices and cables free from damage on the outside?	Visual inspection

Electrical connection	Notes
Are the mounted cables strain relieved?	
Are the connected cables provided with strain relief?	
Is the cable run correct, without loops and cross-overs?	
Are the power cable and signal cables connected correctly and in accordance with the wiring diagram?	
Are all the screw terminals tightened?	
Are all the cable entries fitted, tightened and leak-proof?	
Are the PE distributor blocks grounded (if present)?	Grounding is carried out at the point of installation.

6 Operation options

6.1 Quick operation guide

You have the following ways of operating the transmitter:

- On site via the key field
- Via the HART interface (optional, with corresponding order version) with:
 - HART handheld terminal
 - PC with HART modem and the Fieldcare software package
- Via PROFIBUS PA/DP (optional, with corresponding order version) by PC with a corresponding interface and the Fieldcare software package or via a programmable logic controller (PLC).

 For operation via HART or PROFIBUS PA/DP, please read the relevant sections in the additional Operating Instructions:







- PROFIBUS PA/DP, field communication for Liquisys M CXM223/253, BA00209C/07/EN
- HART, field communication for Liquisys M CXM223/253, BA00208C/07/EN

The following section only explains operation via the keys.

6.2 Display and operating elements

6.2.1 Display

LED displays

  <small>A0027220</small>	Indicates the current operating mode, "Auto" (green LED) or "Manual" (yellow LED)
 1  2 <small>A0027222</small>	Indicates the activated relay in the "Manual" mode (red LED) The status of relays 3 and 4 is indicated on the LC display.
 REL 1  REL 2 <small>A0027221</small>	Indicates the working status of relay 1 and 2 LED green: measured value within the permitted limit, relay inactive LED red: measured value outside the permitted limit, relay active
 ALARM <small>A0027218</small>	Alarm display, e.g. in event of continuous limit value overshoot, temperature sensor failure or system error (see error list)

LC display

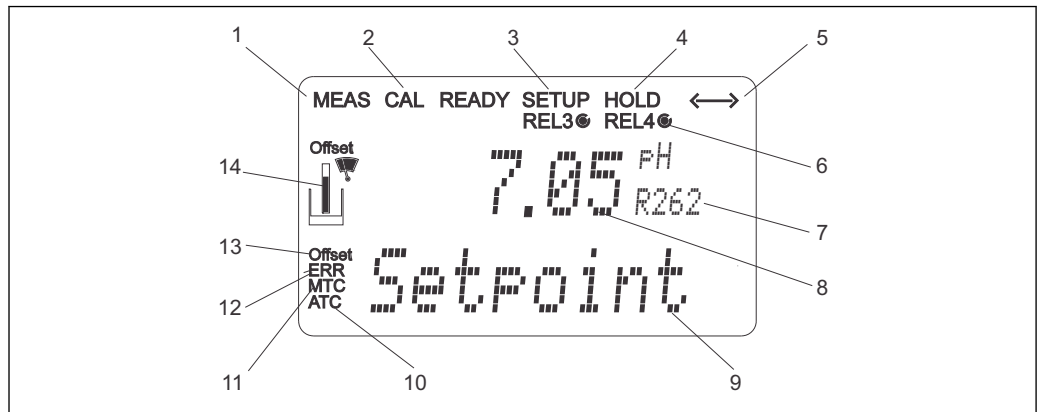

A0027223-EN

26 Transmitter LC display

- 1 Indicator for measuring mode (normal operation)
- 2 Indicator for calibration mode
- 3 Indicator for setup mode (configuration)
- 4 Indicator for "Hold" mode (current outputs remain at last current state)
- 5 Indicator for receipt of a message on devices with communication
- 6 Indicator of working status of relays 3/4: ○ inactive, ● active
- 7 Function code
- 8 In measuring mode: measured variable - in setup mode: configured variable
- 9 In measuring mode: secondary measured value - in setup/calibr. mode: e.g. set value
- 10 Indicator for autom. Temperature compensation
- 11 Indicator for man. Temperature compensation
- 12 "Error": error display
- 13 Temperature offset
- 14 Sensor symbol (see the "Calibration" section)

6.2.2 Operating elements

The display shows the current measured value and the temperature simultaneously, which means you have an overview of the most important process data at once. Help text in the configuration menu helps users configure the device parameters.

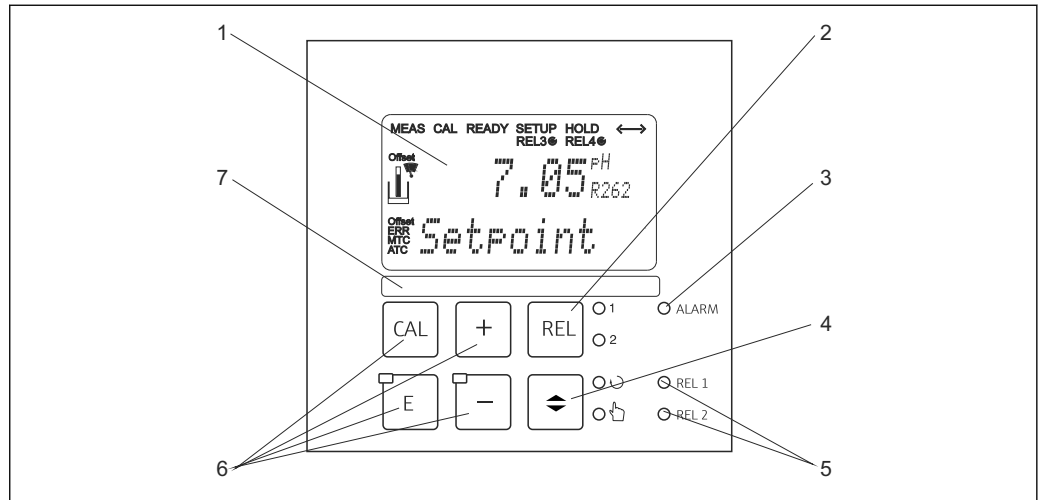







A0024629-EN

27 Operating elements

- 1 LC display for displaying the measured values and configuration data
- 2 Key to switch relays in manual mode and to display the active contact
- 3 LED for alarm function
- 4 Changeover switch for automatic/manual mode
- 5 LEDs for limit contactor relay (switch status)
- 6 Main operating keys for calibration and device configuration
- 7 Field for user-defined information

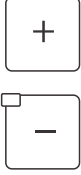
6.2.3 Key functions

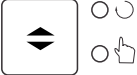
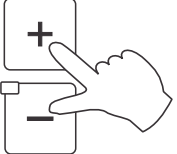
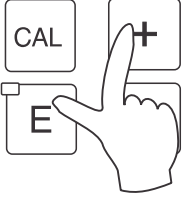
 <p style="text-align: right; font-size: small;">A0027235</p>	<p>CAL key</p> <p>When you press the CAL key, the device first prompts you for the calibration access code:</p> <ul style="list-style-type: none"> ■ Code 22 for calibration ■ Code 0 or any other code for reading the last calibration data <p>Use the CAL key to accept the calibration data or to switch from field to field within the calibration menu.</p>
 <p style="text-align: right; font-size: small;">A0027236</p>	<p>ENTER key</p> <p>When you press the ENTER key, the device first prompts you for the setup mode access code:</p> <ul style="list-style-type: none"> ■ Code 22 for setup and configuration ■ Code 0 or any other code for reading all the configuration data. <p>The ENTER key has several functions:</p> <ul style="list-style-type: none"> ■ Calls up the Setup menu from the measuring mode ■ Saves (confirms) data entered in the setup mode ■ Moves on within function groups



 <p style="text-align: right; font-size: small;">A0027240</p>	<p>PLUS key and MINUS key</p> <p>In the Setup mode, the PLUS and MINUS keys have the following functions:</p> <ul style="list-style-type: none"> ■ Selection of function groups. Press the MINUS key to select the function groups in the order given in the "System configuration" section. ■ Configuration of parameters and numerical values ■ Operation of the relays in manual mode <p>In the measuring mode, the following sequence of functions is accessed by repeatedly pressing the PLUS key:</p> <ul style="list-style-type: none"> ■ Temperature displayed in °F ■ Temperature is hidden ■ Measured value display in mV ■ Current input signal in % ■ Current input signal in mA ■ Return to basic settings <p>In the measuring mode, the following sequence of information is displayed by repeatedly pressing the MINUS key:</p> <ul style="list-style-type: none"> ■ The current errors are displayed consecutively (max. 10). ■ Once all the errors have been displayed, the standard measurement display appears. In the function group F, an alarm can be defined separately for each error code.
 <p style="text-align: right; font-size: small;">A0027241</p>	<p>REL key</p> <p>In the manual mode, you can use the REL key to switch between the relay and the manual start of cleaning.</p> <p>In automatic mode, you can use the REL key to read out the switch-on points (for limit contactor) or set points (for PID controller) assigned to the relay in question.</p> <p>Press the PLUS key to jump to the settings of the next relay. Use the REL key to get back to the display mode (automatic return after 30 s).</p>
 <p style="text-align: right; font-size: small;">A0027234</p>	<p>AUTO key</p> <p>Use the AUTO key to switch between automatic mode and manual mode.</p>
 <p style="text-align: right; font-size: small;">A0027237</p>	<p>Escape function</p> <p>If you press the PLUS and MINUS key simultaneously, you return to the main menu, or are taken to the end of calibration if calibrating.</p> <p>If you press the PLUS and MINUS key again, you return to the measuring mode.</p>
 <p style="text-align: right; font-size: small;">A0027238</p>	<p>Locking the keyboard</p> <p>Press the PLUS and ENTER key simultaneously for at least 3 s to lock the keyboard against any unauthorized data entry. All the settings can continue to be read.</p> <p>The code prompt displays the code 9999.</p>
 <p style="text-align: right; font-size: small;">A0027239</p>	<p>Unlocking the keyboard</p> <p>Press the CAL and MINUS key simultaneously for at least 3 s to unlock the keyboard.</p> <p>The code prompt displays the code 0.</p>

6.3 Local operation

6.3.1 Automatic/manual mode

The transmitter normally operates in automatic mode. Here, the relays are triggered by the transmitter. In the manual mode, you can trigger the relays manually using the REL key or start the cleaning function.

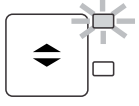
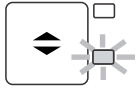
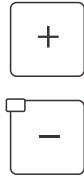
How to change the operating mode:

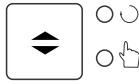
 <p>A0027242</p>	1.	The transmitter is in automatic mode. The top LED (green) next to the AUTO key is lit.
 <p>A0027243</p>	2.	Press the AUTOMATIC key.
 <p>A0027240</p>	3.	To enable the manual mode, enter the code 22 via the PLUS and MINUS keys and press ENTER to confirm. The lower LED (manual mode) is lit.
 <p>A0027241</p>	4.	Select the relay or the function. You can use the REL key to switch between the relays. The relay selected and the switch status (ON/OFF) is displayed on the second line of the display. In the manual mode, the measured value is displayed continuously (e.g. for measured value monitoring for dosing functions).
 <p>A0027240</p>	5.	Switch the relay. The relay is switched on with PLUS and switched off with MINUS. The relay remains in this switched state until it is switched again.
 <p>A0027234</p>	6.	Press the AUTOMATIC key to return to the measuring mode, i.e. to the automatic mode. All the relays are triggered again by the transmitter.

-  The operating mode remains in effect even after a power failure. The relays assume the quiescent state, however.
- The manual mode has priority over all other automatic functions.
- Hardware locking is not possible in the manual mode.
- The manual settings are kept until they are actively reset.
- Error code E102 is signaled during manual operation.

6.3.2 Operating concept

Operating modes

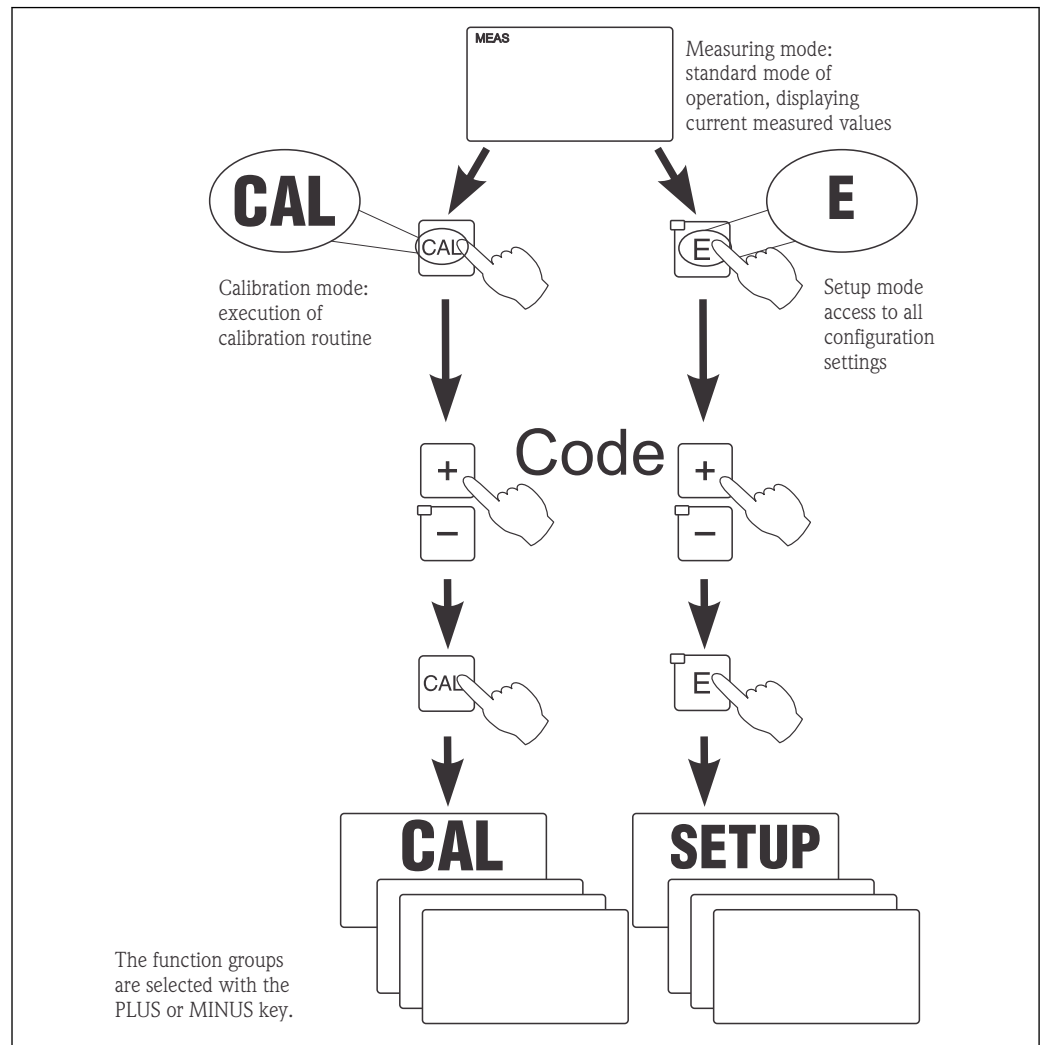

A0027244-EN

28 Description of the possible operating modes

i If no key is pressed in the setup mode for approx. 15 min, the device automatically returns to the measuring mode. Any active hold (hold during setup) is canceled.

Access codes

All device access codes are fixed and cannot be altered. When the device requests the access code, it distinguishes between different codes.

- **CAL key + code 22:** access to Calibration and Offset menu
- **ENTER key + code 22:** access to the menus for the parameters which make configuration and user-specific settings possible
- **PLUS + ENTER keys** simultaneously (min. 3 s): lock the keyboard
- **CAL + MINUS keys** simultaneously (min. 3 s): unlock the keyboard
- **CAL or ENTER key + any code:** access to read mode, i.e. all the settings can be read but not modified.

The device continues measuring in the read mode. It does not shift to the "Hold" status. The current output and the controllers remain active.

Menu structure

The configuration and calibration functions are arranged in function groups.

- In the setup mode, select a function group with the PLUS and MINUS keys.
- In the function group itself, switch from function to function with the ENTER key.
- Within the function, select the desired option with the PLUS and MINUS keys or edit the settings with these keys. Then confirm with the ENTER key and continue.
- Press the PLUS and MINUS keys simultaneously (Escape function) to exit programming (return to the main menu).
- Press the PLUS and MINUS keys simultaneously again to switch to the measuring mode.

 If a modified setting is not confirmed by pressing ENTER, the old setting is retained.
An overview of the menu structure is provided in the Appendix to these Operating Instructions.

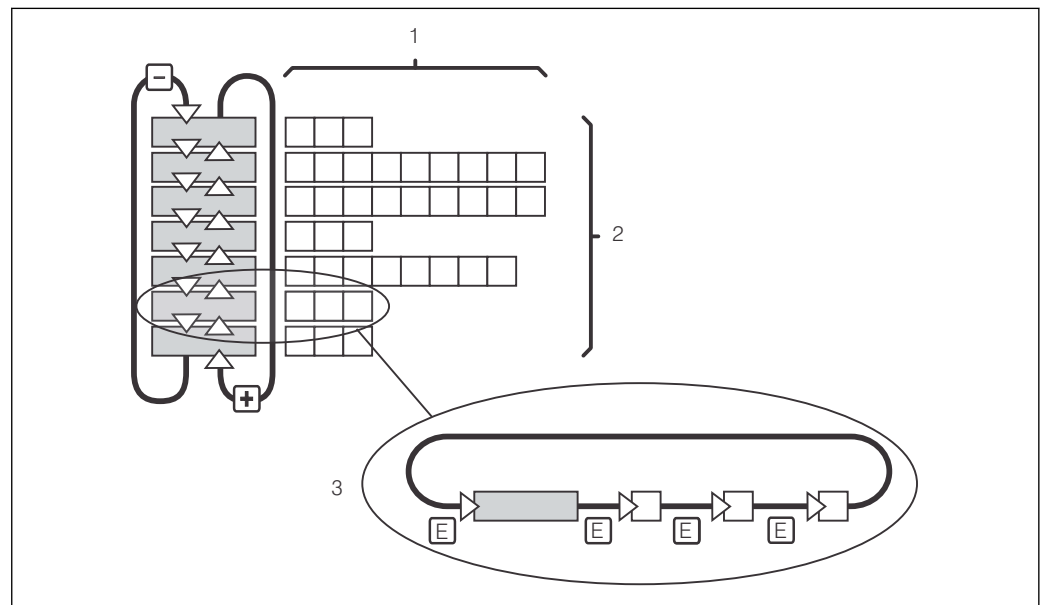

 29 Menu structure

- 1 Functions (selection of parameters, entry of numbers)
- 2 Function groups, scroll backwards and forwards with the PLUS and MINUS keys
- 3 Switch from function to function with the ENTER key

Hold function: "freeze" the outputs

In both the setup mode and during calibration, the current output can be "frozen" (factory setting), i.e. it constantly retains its current status. "HOLD" appears on the display. If the controller actuating variable (steady control 4 to 20 mA) is output via current output 2, it is set to 0/4 mA during a hold.

- Hold settings can be found in the "Service" function group.
- During a hold, all contacts assume a quiescent state.
- An active hold has priority over all other automatic functions.
- With every hold, the I-component of the controller is set to "0".
- Any alarm delay is reset to "0".
- This function can also be activated externally via the hold input (see Wiring diagram; binary input 1).
- A manual hold (field S3) remains active even after a power failure.

7 Commissioning

7.1 Specificities of commissioning digital electrodes

pH sensors with Memosens technology save the calibration data. For this reason, commissioning these sensors is different to commissioning standard electrodes.

To do this, proceed as follows:

1. Install the transmitter and the assembly.
2. Connect the transmitter and the sensor cable.
3. Configure the transmitter for your specific requirements (see the "Device configuration" section).
4. Connect the sensor with Memosens technology, which was precalibrated at the factory, and immerse it into the medium or the buffer.
5. The saved sensor-specific calibration data are automatically transmitted to the transmitter.
6. The measured value is displayed. Normally, you can accept this value without calibrating the sensor.
 - ↳ Calibration is only required in the following cases:
 - When very strict accuracy requirements apply
 - When the sensor has been in storage for longer than 3 months
7. Check the transfer of the measured value to the process control system or the evaluation unit.

7.2 Specificities of commissioning ISFET sensors

Switch-on behavior

A closed-control loop is created when the measuring system is switched on. The measured value adjusts to the real value during this time (approx. 5 to 8 minutes). This settling behavior occurs every time the liquid film between the pH-sensitive semiconductor and the reference lead is interrupted (e.g. caused by dry storage or intensive cleaning with compressed air). The settling time depends on the length of the interruption.

Sensitivity to light

Like all semiconductor components, the ISFET chip is sensitive to light (measured value variations). However, this only affects the measured value if the sensor is directly exposed to sunlight. For this reason, avoid direct sunlight when calibrating. Normal ambient light does not have any effect on the measurement.

7.3 Function check

WARNING

Incorrect connection, incorrect supply voltage

Safety risks for staff and device malfunctions

- ▶ Check that all connections have been established correctly in accordance with the wiring diagram.
- ▶ Ensure that the supply voltage matches the voltage indicated on the nameplate.

7.4 Switching on

Familiarize yourself with the operation of the transmitter before it is first switched on. In particular please read the "Basic safety instructions" and "Operation options" sections. After power-up, the device performs a self-test and then goes to the measuring mode.

Now calibrate the sensor in accordance with the instructions in the "Calibration" section.

i During initial commissioning, the sensor must be calibrated so that the measuring system can return precise measurement data (does not apply for digital sensors).

Then perform the first configuration in accordance with the instructions in the "Quick setup" section. The values set by the user are kept even in the event of a power failure.

The following function groups are available in the transmitter (the groups that are only available in the Plus Package are marked accordingly in the functional description):

Setup mode

- SETUP 1 (A)
- SETUP 2 (B)
- CURRENT INPUT (Z)
- CURRENT OUTPUT (O)
- ALARM (F)
- CHECK (P)
- RELAY (R)
- SERVICE (S)
- E+H SERVICE (E)
- INTERFACE (I)

Calibration and offset mode

- CALIBRATION (C)
- NUMERIC (N)
- OFFSET (V)

i A detailed explanation of the function groups available in the transmitter can be found in the "Device configuration" section.

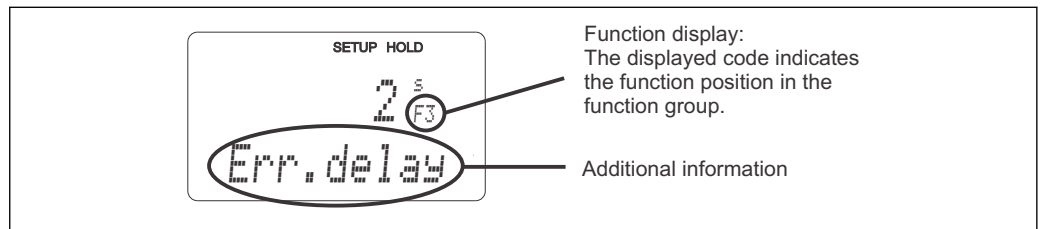

A0025560-EN

30 Information for the user on the display

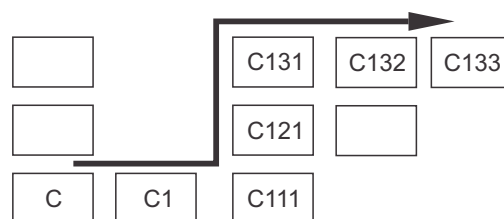

To make it easier for you to select and find function groups and functions, a code for the corresponding field is displayed for each function → **30**. The structure of this code is illustrated in → **31**. The function groups are indicated as letters in the first column (see the names of the function groups). The functions of the individual groups are displayed incrementally by row and by column.

A0027502

31 Function code

Factory settings

The first time the device is switched on, the factory setting is set for all the functions. The table below provides an overview of the most important settings.

All other factory settings can be found in the description of the individual function groups in the "System configuration" section (the factory setting is highlighted in **bold**).



Function	Factory setting
Type of measurement	pH or ORP absolute, Temperature measurement in °C
Type of temperature compensation	Linear with reference temperature 25 °C
Temperature compensation	Automatic (ATC on)
Limit value for controller 1	pH 16 (ORP: -1500 mV or 0 %)
Limit value for controller 2	pH 16 (ORP: +1500 mV or 100 %)
Hold	Active during configuration and calibration
Contact 1 to 4	Limit contactor pH, function off
Current outputs 1* and 2*	4 to 20 mA
Current output 1: measured value for 4 mA signal current*	pH 2
Current output 1: measured value for 20 mA signal current*	pH 12
Current output 2: temperature value for 4 mA signal current*	0.0 °C
Current output 2: temperature value for 20 mA signal current*	100.0 °C

* with appropriate version

7.5 Quick Setup

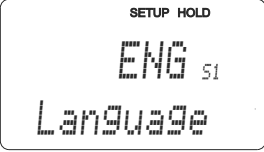
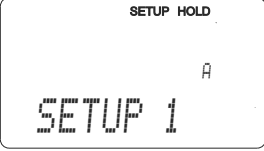
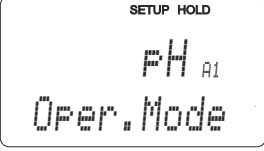
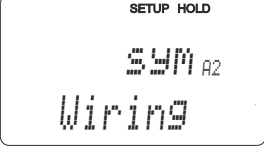
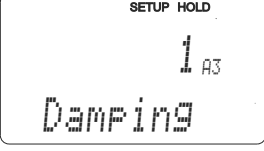
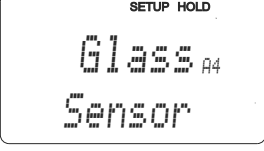
After power-up, you must make some settings to configure the most important functions of the transmitter which are required for correct measurement. The following section gives an example of this.

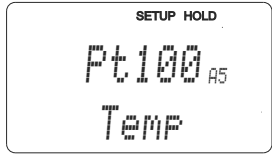
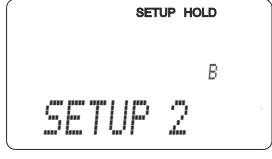
User entry		Range of adjustment (factory settings in bold)	Display
1.	Press the ENTER key		
2.	Enter the code 22 to open access to the menus. Press the ENTER key.		
3.	Press the MINUS key until you get to the "Service" function group.		
4.	Press ENTER to be able to make your settings.		A0008408-EN
5.	Select your language in S1, e.g. "ENG" for English. Press ENTER to confirm your entry.	ENG = English GER = German FRA = French ITA = Italian NEL = Dutch ESP = Spanish	
6.	Press the PLUS and MINUS key simultaneously to exit the "Service" function group.		A0008409-EN
7.	Press the MINUS key until you get to the "Setup 1" function group.		
8.	Press ENTER to be able to make your settings for "Setup 1".		
9.	In A1, select the desired mode of operation, e.g. "pH". Press ENTER to confirm your entry.	pH ORP (= redox) mV ORP (= redox) %	
10.	In A2, select the type of connection for your sensor. Also refer to the "Sensor connection" section for this. Press ENTER to confirm your entry.	sym = symmetrical asym = asymmetrical	
11.	In A3, enter the damping factor. Measured value damping averages the individual measured values and serves to stabilize the display and the signal output. Enter "1" if no measured value damping is required. Press ENTER to confirm your entry.	1 1 to 60	
12.	In A4, specify the type of sensor that you are using, e.g. "Glass" for glass electrode. Press ENTER to confirm your entry.	Glass ISFET	
			A0007828-EN

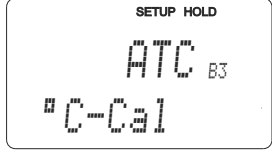
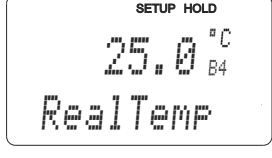
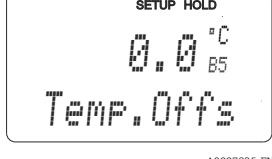
User entry		Range of adjustment (factory settings in bold)	Display
13.	In A5, select the temperature sensor that the electrode being used has, e.g. "Pt 100" for a glass electrode. Press ENTER to confirm your entry. The display returns to the initial display of the "Setup 1" function group.	Pt 100 Pt 1K NTC 30K None	 <p>SETUP HOLD Pt100_{A5} Temp</p> <p>A0007829-EN</p>
14.	Press the MINUS key until you get to the "Setup 2" function group. Press ENTER to make your settings for "Setup 2".		 <p>SETUP HOLD B SETUP 2</p> <p>A0009009-EN</p>
15.	In B1, select the type of temperature compensation for the process, e.g. ATC for automatic temperature compensation. Press ENTER to confirm your entry. If you have chosen ATC, the menu automatically skips to field B3.	ATC MTC	 <p>SETUP HOLD ATC_{B1} "C-Process</p> <p>A0007831-EN</p>
16.	In B3, select the type of temperature compensation for the calibration, e.g. ATC for automatic temperature compensation. Press ENTER to confirm your entry.	ATC MTC	 <p>SETUP HOLD ATC_{B3} "C-Cal</p> <p>A0007833-EN</p>
17.	The current temperature is displayed in B4. If necessary, adjust the temperature sensor to an external measurement. Press ENTER to confirm your entry.	Actual value displayed and entered -50.0 to 150.0 °C	 <p>SETUP HOLD 25.0 °C_{B4} RealTemp</p> <p>A0007834-EN</p>
18.	The difference between the measured and entered temperature is displayed. Press the ENTER key The display returns to the initial display of the "Setup 2" function group.	0.0 °C -5.0 to 5.0 °C	 <p>SETUP HOLD 0.0 °C_{B5} Temp. Offs</p> <p>A0007835-EN</p>
19.	Press PLUS and MINUS simultaneously to switch to the measurement mode.		





7.6 Device configuration

7.6.1 Setup 1 (pH/ORP)

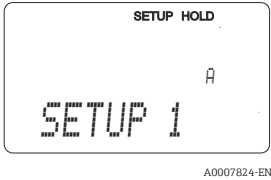
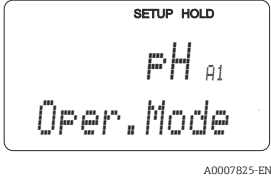

In the SETUP 1 function group, you can change the settings for the measuring mode and the sensor. All the settings in this menu are made during initial commissioning. However, you can change the settings at any time.

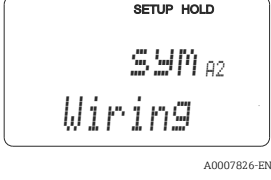
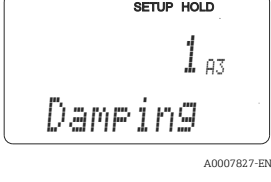
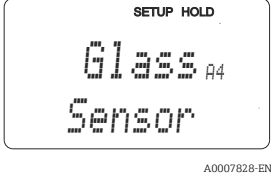
 An error message (E010) is output if the temperature sensor is defective. Measuring continues at a process temperature of 25 °C.

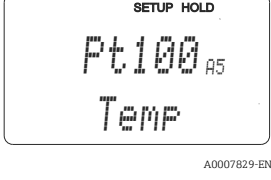
Setup 1 for ISFET and standard sensors

Coding	Field	Range of adjustment (factory settings in bold)	Display	Info
A	SETUP 1 function group		 A0007824-EN	Configuration of basic functions
A1	Select the operating mode auswählen	pH ORP (= redox) mV ORP (= redox) %	 A0007825-EN	 When the operating mode is changed, all user settings are automatically reset.
A2	Select the type of connection	sym = symmetrical asym = asymmetrical	 A0007826-EN	Detailed information on symmetrical or asymmetrical connections can be found in the "Sensor connection" section.
A3	Enter the value for measured value damping	1 1 to 60	 A0007827-EN	Measured value damping causes averaging over the specified number of individual measured values. This is used, for example, to stabilize the display if the measurement is unstable. There is no damping if "1" is entered.
A4	Select the sensor	Glass Antimony ISFET	 A0007828-EN	For glass electrodes: glass For ISFET sensors: ISFET  Glass electrodes may only be used with zero point pH 7.
A5	Select the temperature sensor	Pt 100 Pt 1K NTC 30K None	 A0007829-EN	Selection field only available for "IS" version. For ISFET sensors: select Pt 1K (Pt 1000) For glass electrodes: select Pt 100 No temperature sensor available: select MTC in B1 field!

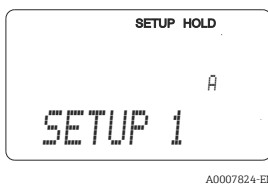
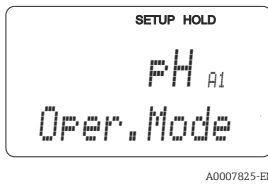
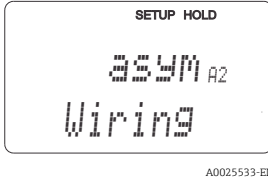
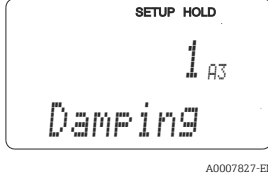
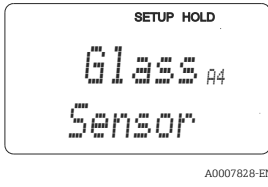
Setup 1 for digital sensors

Coding	Field	Range of adjustment (factory settings in bold)	Display	Info
A	SETUP 1 function group		 A0007824-EN	Configuration of basic functions
A1	Select the operating mode	pH	 A0007825-EN	No edit option
A2	Type of connection	asym = asymmetrical	 A0025533-EN	No edit option Thanks to the non-contact, galvanically isolated signal transmission, only simple asymmetrical connection is necessary.
A3	Enter the value for measured value damping	1 1 to 60	 A0007827-EN	Measured value damping causes averaging over the specified number of individual measured values. This is used, for example, to stabilize the display if the measurement is unstable. There is no damping if "1" is entered.
A4	Sensor	Glass	 A0007828-EN	No edit option  Glass electrodes may only be used with zero point pH 7.

7.6.2 Setup 2 (temperature)

Use this function group to change the settings for temperature measurement.

You already made all the settings for this function group during initial commissioning. However, you can change the values chosen at any time.

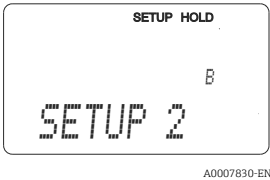
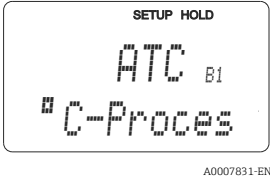
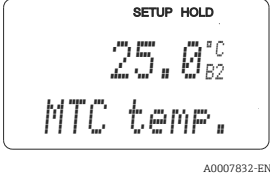
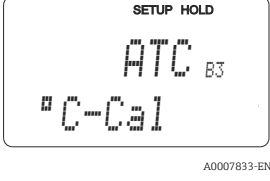
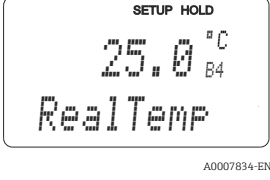
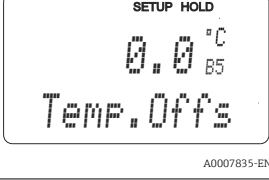
Coding	Field	Range of adjustment (factory settings in bold)	Display	Info
B	SETUP 2 function group			Settings for temperature measurement
B1	pH: Type of temperature compensation for the process ORP: Temperature measurement	<ul style="list-style-type: none"> For pH operating mode: ATC MTC For ORP operating mode: Off On 		If B1 = ATC: jump to B3 If B1 = MTC: in B2, enter the process temperature which is to be used for compensation.
B2	Enter the process temperature	25.0 °C -50.0 to 150.0 °C		Only if A1 = pH and B1 = MTC You can edit the displayed value. The value entered can only be in °C.
B3	Type of temperature compensation for the calibration	ATC MTC		If B1 = ATC: editing is possible. If B1 = MTC: read only B3 = MTC, return to B. A separate temperature sensor must also be immersed in the buffer solution.
B4	Enter the temperature	25.0 °C -50.0 to 150.0 °C		Only if B1 = ATC You can edit the displayed value. The value entered can only be in °C.
B5	Temperature difference (offset) is displayed	0.0 °C -5.0 to 5.0 °C		Only if B1 = ATC The difference between the measured and entered temperature is displayed.

7.6.3 Current input

For the "Current input" function group, you require a relay card with a current input which is not available in the basic device version. With this function group, you can monitor process parameters and use them for feedforward control. For this purpose, you must

connect the current output of an external measured variable (e.g. flowmeter) to the 4 to 20mA input of the transmitter. The following assignment applies:

Flow in main stream	Current signal in mA	Current input signal in %
Flowmeter start of measuring range	4	0
Flowmeter end of measuring range	20	100

Flow monitoring in the main stream

This arrangement is particularly practical if the sample flow through a flow assembly in an open outlet is independent of the flow in the main stream.

This permits signaling of an alarm condition in the main stream (flow too low or has completely stopped) and triggers dosing switch-off even if the medium flow is maintained due to the method of installation.

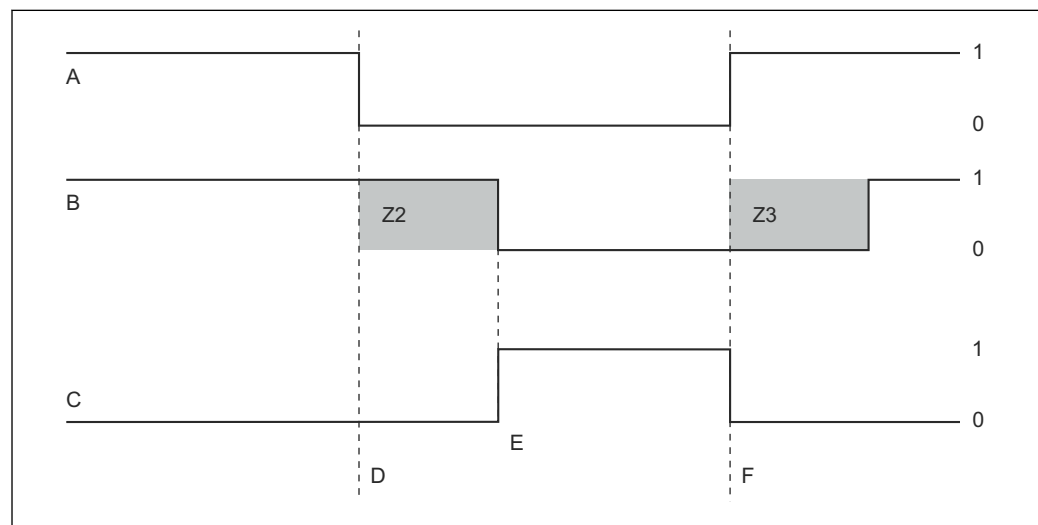

A0008923

32 Alarm signaling and dosing switch-off by the main stream

- | | | | |
|---|---|----|---|
| A | Flow in main stream | F | Flow restoration |
| B | Relay contacts of PID controller | Z2 | Delay for controller switch-off, see field Z2 |
| C | Alarm relay | Z3 | Delay for controller switch-on, see field Z3 |
| D | Flow below switch-off limit Z 4 or flow failure | 0 | Off |
| E | Flow alarm | 1 | On |

Feedforward control to PID controller

You can optimize control on control systems with very short response times by measuring the medium flow rate in addition to the oxygen content. Then apply this flow rate value (4 to 20 mA) as feedforward control to the PID controller.

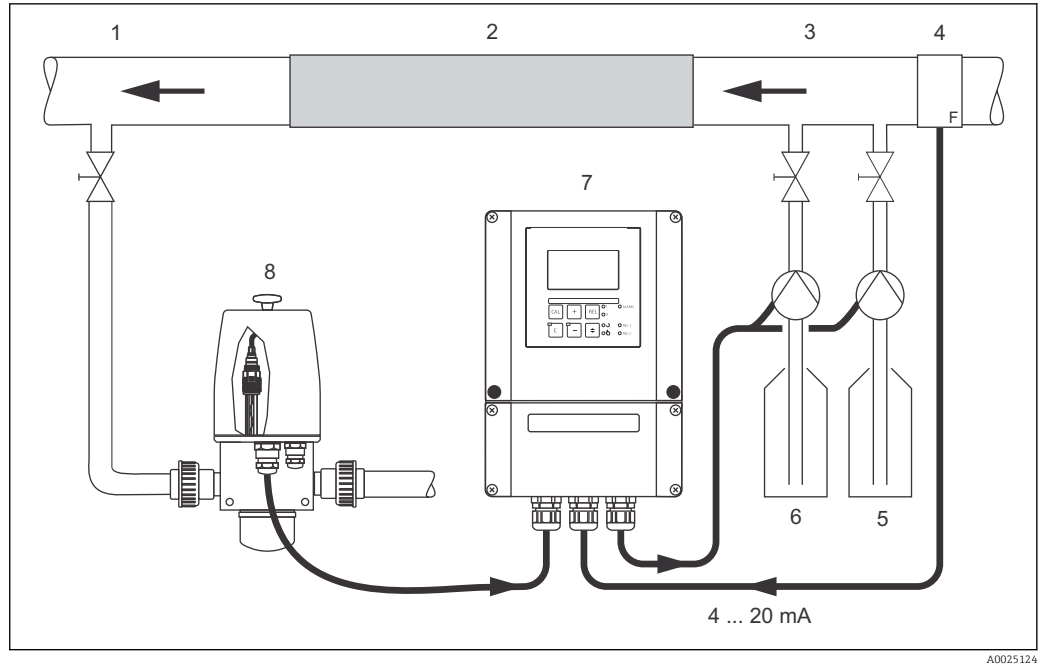

33 Sample arrangement for feedforward control of the flow in the main stream to the PID controller

- | | | | |
|---|----------------------|---|-------------------|
| 1 | Medium tapping point | 5 | Base |
| 2 | Static mixer | 6 | Acid |
| 3 | Injection points | 7 | Liquisys CPM253 |
| 4 | Flowmeter | 8 | CPA250 with CPS11 |

Feedforward control is a multiplying function as illustrated in the figure below (example with factory setting):

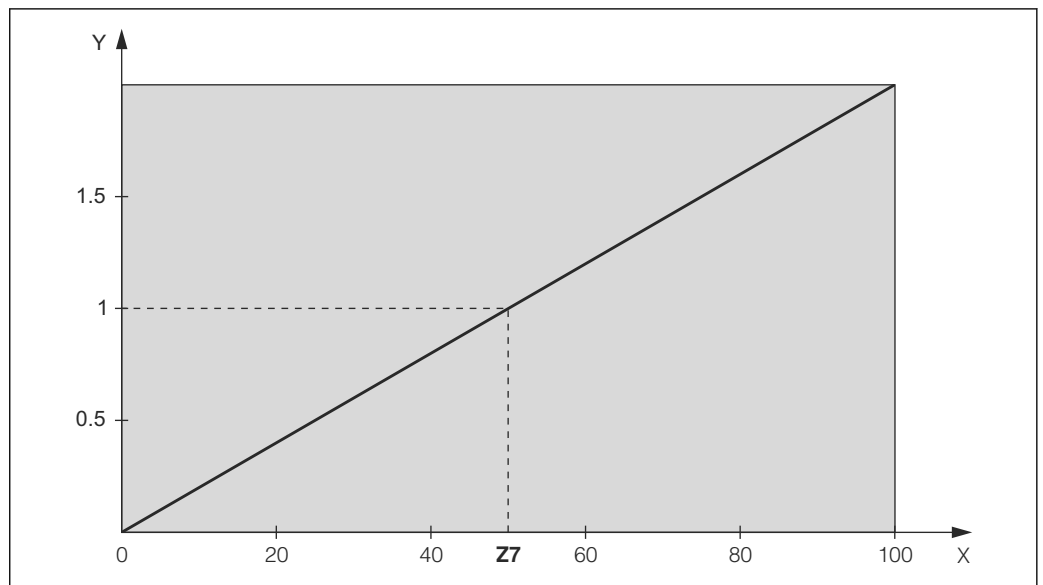

34 Multiplying feedforward control

- Y Gain K_{infl}
 X Current input signal in [%]

Functions marked in italics are not supported by the basic device version.

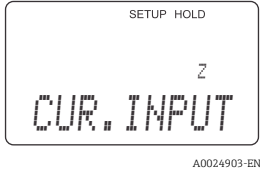
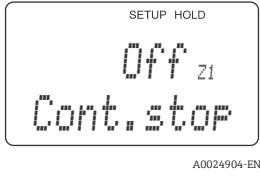
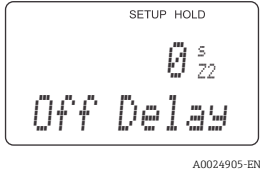
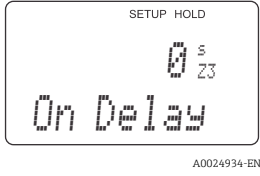
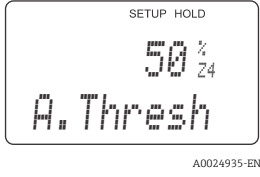
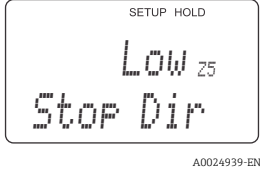
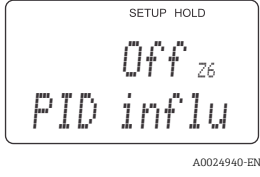
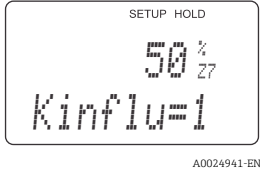
Coding	Field	Range of adjustment (factory settings in bold)	Display	Info
Z	CURRENT INPUT function group			Current input settings
Z1	Select flow monitoring of main stream (with controller switch-off)	Off On		Flow monitoring may only be switched on if the flowmeter is connected in the main stream. If Z1 = off, fields Z2 to Z5 are not available.
Z2	Enter the delay for controller switch-off through current input	0 s 0 to 2000 s		Brief flow shortfalls can be suppressed by this delay and do not result in controller switch-off.
Z3	Enter the delay for controller switch-on through current input	0 s 0 to 2000 s		In the case of a controller, a delay until the reception of a representative measured value is recommended after a long period without flow.
Z4	Enter the switch-off limit value for the current input	50 % 0 to 100 %		0 to 100% corresponds to 4 to 20 mA at the current input. Observe measured value assignment to the current output of the flowmeter.
Z5	Enter the switch-off direction for the current input	Low High		The controller is switched off if the value entered in Z4 is undershot or overshoot.
Z6	Select feedforward control to PID controller	Off Lin = linear Basic		If Z6 = off, the field Z7 is not available. Z6 = basic: disturbance variable only affects the basic load (alternatively dosing in proportion to quantity, if usual PID controller not possible, e.g. defective sensor).
Z7	Enter value for feedforward control at which gain = 1 applies	50 % 0 to 100 %		When the value is set, the controller actuating variable is the same size when feedforward control is switched on as when feedforward control is switched off.

7.6.4 Current outputs

Use the "Current output" function group to configure the individual outputs. You can enter either a linear characteristic (O3 (1)) or a user-defined current output characteristic in conjunction with the Plus Package (O3 (3)). Exception: if you have chosen a "continuous controller" for current output 2, you cannot enter a user-defined current output characteristic for this current output.

In addition, you can also simulate a current output value (O3 (2)) to check the current outputs.

If a second current output is present, you can output the controller actuating variable via the current output in accordance with field R237/R266.

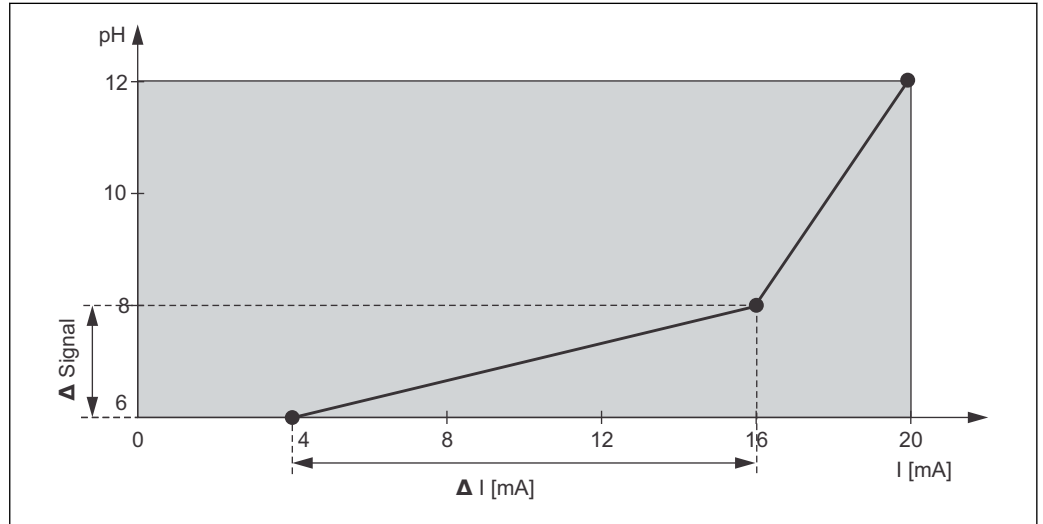

A0025023

35 User-defined current output characteristic (example)

The current output characteristic must increase or decrease very monotonically.

The distance per mA between two table value pairs must be greater than:

- pH: 0.03
- ORP: 5 mV
- Temperature 0.25 °C

The values for the sample characteristic → 35 are entered in the following table. The distance per mA is calculated from $\Delta \text{ signal} / \Delta \text{ mA}$.

Value pair	Current output 1			Current output 2		
	[mS/cm] [%] [°C]	Current [mA]	Distance per mA	[mS/cm] [%] [°C]	Current [mA]	Distance per mA
1	500	4				
2	1000	16	41.66			
3	2000	20	250			

First enter the desired current output configuration into the following blank table with a pencil. Calculate the resulting signal distance per mA to observe the necessary minimum slope. Then enter the values in the device.

Value pair	Current output 1			Current output 2		
	[pH; mV; %; °C]	Current [mA]	Distance per mA	[pH; mV; %; °C]	Current [mA]	Distance per mA
1						
2						
3						
4						
5						
6						
7						
8						
9						
10						

Functions marked in *italics* are not supported by the basic device version.

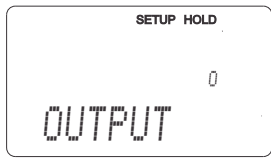
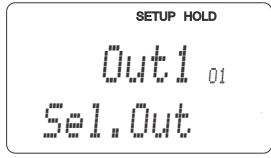
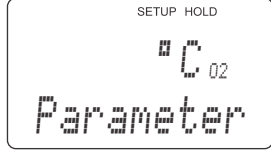
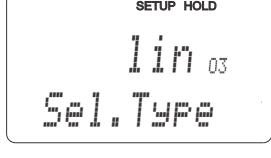
Coding	Field	Range of adjustment (factory settings in bold)	Display	Info
0	CURRENT OUTPUT function group		 A0025026-EN	Configuration of the current output (does not apply for PROFIBUS).
01	Select current output	Out 1 <i>Out 2</i>	 A0025027-EN	A characteristic can be selected for every output.
02	Select measured variable for 2nd current output	°C <i>pH, mV</i> <i>Contr</i>	 A0025028-EN	R237/R266=curr (current output 2) can only be selected if O2=Contr (controller) is selected (relay card required).
03 (1)	Enter the characteristic type	Lin = linear (1) <i>Sim = simulation (2)</i> <i>Tab = table (3)</i>	 A0025029-EN	The characteristic can have a positive or negative slope for the measured value output. In the case of actuating variable output (O2 = Contr), an increasing current corresponds to an increasing actuating variable.

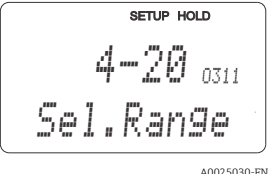
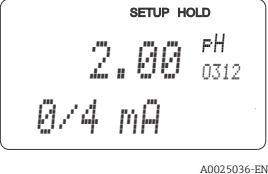
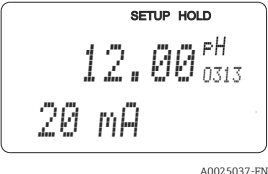
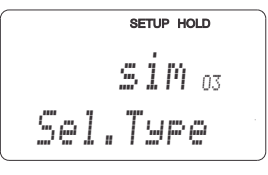
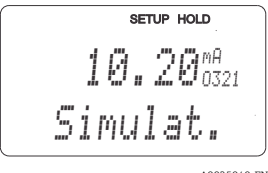
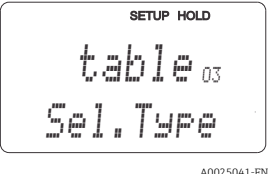
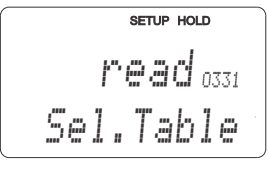
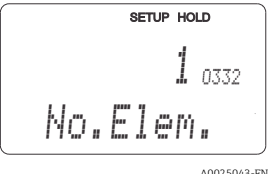
Coding	Field	Range of adjustment (factory settings in bold)	Display	Info
0311	Select current range	4 to 20mA 0 to 20 mA		
0312	0/4 mA value: Enter the associated measured value	pH 2.00 pH -2.00 to 16.00 -1500 mV -1500 to 1500 mV 0.0 % 0.0 to 100.0 % 0.0 °C -20.0 to 150.0 °C		Here you can enter the measured value at which the min. current value (0/4 mA) is applied at the transmitter output (not for controller). (Turndown see Technical data.)
0313	20 mA value: Enter the associated measured value	pH 12.00 pH -2.00 to 16.00 1500 mV -1500 to 1500 mV 100.0 % 0.0 to 100.0 % 100.0 °C -20.0 to 150.0 °C		Here you can enter the measured value at which the max. current value (20 mA) is applied at the transmitter output (not for controller). (Turndown see Technical data.)
03 (2)	Simulate current output	Lin = linear (1) Sim = simulation (2) Tab = table (3)		Simulation is not ended until 03(1) or 03(3) is selected. For further characteristics, see 03 (1), 03 (3).
0321	Enter simulation value	Current value 0.00 to 22.00 mA		Entering a current value results in this value being directly output at the current output.
03 (3)	Enter current output table	Lin = linear (1) Sim = simulation (2) Tab = table (3)		Only for Plus Package Values can also be subsequently added or modified. The values entered are automatically sorted by increasing current value. For further characteristics, see 03 (1), 03 (2).
0331	Select table option	Read Edit		
0332	Enter number of table value pairs	1 1 to 10		Enter the number of pairs of x and y values (measured value and current value) here.

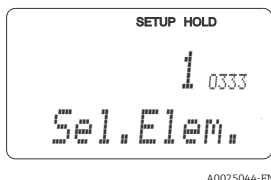
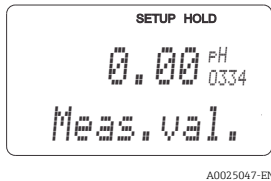
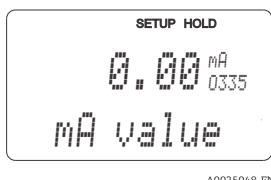
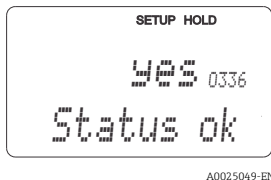
Coding	Field	Range of adjustment (factory settings in bold)	Display	Info
0333	Select table value pair	1 1 to no. elem. Assign	 <p>A0025044-EN</p>	The system runs through the 0333 to 0335 function chain as often as indicated in 0332. "Assign" appears as the last step. The display goes to 0336 after confirmation.
0334	Enter x value	pH 2.00 pH -2.00 to 16.00 -1500 mV -1500 to 1500 mV 0.0 % 0.0 to 100.0 % 0.0 °C -20.0 to 150.0 °C	 <p>A0025047-EN</p>	x value = measured value specified by user.
0335	Enter y value	0.00 mA 0.00 to 20.00 mA	 <p>A0025048-EN</p>	y value = user-defined current value pertaining to 0334. Return to 0333 until all values are entered.
0336	Message as to whether table status is OK	Yes No	 <p>A0025049-EN</p>	Back to 03. If status = no, correct the table (all settings made up until now remain intact) or go back to the measuring mode (table is deleted).

7.6.5 Alarm



You can use the "Alarm" function group to define various alarms and configure output contacts.

Each individual error can be defined to be effective or not (at the contact or as an error current).

Moreover, the electrode can be checked for glass breakage and leak current (P1, P2, P7).

In the event of an alarm, a cleaning function can also be activated (F8).

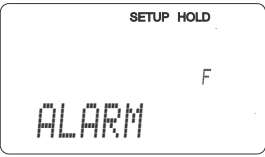
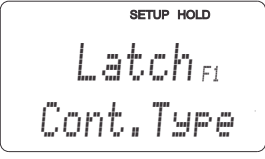
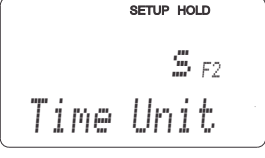
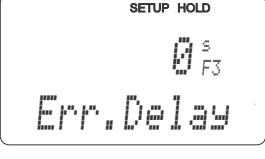
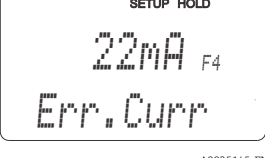
Functions marked in italics are not supported by the basic device version.

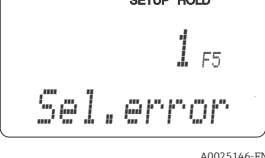
Coding	Field	Range of adjustment (factory settings in bold)	Display	Info
F	ALARM function group			Alarm function settings.
F1	Select contact type	Latch = latching contact Momen = momentary contact		The option selected only applies for the fault-signaling contact, not for the error current.
F2	Select the time unit for the alarm delay	s min		
F3	Enter alarm delay	0 s (min) 0 to 2000 s (min)		Depending on the option selected in F2, the alarm delay can be entered in s or min.
F4	Select error current	22 mA 2.4 mA		 If "0-20 mA" was selected in O311, "2.4 mA" may not be used.
F5	Select the error number	1 1 to 255		Here you can select all the errors which should trigger an alarm. The errors are selected by the error numbers. Please refer to the table in the "System error messages" section for the meaning of the individual error numbers. The factory settings remain in effect for all errors that are not edited.

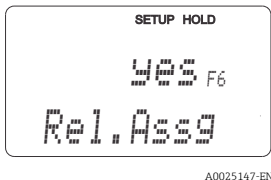
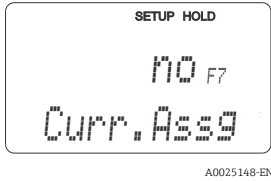
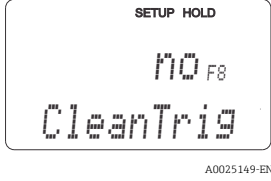
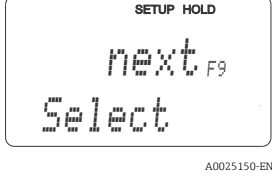
Coding	Field	Range of adjustment (factory settings in bold)	Display	Info
F6	Set alarm contact to be effective for the selected error	Yes No	 <p>A0025147-EN</p>	If "no" is selected, all the other alarm settings are deactivated (e.g. alarm delay). The settings themselves are maintained. This setting only applies to the error currently selected in F5.
F7	Set error current to be effective for the selected error	No Yes	 <p>A0025148-EN</p>	The option selected in F4 is effective or not effective in the event of an error. This setting only applies to the error currently selected in F5.
F8	<i>Automatic cleaning function start</i>	No Yes	 <p>A0025149-EN</p>	This field is not available for certain errors, see the "Troubleshooting and fault elimination" section.
F9	Select return to menu or next error	Next = next error number ←R	 <p>A0025150-EN</p>	If ←R is selected, you return to F. If Next is selected, you go to F5.

7.6.6 Check

The CHECK function group is only available for devices with a Plus Package.

In the CHECK function group, you can select different monitoring functions for the measurement.

SCS electrode monitoring

The Sensor Check System monitors the pH and reference electrode for incorrect measurement and complete failure.

SCS identifies the following reasons for incorrect measurement:

- Electrode glass breakage
- Fine short circuits in the pH measuring circuit, also e.g. moisture or dirt bridges at terminal points
- Contamination or clogging of the reference electrode
- Leak current for ISFET sensor

The following three monitoring methods are used:

- Monitoring the high impedance of the pH electrode (alarm if a minimum impedance is undershot, approx. 500 kΩ).
This function cannot be selected for antimony and ISFET electrodes.
- Monitoring the impedance of the reference electrode (alarm if set threshold value overshot).
This function can only be selected for symmetrically high-impedance measurement.
- Monitoring of leak current for ISFET sensors (pre-alert E168 at $I_{LEAK} > 200$ nA, error E008 at $I_{LEAK} > 400$ nA).

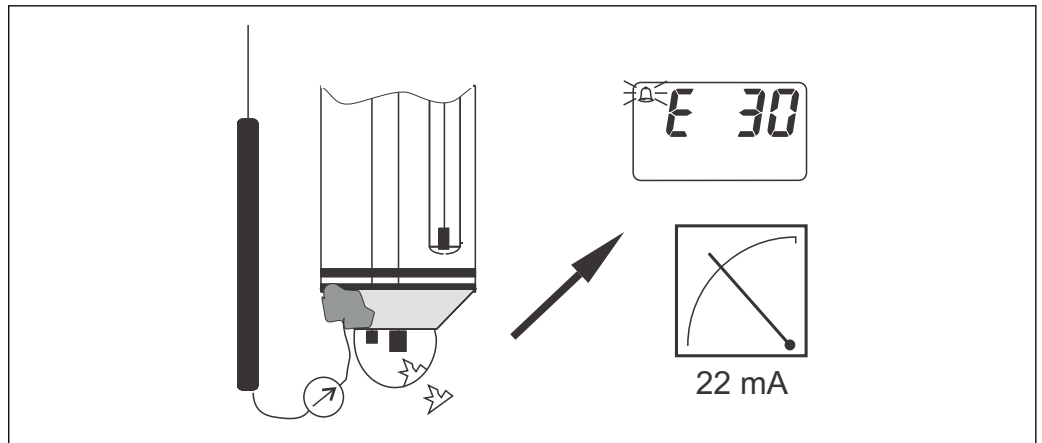

A0025195

36 SCS alarm

i Do not remove the standard electrode from the process without a hold! Since SCS is measured against the PML, no contact between the inner conductor and PML triggers an alarm. In digital sensors, SCS is not measured against the PML.

PCS alarm (process check system)

The AC function is used to check measuring signals for deviations. If the measuring signal change within an hour is smaller than 0.5% (of full scale value of the selected measuring range), an alarm (E152) is triggered. The reason for such sensor behavior can be contamination, cable open circuit or similar.

You can monitor the controller activity with the CC function. A malfunction of the controller is detected and reported thanks to freely adjustable monitoring times (E154 to E157).

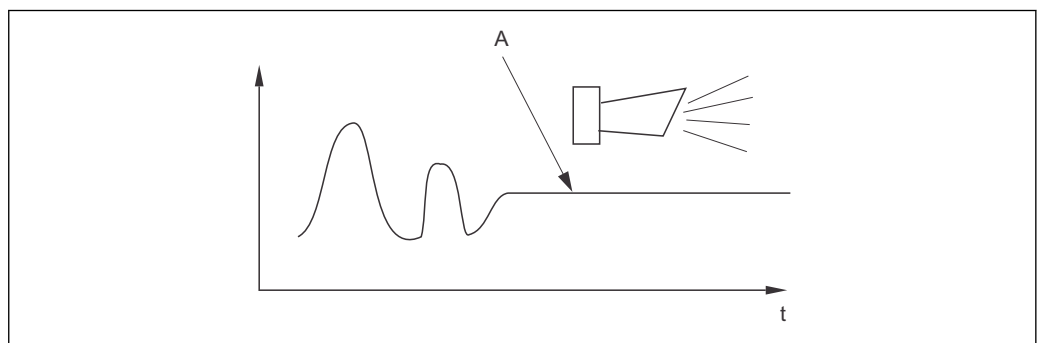

A0025196

37 PCS alarm (live check)

A Constant measuring signal = alarm triggered after PCS alarm time has elapsed

Please note the following:

- The electrode must be symmetrically connected (with PML) to monitor the reference.
- Any PCS alarm pending is automatically deleted as soon as the sensor signal changes.
- Due to its semiconductor component, the ISFET sensor is sensitive to light and reacts with measured value fluctuations. For this reason, avoid direct sunlight when calibrating and operating. Normal ambient light does not have any effect on the measurement.

Alarm threshold monitoring

You can use this function to monitor the measured value for permissible upper and lower limits and trigger an alarm.

Operating voltage SCS for pH sensors with Memosens functionality

If the connection between the pH sensor with Memosens functionality and cable is just connected but not locked, the supply voltage can drop below the required voltage value due to the poor coupling. This results in incorrect measurement.

With the operating voltage SCS, the supply voltage of a pH sensor with Memosens functionality is monitored.

If this value drops below the safety limit, the measured value is ignored and the error E127 is output.

You can use the "Check" function group to monitor the measured value for permissible upper and lower limits and trigger an alarm.

Functions marked in italics are not supported by the basic device version.

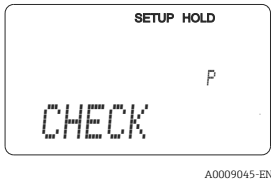
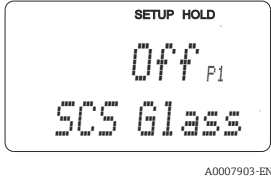
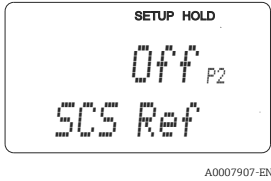
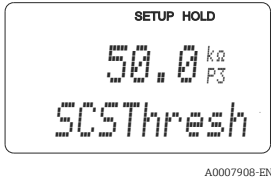
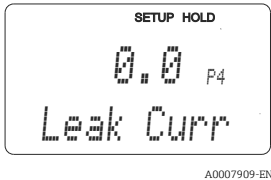
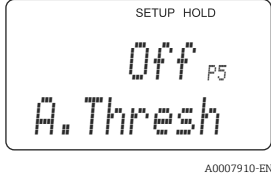
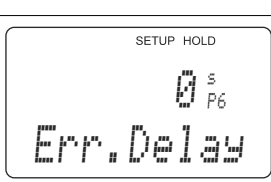
Coding	Field	Range of adjustment (factory settings in bold)	Display	Info
P	CHECK function group		 A0009045-EN	Settings for electrode and process monitoring
P1	<i>Switch SCS alarm for the measuring electrode on or off</i>	Off On	 A0007903-EN	Monitoring of electrode for glass breakage (error no.: E008). Response time approx. 30 s SCS glass warning (error no.: E175) SCS monitoring is not active during calibration.
P2	<i>Switch SCS alarm for the reference electrode on or off</i>	Off On	 A0007907-EN	Monitoring of reference electrode for contamination or clogging (error no.: E030). Response time approx. 60 s SCS ref warning (error no.: E177) Only if A2=sym.
P3	<i>Enter SCS alarm threshold for reference electrode</i>	50.0 kΩ 0.0 to 50 kΩ	 A0007908-EN	The measurement result also contains the resistance of the medium. The impedance of the reference electrode increases with the degree of contamination. Not for Memosens
P4	<i>Leak current display for ISFET sensor</i>	Read only! 0.0 to 9.9 μA	 A0007909-EN	Only if A4= ISFET. Leak currents > 0.4 μA indicate damage to the ISFET sensor.
P5	<i>Select alarm threshold monitoring</i>	Off Low High LoHi = low and high Lo! Hi! LoHi!	 A0007910-EN	Alarm possible with or without controller switch-off. xxxx = without controller switch-off xxxx! = with controller switch-off
P6	<i>Enter alarm delay</i>	0 s (min) 0 to 2000 s (min)	 A0007911-EN	Depending on the option selected in F2, the alarm delay can be entered in min or s. This time must first elapse before undershooting/overshooting in accordance with field P7/P8 results in an alarm.

Coding	Field	Range of adjustment (factory settings in bold)	Display	Info
P7	Enter lower alarm threshold	-2.00 pH -2.00 to 16.00 pH		Not applicable when P5 = off.
P8	Enter upper alarm threshold	16.00 pH -2.00 to 16.00 pH		Not applicable when P5 = off.
P9	Select process monitoring (PCS alarm)	Off AC CC ACCC AC! CC! ACCC!		AC = sensor activity monitoring CC = controller monitoring Alarm possible with or without simultaneous controller switch-off. xxxx = without controller switch-off xxxx! = with controller switch-off
P10	Enter maximum permissible duration for alarm threshold undershoot	60 min 0 to 2000 min		Only if P9=CC or AC CC.
P11	Enter maximum permissible duration for alarm threshold overshoot	120 min 0 to 2000 min		Only if P9=CC or AC CC.
P12	Enter alarm threshold (for P10/P11)	1.00 pH -2.00 to 16.00 pH		Set value is an absolute value. This function is primarily suited to batch operation and single-sided limit switches.

7.6.7 Relay configuration

For the "RELAY" function group, you require a relay card which is not available in the basic device version.

The following relay contacts can be selected and configured as desired (max. four contacts, depending on options installed):

- Limit contactor for pH / ORP: R2 (1)
- Limit contactor for temperature: R2 (2)
- PID controller: R2 (3)
- Timer for cleaning function: R2 (4)
- Chemoclean function: R2 (5)
- Neutralization controller: R2 (6) (for Plus Package)

Limit contactor for pH/ORP measured value and temperature

The transmitter has different ways of assigning a relay contact. Switch-on and switch-off points and pickup and dropout delays can be assigned to the limit contactor. In addition, you can configure an alarm threshold to output an error message and to start a cleaning function in conjunction with this.

These functions can be used both for the primary value and for temperature measurement.

Please refer to the switch states in →  38 for a clear illustration of the relay contact states.

- When the measured values increase (maximum function), the relay contact is closed as of t_2 after the switch-on point (t_1) has been exceeded and the pickup delay has elapsed ($t_2 - t_1$).
The alarm contact switches if the alarm threshold (t_3) is reached and the alarm delay ($t_4 - t_3$) has also elapsed (errors E067 to E070).
- When the measured values decrease, the alarm contact is reset when the value falls below the alarm threshold (t_5) again, as is the relay contact (t_7) after the dropout delay ($t_7 - t_6$).
- If the pickup and dropout delays are set to 0 s, the switch-on and switch-off points are also switch points of the contacts.

The same settings can also be made for a minimum function in the same way as for the maximum function.

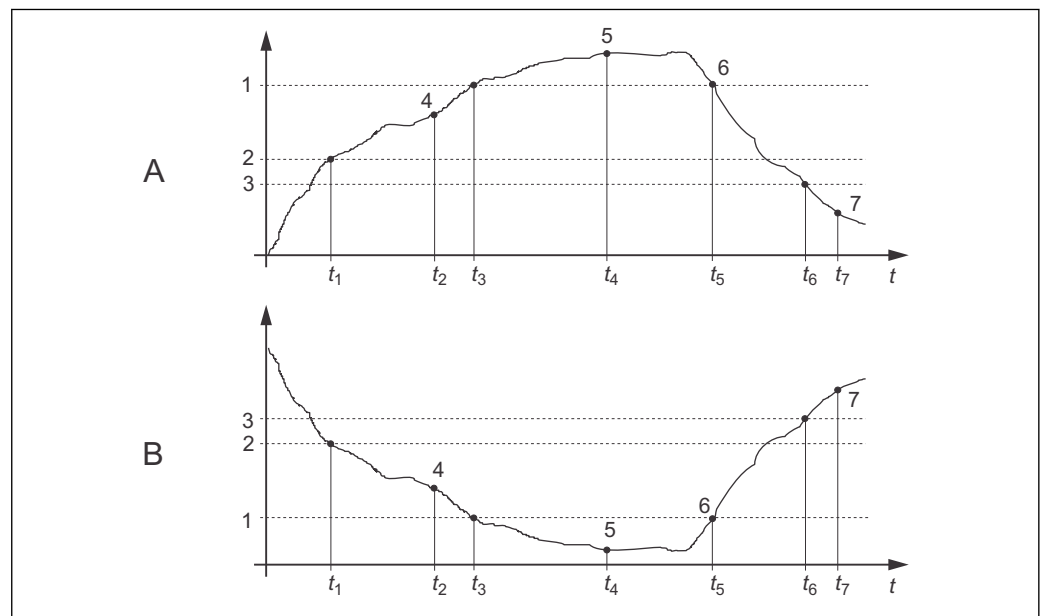

 38 Illustration of the alarm and limit value functions

- A Switch-on point > switch-off point: Max. function
- B Switch-on point < switch-off point: Min. function
- 1 Alarm threshold
- 2 Switch-on point
- 3 Switch-off value
- 4 Contact ON
- 5 Alarm ON
- 6 Alarm OFF
- 7 Contact OFF

P(ID) controller

You can define various controller functions for the transmitter. On the basis of the PID controller, P, PI, PD and PID controllers can be implemented. For an optimum control system, use the controller that best suits your application.

- **P controller**

Used for simple linear control purposes with small system deviations. Where major changes are to be controlled, overshooting may occur. In addition, a lasting control deviation must be expected.

- **PI controller**

Is used for control systems where overshooting is to be avoided and no lasting control deviation should occur.

- **PD controller**

Is used for processes that require quick changes and where peaks must be corrected.

- **PID controller**

Is used for processes where a P, PI or PD controller does not control sufficiently.

Configuration options of the P(ID) controller

The following configuration options are available for a PID controller:

- Change control gain K_p (P influence)
- Set integral action time T_n (I influence)
- Set derivative action time T_v (D influence)

Commissioning

If you do not yet have any experience for setting the control parameters, set the values that yield the greatest possible stability in the control circuit. Proceed as follows to optimize the control circuit further:

- Increase the control gain K_p until the controlled variable just starts to overshoot.
- Reduce K_p slightly again and then reduce the integral action time T_n so that the shortest possible correction time without overshooting is achieved.
- To reduce the response time of the controller, also set the derivative action time T_v .

Control and fine optimization of the set parameters with a recorder

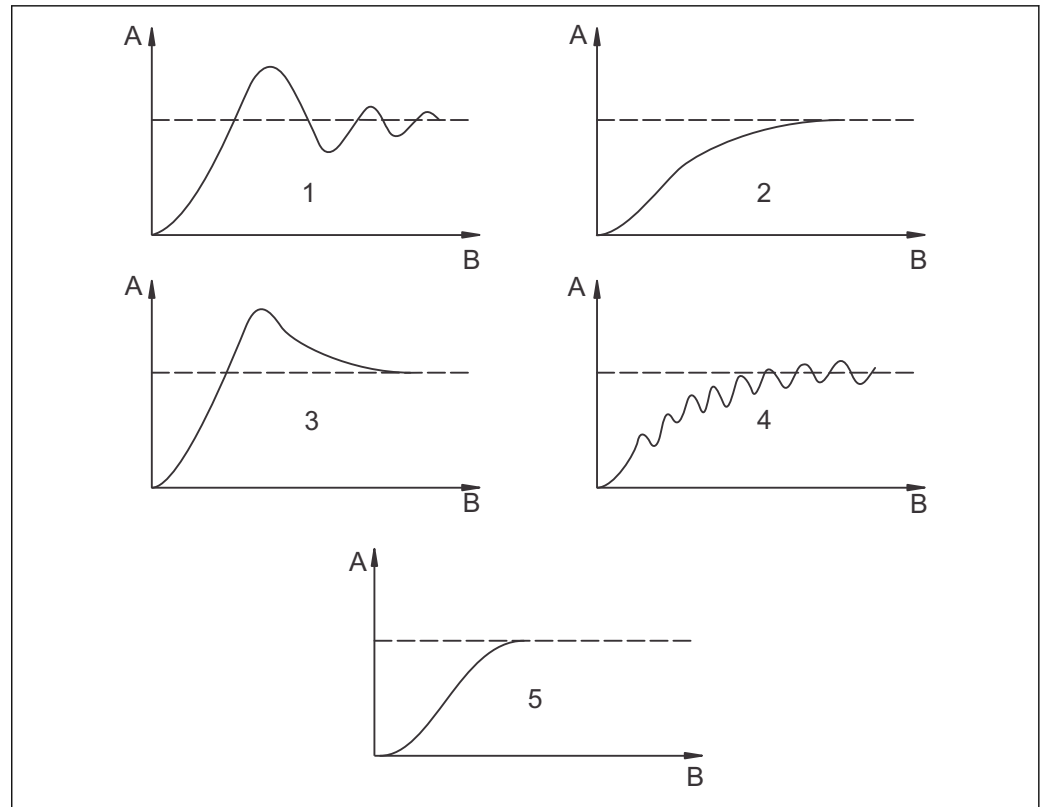

A0025218

39 Optimization of settings T_n and K_p

A Actual value

B Time

1 T_n too small

2 T_n too large

3 K_p too large

4 K_p too small

5 Optimum setting

Actuating signal outputs via contacts (R237 to R2310)

Each control contact outputs a cyclical signal whose intensity corresponds to the controller's actuating value. A distinction is made according to the type of signal cycle:

■ Pulse length modulation

The bigger the calculated manipulated variable is, the longer the contact affected remains picked up. The period T can be set to be between 0.5 and 99 s (field R238).

Outputs with pulse length modulation are used to activate solenoid valves.

■ Pulse frequency modulation

The bigger the calculated manipulated variable is, the higher the switching frequency of the contact affected. The maximum switching frequency $1/T$ can be set to be between 60 and 180 min^{-1} (field R239). The on-time t_{on} is constant. It depends on the set maximum frequency and is approx. 0.5 s for 60 min^{-1} and approx. 170 ms for 180 min^{-1} .

Outputs with pulse frequency modulation are used to activate directly controlled solenoid dosing pumps.

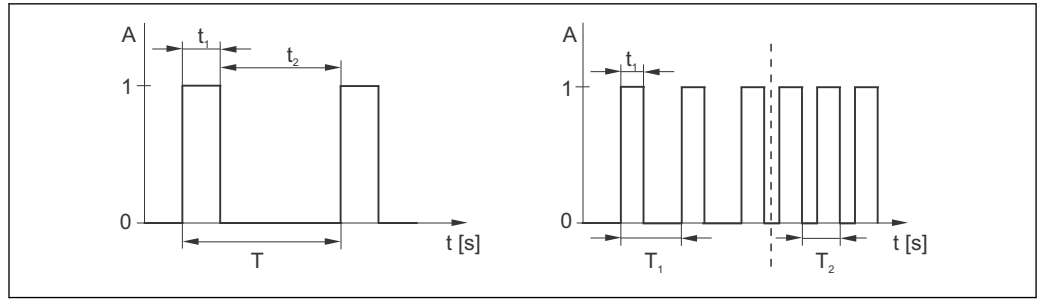

40 Signal of a pulse-length modulated controller contact (left) and of a pulse frequency-modulated controller contact (right)

Contact: 1 = on, 0 = off T Period
 Time (s): $t_1 = t_{on}$ $t_2 = t_{off}$ T_1 T_2 Impulse period length ($1/T_1$ and $1/T_2$)

Control characteristic for direct and inverse control action

You can choose between two control characteristics in the R236 field:

- Direct control action = maximum function
- Inverse control action = minimum function

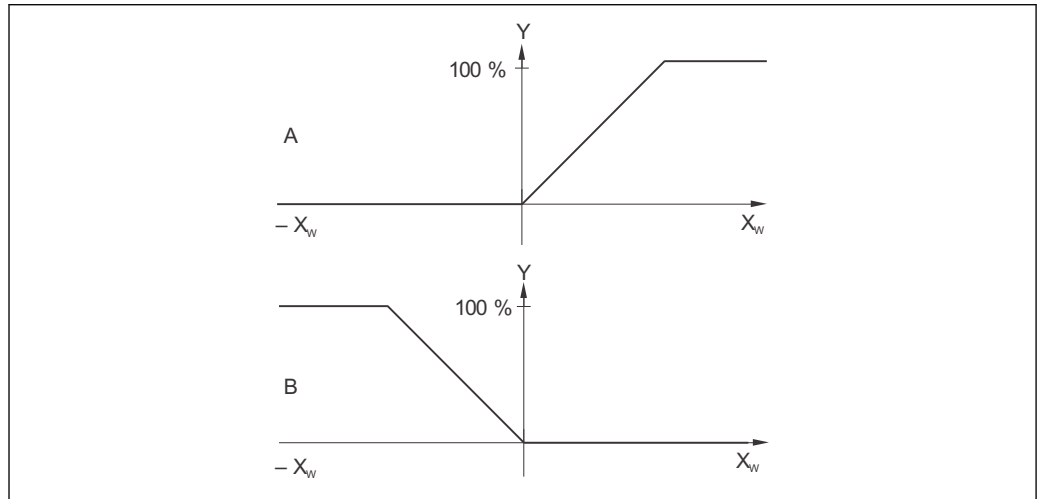

41 Control characteristic of a proportional controller with direct and inverse control action

A Direct = maximum function
 B Inverse = minimum function
 XW Control deviation
 Y Current output signal = controller actuating variable

Timer for cleaning function

This function includes a simple cleaning option. You can set the time interval after which cleaning should start. Therefore you can only select a constant interval sequence.

Other cleaning functions are available for selection in conjunction with the Chemoclean function (device version with four contacts required, see the "Chemoclean function" section).

i The timer and Chemoclean do not work independently of one another. While one of the two functions is active, the other cannot be started.

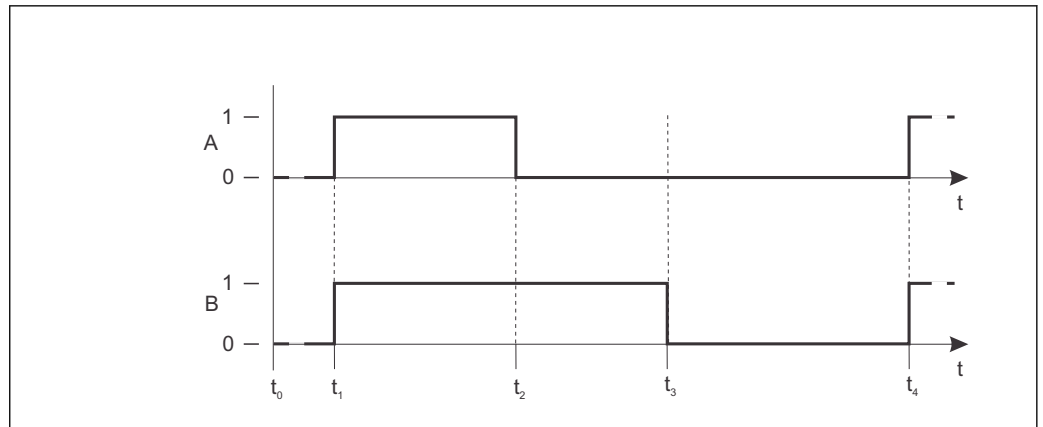

A0025223

42 Connection between cleaning time, pause time and hold dwell period

A Wiper and/or spray cleaning system

B Hold function

0 Inactive

1 active

t_0 Normal operation

t_1 cleaning start

t_2-t_1 Cleaning time

t_3-t_2 Clean hold dwell period (0 to 999 s)

t_4-t_3 Pause time between two cleaning intervals (1 to 7200 min)

Chemoclean function

Just like the timer function, Chemoclean can also be used to start a cleaning cycle. However, Chemoclean also gives you the added option of defining various cleaning and rinsing intervals and of dosing cleaning agent.

Therefore, it is possible to clean irregularly with different repeat cycles and to separately set the cleaning times with post rinse times.

Please note the following:

- To use the Chemoclean function the transmitter has to be equipped with a designated relay board (see product structure or chapter "accessories").
- The timer and Chemoclean are mutually dependent. While one of the two functions is active, the other cannot be started.
- For the Chemoclean function, the relays 3 (water) and 4 (cleaner) are used.
- If the cleaning is prematurely aborted, a post rinse time always follows.
- If the setting is "Economy", cleaning only takes place with water.

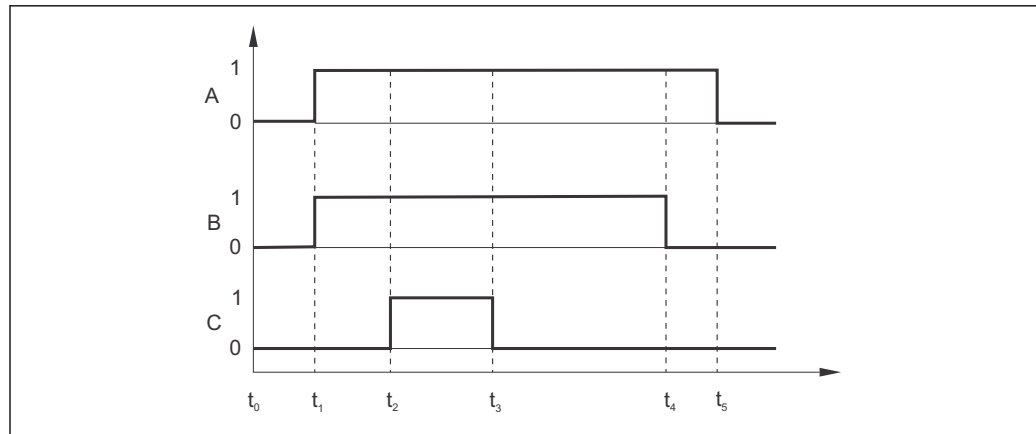

A0025216

43 Sequence of a cleaning cycle

- A Hold function
- B Water valve is triggered
- C Cleaning valve is triggered
- 0 Contact off
- 1 Contact on
- t0 Normal operation
- t1 cleaning start
- t2-t1 Pre-rinse time
- t3-t2 Cleaning time
- t4-t3 Post rinse time
- t5-t4 Hold dwell period

Neutralization controller

During neutralization control, the pH value of a medium is kept constant by dosing acid and alkali. Two separate actuating signals are required for this task, one for acid and one for alkali.

The neutralization controller is a controller with two relay contacts and is specially designed for this task. The P(ID) controller is available as the controller.

The values for the control gain K_p for acid and alkali can be set separately. The integral action time T_n and derivative action time T_v apply to both controllers (see the "P(ID) controller" section).

The "neutral zone" is located between the set values 1 and 2. There is no acid or alkali dosing ($Y=0$,) in the "neutral zone" with a controller without an integral component (P, PD). In the case of a controller with an integral component (PI, PID), there is constant alkali/acid dosing ($Y_{new}=Y_{old}$). The behavior of the I-component within the neutral zone depends on the process type (inline/batch).

The "neutral zone" can be shifted as desired in the X direction via set point 1 and 2.

i Neutralization control is only possible with relays 1 and 2.

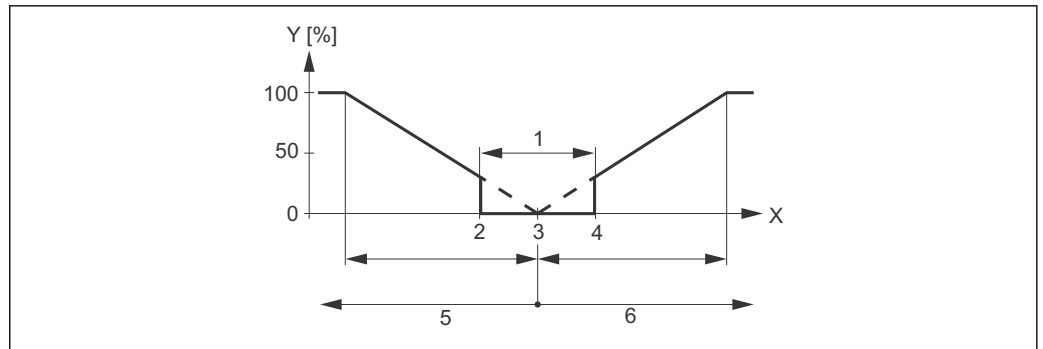



A0025220

44 Control characteristic of a proportional neutralization controller

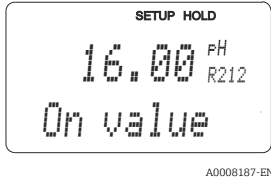
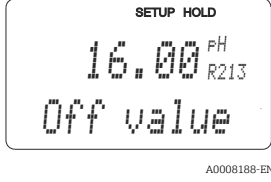
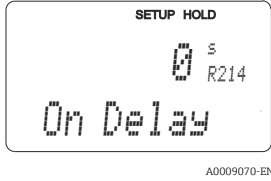
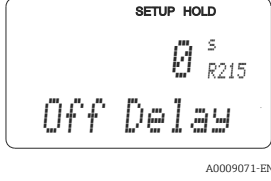

- 1 Neutral zone
- 2 Set point 1
- 3 Set point
- 4 Set point 2
- 5 Control contact 1 for alkali
- 6 Control contact 2 for acid

Functions marked in italics are not supported by the basic device version.

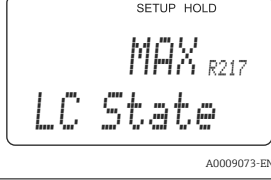
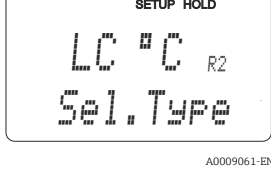
Coding	Field	Range of adjustment (factory settings in bold)	Display	Info
R	RELAY			Relay contact settings
R1	Select the contact to be configured	Rel1 Rel2 Rel3 Rel4		Rel3 (water) and Rel4 (cleaner) are only available with the relevant version of the transmitter. If Chemoclean is used as the cleaning method, Rel4 is not available.
R2 (1)	Configure limit contactor for pH/ORP measurement	LC PV = limit contactor pH/ORP (1) LC °C = limit contactor T (2) PID controller (3) Timer (4) <i>Clean= Chemoclean (5)</i> <i>Neutra controller (6)</i>		PV = process value If Rel4 is selected in the R1 field, Clean = Chemoclean cannot be selected. By confirming with ENTER, another relay function already switched on is switched off and its settings are reset to the factory settings.
R211	Switch function of R2 (1) off or on	Off On		All the settings are retained.

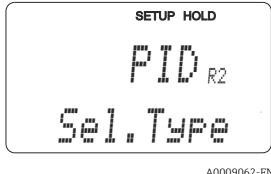
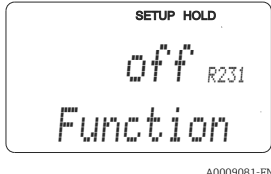

Coding	Field	Range of adjustment (factory settings in bold)	Display	Info
R212	Enter the switch-on point of the contact	pH 16.00 pH -2.00 to 16.00 1500 mV -1500 to 15000 100.0 % 0.0 to 100.0 %	 A0008187-EN	Never set the switch-on point and the switch-off point to the same value! (Only the operating mode selected in A1 is displayed.)
R213	Enter the switch-off point of the contact	pH 16.00 pH -2.00 to 16.00 1500 mV -1500 to 15000 100.0 % 0.0 to 100.0 %	 A0008188-EN	Entering a switch-off point selects either a Max contact (switch-off point < switch-on point) or a Min contact (switch-off point > switch-on point), thereby implementing a hysteresis that is constantly required (see "Illustration of the alarm and limit functions" figure).
R214	Enter pickup delay	0 s 0 to 2000 s	 A0009070-EN	
R215	Enter dropout delay	0 s 0 to 2000 s	 A0009071-EN	
R216	Enter alarm threshold	pH 16.00 pH -2.00 to 16.00 1500 mV -1500 to 15000 100.0 % 0.0 to 100.0 %	 A0008210-EN	If the alarm threshold is undershot/overshot, this triggers an alarm with the error message (E067 to E070) and an error current at the transmitter (note alarm delay in field F3). If defined as a Min contact, the alarm threshold must be < switch-off point.
R217	Display status for limit contactor	MAX MIN	 A0009073-EN	Display only
R2 (2)	Configure limit contactor for temperature measurement	LC PV = limit contactor pH/ORP (1) LC °C = limit contactor T (2) PID controller (3) Timer (4) Clean= Chemoclean (5) Neutra controller (6)	 A0009061-EN	By confirming with ENTER, another relay function already switched on is switched off and its settings are reset to the factory settings.

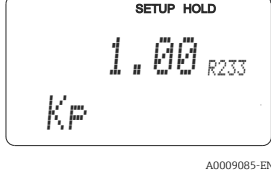
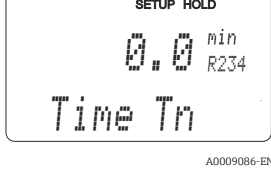
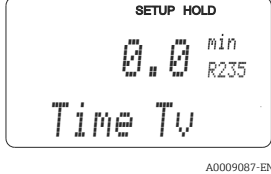
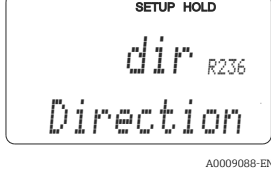
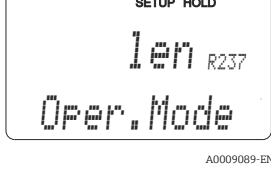

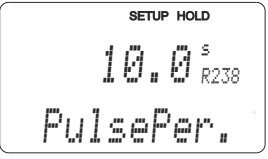
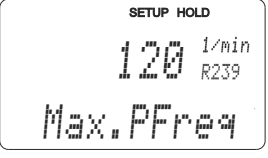
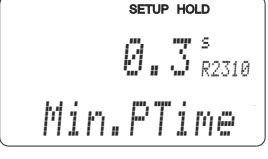
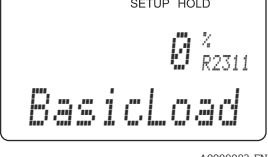
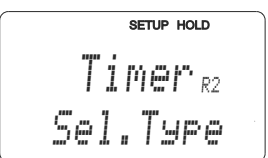
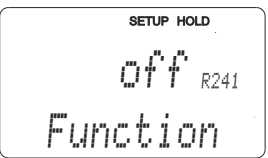
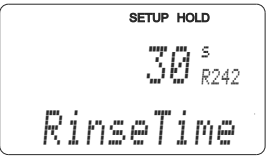
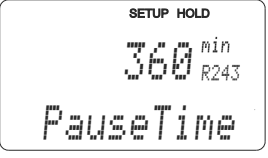
Coding	Field	Range of adjustment (factory settings in bold)	Display	Info
R221	Switch function of R2 (2) off or on	Off On	<p>SETUP HOLD off R221 Function</p> <p>A0009074-EN</p>	
R222	Enter switch-on temperature	150.0 °C -50.0 to 150.0 °C	<p>SETUP HOLD 150.0 °C R222 On value</p> <p>A0008214-EN</p>	Never set the switch-on point and the switch-off point to the same value!
R223	Enter switch-off temperature	150.0 °C -50.0 to 150.0 °C	<p>SETUP HOLD 150.0 °C R223 Off value</p> <p>A0008215-EN</p>	Entering a switch-off point selects either a Max contact (switch-off point < switch-on point) or a Min contact (switch-off point > switch-on point), thereby implementing a hysteresis that is constantly required (see "Illustration of the alarm and limit functions" figure).
R224	Enter pickup delay	0 s 0 to 2000 s	<p>SETUP HOLD 0 s R224 On Delay</p> <p>A0009077-EN</p>	
R225	Enter dropout delay	0 s 0 to 2000 s	<p>SETUP HOLD 0 s R225 Off Delay</p> <p>A0009078-EN</p>	
R226	Enter alarm threshold (as absolute value)	150.0 °C -50.0 to 150 °C	<p>SETUP HOLD 150.0 °C R226 A.Thresh</p> <p>A0008219-EN</p>	If the alarm threshold is undershot/overshot, this triggers an alarm with the error message (E067 to E070) and an error current at the transmitter (note alarm delay in field F3). If defined as a Min contact, the alarm threshold must be < switch-off point.
R227	Display status for limit contactor	MAX MIN	<p>SETUP HOLD MAX R227 LC State</p> <p>A0009080-EN</p>	Display only

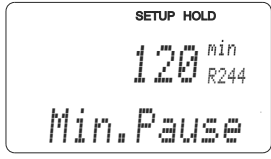
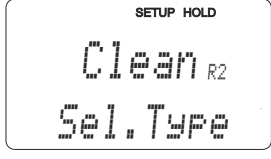
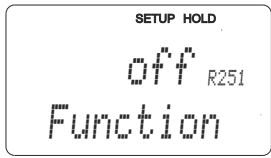
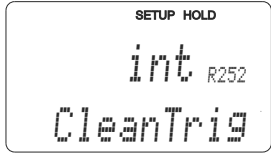
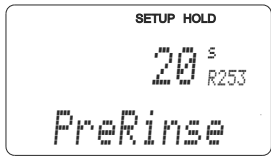
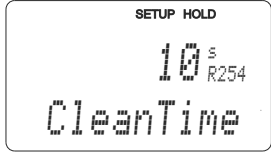
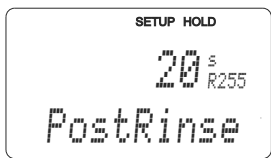
Coding	Field	Range of adjustment (factory settings in bold)	Display	Info
R2 (3)	Configure P(ID) controller	LC PV = limit contactor pH/ORP (1) LC °C = limit contactor T (2) PID controller (3) Timer (4) Clean= Chemoclean (5) Neutra controller (6)	 A0009062-EN	By confirming with ENTER, another relay function already switched on is switched off and its settings are reset to the factory settings.
R231	Switch function of R2 (3) off or on	Off On Basic PID+B	 A0009081-EN	On = PID controller Basic = basic load dosing PID+B = PID controller + basic load dosing
R232	Enter set point	pH 16.00 pH -2.00 to 16.00 1500 mV -1500 to 15000 0.0 % 0.0 to 100.0 %	 A0008226-EN	The set point is the value to be maintained by the control system. Using this control process, this value is restored when an upwards or downwards deviation occurs.
R233	Enter control gain K_p	1.00 0.01 to 20.00	 A0009085-EN	See the "P(ID) controller" section.
R234	Enter integral action time T_n (0.0 = no I-component)	0.0 min 0.0 to 999.9 min	 A0009086-EN	See the "P(ID) controller" section. With every hold, the I-component is set to zero. Although the hold can be deactivated in field S2, this does not apply for Chemoclean and timer!
R235	Enter derivative action time T_v (0.0 = no D-component)	0.0 min 0.0 to 999.9 min	 A0009087-EN	See the "P(ID) controller" section.
R236	Select controller characteristic	Dir = direct Inv = inverse	 A0009088-EN	The setting is required depending on the control deviation (upward or downward deviation, see the "P(ID) controller" section).
R237	Select pulse length or pulse frequency	Len = pulse length Freq = pulse frequency Curr = current output 2	 A0009089-EN	Pulse length e.g. for solenoid valve, pulse frequency e.g. for solenoid dosing pump, see the "Actuating signal outputs" section. Curr = current output 2 can only be selected if O2 = Contr.

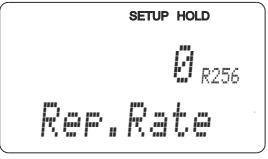
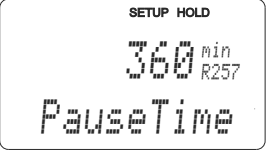
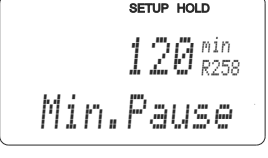
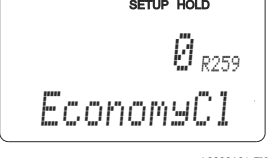
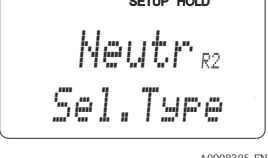
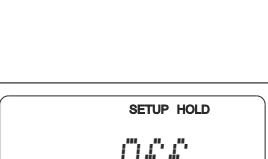
Coding	Field	Range of adjustment (factory settings in bold)	Display	Info
R238	Enter pulse interval	10.0 s 0.5 to 999.9 s	 <p>A0009090-EN</p>	This field only appears if pulse length is selected in R237. If pulse frequency is selected, R238 is skipped and entries continue with R239.
R239	Enter maximum pulse frequency of the adjuster	120 min⁻¹ 60 to 180 min ⁻¹	 <p>A0009091-EN</p>	This field only appears if pulse frequency is selected in R237. If pulse length is selected, R239 is skipped and entries continue with R2310.
R2310	Enter minimum switch-on time t _{ON}	0.3 s 0.1 to 5.0 s	 <p>A0009082-EN</p>	This field only appears if pulse length is selected in R237.
R2311	Enter basic load	0 % 0 to 40 %	 <p>A0009083-EN</p>	When you select the basic load, you enter the desired dosing quantity. 100% basic load would correspond to: <ul style="list-style-type: none"> Constantly on if R237 = len Fmax if R237 = freq (field R239) 20 mA if R237 = curr
R2 (4)	Configure cleaning function (timer)	LC PV = limit contactor pH/ORP (1) LC °C = limit contactor T (2) PID controller (3) Timer (4) Clean= Chemoclean (5) Neutra controller (6)	 <p>A0009063-EN</p>	Only one cleaning agent (generally water) is used for the cleaning. By confirming with ENTER, another relay function already switched on is switched off and its settings are reset to the factory settings.
R241	Switch function of R2 (4) off or on	Off On	 <p>A0009092-EN</p>	
R242	Enter rinsing/cleaning time	30 s 0 to 999 s	 <p>A0009093-EN</p>	Settings for hold and relay are active for this time.
R243	Enter pause time	360 min 1 to 7200 min	 <p>A0009094-EN</p>	The pause time is the time between two cleaning cycles (see the "Timer for cleaning function" section).

Coding	Field	Range of adjustment (factory settings in bold)	Display	Info
R244	Enter minimum pause time	120 min 1 to R243	 <p>A0009095-EN</p>	The minimum pause time prevents constant cleaning if a cleaning trigger is pending.
R2 (5)	Configure cleaning with Chemoclean (for version with four contacts, Chemoclean option and contacts 3 and 4 assigned)	LC PV = limit contactor pH/ORP (1) LC °C = limit contactor T (2) PID controller (3) Timer (4) Clean= Chemoclean (5) Neutra controller (6)	 <p>A0009064-EN</p>	See the "Chemoclean function" section. By confirming with ENTER, another relay function already switched on is switched off and its settings are reset to the factory settings.
R251	Switch function of R2 (5) off or on	Off On	 <p>A0009096-EN</p>	
R252	Select type of start pulse	Int = internal (time-controlled) Ext = external (digital input 2) I+ext = internal + external I+stp = internal, suppressed by external	 <p>A0009097-EN</p>	The cycle for the "int" function is started when the pause time ends (R257). No real time clock is available. External suppression is required for irregular time intervals (e.g. weekends).
R253	Enter pre-rinse time	20 s 0 to 999 s	 <p>A0009098-EN</p>	Rinsing is performed with water.
R254	Enter cleaning time	10 s 0 to 999 s	 <p>A0009099-EN</p>	Cleaning is performed with cleaning agent and water.
R255	Enter post rinse time	20 s 0 to 999 s	 <p>A0009100-EN</p>	Rinsing is performed with water.

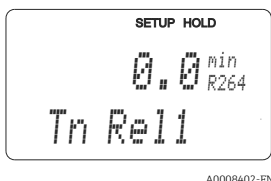
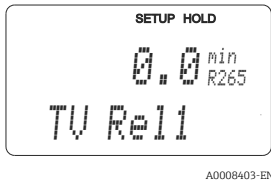
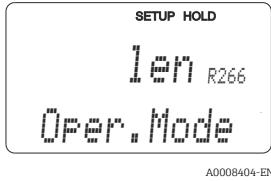
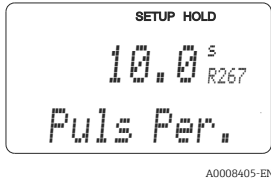
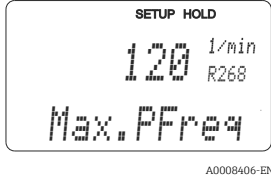
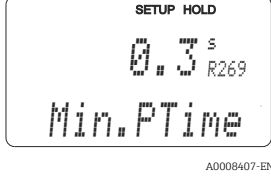
Coding	Field	Range of adjustment (factory settings in bold)	Display	Info
R256	Enter number of repeat cycles	0 0 to 5	 A0009101-EN	R253 to R255 is repeated.
R257	Enter pause time	360 min 1 to 7200 min	 A0009102-EN	The pause time is the time between two cleaning cycles (see the "Chemoclean function" section).
R258	Enter minimum pause time	120 min 1 to R257	 A0009103-EN	The minimum pause time prevents constant cleaning if an external cleaning start is pending.
R259	Enter number of cleaning cycles without cleaning agent (economy function)	0 0 to 9	 A0009104-EN	After cleaning with cleaner, up to 9 cleaning sessions can be carried out with water only until the next cleaning session with cleaner takes place.
R2 (6)	Configure neutralization controller	LC PV = limit contactor pH/ORP (1) LC °C = limit contactor T (2) PID controller (3) Timer (4) Clean= Chemoclean (5) Neutra controller (6)	 A0008395-EN	Only if A1 = pH. If neutra controller is selected for Rel1, only neutra controller is offered for Rel2. By confirming with ENTER, another relay function already switched on is switched off and its settings are reset to the factory settings.
R261	Switch function of R2 (6) off or on	Off On	 A0009105-EN	
R262	Enter set point 1 (or 2)	pH 6.00 pH -2.00 to 16.00	 A0008398-EN	Relay assignment 1 and 2 for neutra controller: Rel1 = set point 1 Rel2 = set point 2
R263	Enter control gain K _{p1} (or K _{p2})	1.00 0.10 to 20.00	 A0008401-EN	Relay assignment 1 and 2 for neutra controller: Rel1 = Kp1 Rel2 = Kp2

Coding	Field	Range of adjustment (factory settings in bold)	Display	Info
R264	Enter <i>integral action time</i> T_{n1} (or T_{n2}) (0.0= no I-component)	0.0 min 0.0 to 999.9 min	 <p>A0008402-EN</p>	Relay assignment 1 and 2 for neutra controller: Rel1 = Tn1 Rel2 = Tn2
R265	Enter <i>derivative action time</i> T_v1 (or T_v2) (0.0= no D-component)	0.0 min 0.0 to 999.9 min	 <p>A0008403-EN</p>	Relay assignment 1 and 2 for neutra controller: Rel1 = Tv1 Rel2 = Tv2
R266	Select <i>pulse length or pulse frequency</i>	Len = pulse length Freq = pulse frequency Curr = current output 2	 <p>A0008404-EN</p>	Pulse length e.g. for solenoid valve, pulse frequency e.g. for solenoid dosing pump, see the "Actuating signal outputs" section. Curr = current output 2 can only be selected if O2 = Contr.
R267	Enter <i>pulse interval</i>	10.0 s 0.5 to 999.9 s	 <p>A0008405-EN</p>	This field only appears if pulse length is selected in R266. If pulse frequency is selected, R267 is skipped and entries continue with R268.
R268	Enter <i>maximum pulse frequency of the adjuster</i>	120 min⁻¹ 60 to 180 min ⁻¹	 <p>A0008406-EN</p>	This field only appears if pulse frequency is selected in R266. If pulse length is selected, R268 is skipped and entries continue with R269.
R269	Enter <i>minimum switch-on time</i> t_{ON}	0.3 s 0.1 to 5.0 s	 <p>A0008407-EN</p>	This field only appears if pulse length is selected in R266.
R2610	Enter <i>process type</i>	Batch Inline	 <p>A0008397-EN</p>	Batch = discontinuous process Inline = continuous process There is no further dosing in the setting range in batch mode. The I-component is decreased. Dosing continues in the setting range in inline mode. The I-component is effective.

7.6.8 Service

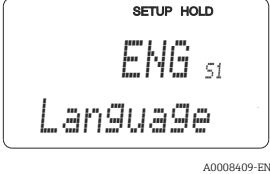
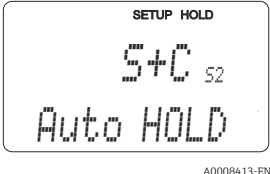
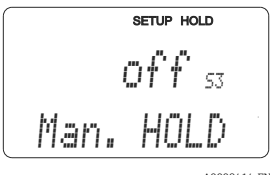
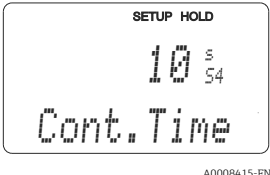
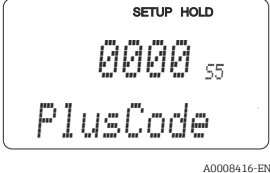
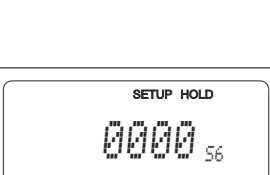
Coding	Field	Range of adjustment (factory settings in bold)	Display	Info
S	SERVICE function group		 A0008408-EN	Service function settings.
S1	Select language	ENG = English GER = German FRA = French ITA = Italian NL = Dutch ESP = Spanish	 A0008409-EN	The option selected only applies for the fault-signaling contact, not for the error current.
S2	Configure a hold	S+C = hold during configuration and calibration Cal = hold during calibration Setup = hold during configuration None = no hold	 A0008413-EN	S = setup C = calibration
S3	Manual hold	Off On	 A0008414-EN	The setting is retained even in the event of a power failure.
S4	Enter hold dwell period	10 s 0 to 999 s	 A0008415-EN	
S5	Enter SW upgrade release code (Plus Package)	0000 0000 to 9999	 A0008416-EN	The code can be found on the nameplate. If an incorrect code is entered, you are taken back to the measurement menu. The number is edited with the PLUS or MINUS key and confirmed with the ENTER key. "1" is displayed if the code is active.
S6	Enter SW upgrade release code for Chemoclean	0000 0000 to 9999	 A0008417-EN	The code can be found on the nameplate. If an incorrect code is entered, you are taken back to the measurement menu. The number is edited with the PLUS or MINUS key and confirmed with the ENTER key. "1" is displayed if the code is active.

Coding	Field	Range of adjustment (factory settings in bold)	Display	Info
S7	Order number is displayed		<p>A0008418-EN</p>	If the device is upgraded, the order code is changed automatically.
S8	Serial number is displayed		<p>A0008420-EN</p>	
S9	Reset the device to the basic settings	No Sens = sensor data Facy = factory settings	<p>A0008421-EN</p>	Sens = last calibration is deleted and is reset to factory setting. Facy = all data (apart from A1 and S1) are deleted and reset to the factory setting!
S10	Perform device test	No Displ = display test	<p>A0008410-EN</p>	
S11	Reference voltage is displayed	Current value in mV	<p>A0008411-EN</p>	This is used to check the reference potential. Value > 50 mV indicates galvanic voltage in the medium. High values (> 1000 mV) may falsify the measured value.
S12	Select AC frequency	50 Hz 60 Hz	<p>A0008412-EN</p>	Only select 60 Hz if the frequency of the voltage at the place of use is 60 Hz, the measured value is fluctuating or sporadic SCS errors are reported.

7.6.9 E+H Service

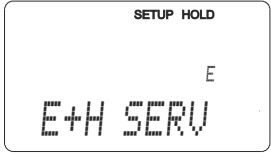
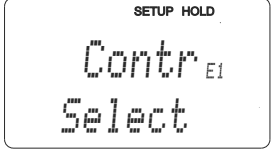
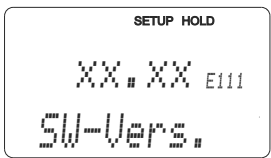
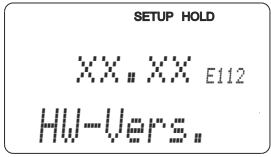
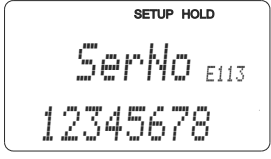
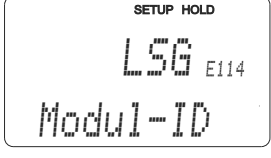
Coding	Field	Range of adjustment (factory settings in bold)	Display	Info
E	E+H SERVICE function group		 <p style="text-align: right; font-size: small;">A0007857-EN</p>	Information on the device version
E1	Select module	Contr = controller (central module) (1) Trans = transmitter (2) Main = power unit (3) Rel = relay module (4) Sens = sensor (5)	 <p style="text-align: right; font-size: small;">A0007858-EN</p>	The "Sens = sensor" option is only available on devices with Memosens functionality.
E111 E121 E131 E141 E151	Software version is displayed		 <p style="text-align: right; font-size: small;">A0007859-EN</p>	If E1 = contr: device software If E1 = trans, main, rel: module firmware If E1 = sens: sensor software
E112 E122 E132 E142 E152	Hardware version is displayed		 <p style="text-align: right; font-size: small;">A0007861-EN</p>	Info display
E113 E123 E133 E143 E153	Serial number is displayed		 <p style="text-align: right; font-size: small;">A0007860-EN</p>	Info display
E114 E124 E134 E144 E154	Module ID is displayed		 <p style="text-align: right; font-size: small;">A0007862-EN</p>	Info display

7.6.10 Interfaces

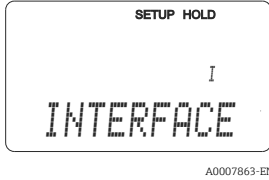
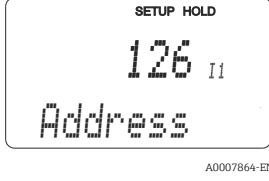
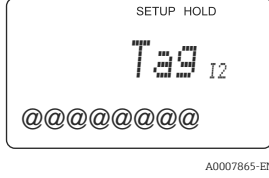
Coding	Field	Range of adjustment (factory settings in bold)	Display	Info
I	INTERFACE function group			Communication settings (only for HART or PROFIBUS device version).
I1	Enter bus address	Address HART: 0 to 15 or PROFIBUS: 0 to 126		Each address may only be assigned once in a network. If a device address ≠ 0 is selected for a HART device, the current output is automatically set to 4 mA and the device prepares for multi-drop operation.
I2	The tag name is displayed			

7.6.11 Communication

For devices with a communication interface, please also refer to the separate Operating Instructions BA00208C/07/EN (HART®) or BA00209C/07/DE (PROFIBUS®).

7.7 Calibration

Use the CAL key to access the calibration function group.

Use this function group to calibrate the sensor. The calibration can be performed in a number of ways:

- By measuring in two calibration solutions with known pH value.
- By entering data for the slope and zero point
- In the case of ORP measurement, by entering the mV value or two different % values

Please note the following:

- During initial commissioning of amperometric sensors, calibration is absolutely essential (except for sensors with Memosens functionality) so that the measuring system can return precise measurement data.
- If the calibration is aborted by simultaneously pressing the PLUS and MINUS keys (return to C19, C25 or C36), or if the calibration is faulty, the original calibration data are used again. A calibration error is indicated by "ERR" and the sensor symbol flashes on the display.
Repeat calibration!
- For each calibration, the device automatically switches to hold (factory setting).
- Any offset set is automatically deleted after the calibration is accepted.
- If the slope or zero point are outside the ranges given in C16 and C17, error 32 becomes active in the case of the slope or error 33 becomes active in the case of the zero point. The electrode must then be checked and replaced if necessary.
- If precalibrated digital sensors (Memosens functionality) are connected, the calibration data are automatically transmitted to the transmitter.

Points to note when calibrating ISFET sensors

Switch-on behavior

A closed-control loop is created when the measuring system is switched on. The measured value adjusts to the real value during this time (approx. 5 to 8 minutes). This settling behavior occurs every time the liquid film between the pH-sensitive semiconductor and the reference lead is interrupted (e.g. caused by dry storage or intensive cleaning with compressed air). The settling time depends on the length of the interruption.

Sensitivity to light

Like all semiconductor components, the ISFET chip is sensitive to light (measured value variations). However, this only affects the measured value if the sensor is directly exposed to sunlight. For this reason, avoid direct sunlight when calibrating. Normal ambient light does not have any effect on the measurement.

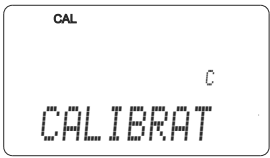
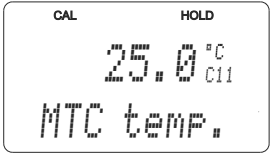
Coding	Field	Range of adjustment (factory settings in bold)	Display	Info
C (1)	CALIBRATION function group:	pH calibration	 <p style="text-align: right; font-size: small;">A0009141-EN</p>	Only if A1 = pH. Calibration with two different buffer solutions.
C11	Enter calibration temperature	25.0 °C -50.0 to 150.0 °C	 <p style="text-align: right; font-size: small;">A0007837-EN</p>	Only if B1 = MTC.

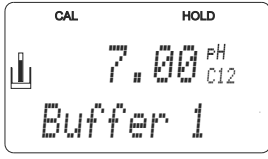
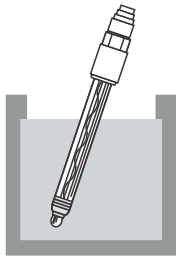
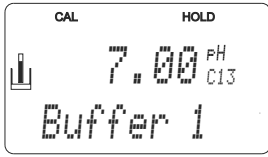
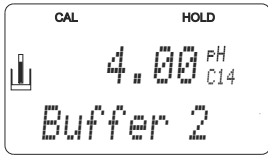
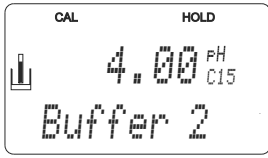
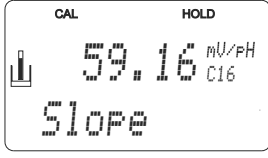
Coding	Field	Range of adjustment (factory settings in bold)	Display	Info
C12	Enter pH value of the first buffer solution	Buffer value of the last calibration pH 0.00 to 14.00	 A0007838-EN	You can edit the displayed value. The value is specified by the corresponding buffer solution.
Insert the electrode into the buffer indicated. In the case of ATC operation, the temperature sensor must also be immersed in the buffer solution. Press CAL to display the current measured value. Then start the calibration with CAL.			 A0025778	In the case of symmetrical measuring operation, the potential matching pin must also be immersed in the buffer.
C13	Calibration is performed The display flashes		 A0007839-EN	Stability check: The value is accepted if the stability level is \leq pH 0.05 for more than 10 seconds.
Manual continuation: if the value becomes stable, you can accept the calibration for buffer solution 1 with the CAL key. Automatic continuation: takes place if the value is stable (difference between measured values \leq 0.05 and constant value over 10 s). If the value does not stabilize within 5 min, error 44 is set and the calibration is aborted.				
C14	Enter pH value of the second buffer solution	Buffer value of the last calibration pH 0.00 to 14.00	 A0007840-EN	The pH value of the buffer must be different to that of buffer 1. A plausibility check takes place.
Proceed with buffer 2 as with buffer 1.				
C15	Calibration is performed The display flashes		 A0007841-EN	Accepted if stability \leq \pm pH 0.05 for more than 10 s.
C16	Slope is displayed	Normal values: Glass: 59.16 mV/pH 38.00 to 65.00 mV/pH Antimony: 59.16 mV/pH 25.00 to 65.00 mV/pH ISFET: 59.16 mV/pH 38.00 to 65.00 mV/pH	 A0007842-EN	
Press CAL.				

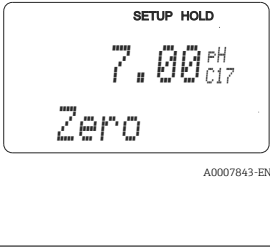
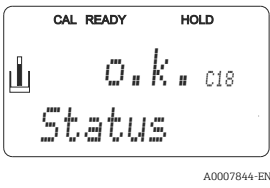
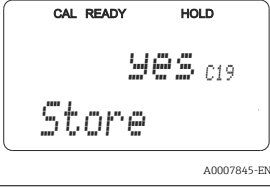
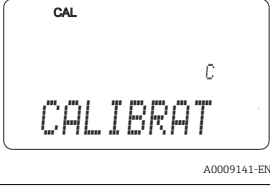
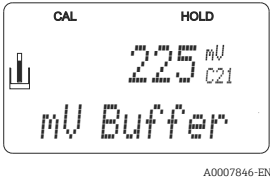
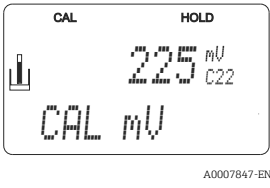
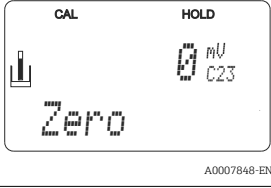
Coding	Field	Range of adjustment (factory settings in bold)	Display	Info
C17	Zero point (zero point / U _{is}) is displayed	Normal values: Glass: pH 7.00 pH 5.00 to 9.00 Antimony: pH 1.00 pH -1.00 to 3.00 ISFET: current value -500 to +500 mV		For ISFET, the zero point is displayed in mV.
Press CAL.				
C18	Calibration status is displayed	o.k. E xxx		
Press CAL.				
C19	Store calibration result?	Yes No New		If C18 = E xxx, then only No or New . If New, return to C. If Yes/No, return to "Measurement".
The electrode can now be reinstalled in the process.				
C (2)	CALIBRATION function group:	ORP mV calibration		Only if A1 = ORP (mV).
The transmitter has a calibrated mV display range. An absolute mV value with a single buffer solution (adjustment of measuring chain offset) is set. Here, a buffer solution is used, preferably with 225 or 475 mV.				The maximum permitted calibration offset is ±100 mV.
C21	Enter the mV value belonging to the ORP buffer used	Current measured value 1500 to 1500 mV		In the case of symmetrical measuring operation, the potential matching pin must also be immersed in the buffer.
C22	Calibration is performed The display flashes	mV value		Stability check: The value is accepted if the stability level is ≤ ±1 mV for more than 10 seconds.
C23	Zero point is displayed	-100 to 100 mV		

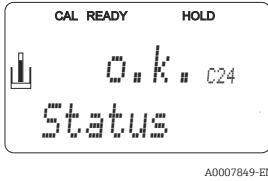
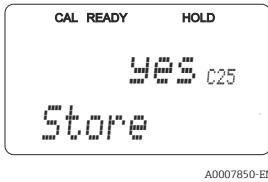
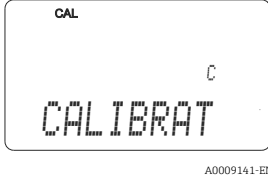
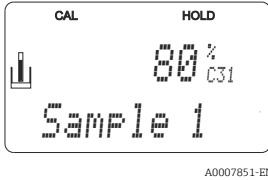
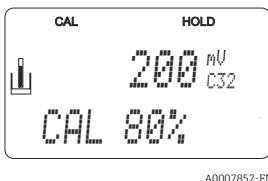
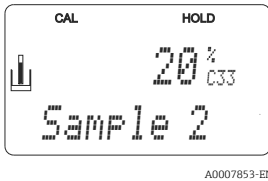
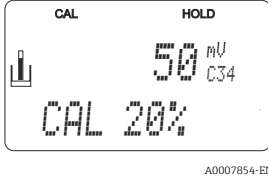
Coding	Field	Range of adjustment (factory settings in bold)	Display	Info
C24	Calibration status is displayed	o.k. E xxx		
Press CAL.				
C25	Store calibration result?	Yes No New		If C24 = E xxx, then only No or New . If New, return to C. If Yes/No, return to "Measurement".
C (3)	CALIBRATION function group:	ORP % calibration		Sensor adjustment with compensation for wall effects.
For the calibration, a sample of the medium is taken in two containers. The contents of the first container is detoxified. The contents of the second container remains unchanged. A relative value of 80 % is set with the "toxic" sample. A relative value of 20 % is set with the "non-toxic" sample.			Default values: 0 % = -1000 mV 100 % = +1000 mV	The calibration range is ± 1500 mV, the minimum difference should be 60 mV.
C31	Determine 80% value of the "toxic" sample	80%		Start the calibration with the "toxic" sample by pressing the CAL key. The value is accepted as soon as it is stable or confirmed with the CAL key (see calibration pH).
C32	Calibration is performed The display flashes	mV value is displayed		Stability check: The value is accepted if the stability level is $\leq \pm 5$ mV for more than 10 seconds.
C33	Determine 20% value of the "toxic" sample	20%		The procedure for C31 is repeated with the "non-toxic" sample to calibrate value 2.
C34	Calibration is performed The display flashes	mV value is displayed		Stability check: The value is accepted if the stability level is $\leq \pm 5$ mV for more than 10 seconds.

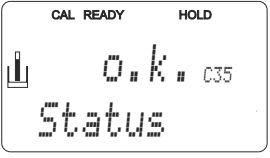
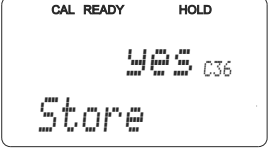
Coding	Field	Range of adjustment (factory settings in bold)	Display	Info
C35	Calibration status is displayed	o.k. E xxx	 <p style="text-align: right; font-size: small;">A0007855-EN</p>	
Press CAL.				
C36	Store calibration result?	Yes No New	 <p style="text-align: right; font-size: small;">A0007856-EN</p>	If C24 = E xxx, then only No or New . If New, return to C. If Yes/No, return to "Measurement".

7.7.1 Numeric calibration

During numerical calibration, the slope and zero point can be corrected manually.

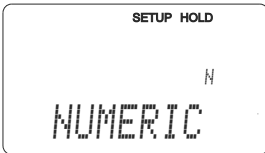
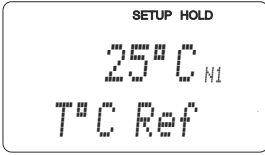
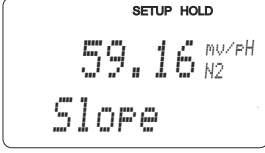
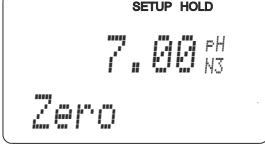
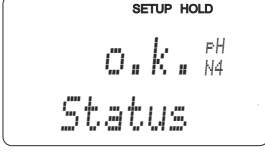
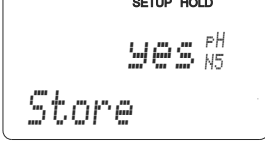
Coding	Field	Range of adjustment (factory settings in bold)	Display	Info
N	NUMERICAL CALIBRATION		 A0007866-EN	
N1	Enter reference temperature	25.0 °C -50.0 to 150.0 °C	 A0007867-EN	
N2	Enter slope	Glass: 59.16 mV/pH 38.00 to 65.00 mV/pH Antimony: 59.16 mV/pH 25.00 to 65.00 mV/pH ISFET: 59.16 mV/pH 38.00 to 65.00 mV/pH	 A0007868-EN	If A4 = ISFET: enter the slope from the quality certificate.
N3	Enter zero point	Normal values: Glass: pH 7.00 pH 5.00 to 9.00 Antimony: pH 1.00 pH -1.00 to 3.00 ISFET: 0 mV -500 to +500 mV	 A0007869-EN	If A4 = ISFET: enter the voltage U _{IS} from the quality certificate.
N4	Calibration status is displayed	o.k. E xxx	 A0007870-EN	
Press CAL.				
N5	Store calibration result	Yes No New	 A0007871-EN	

7.7.2 Offset

The settings in the OFFSET function group can be used to adjust the measurement to a reference measurement. This requires a linear shift of all the measured values, i.e. the adjustment is determined for one measured value, and all others are calculated using the same adjustment.

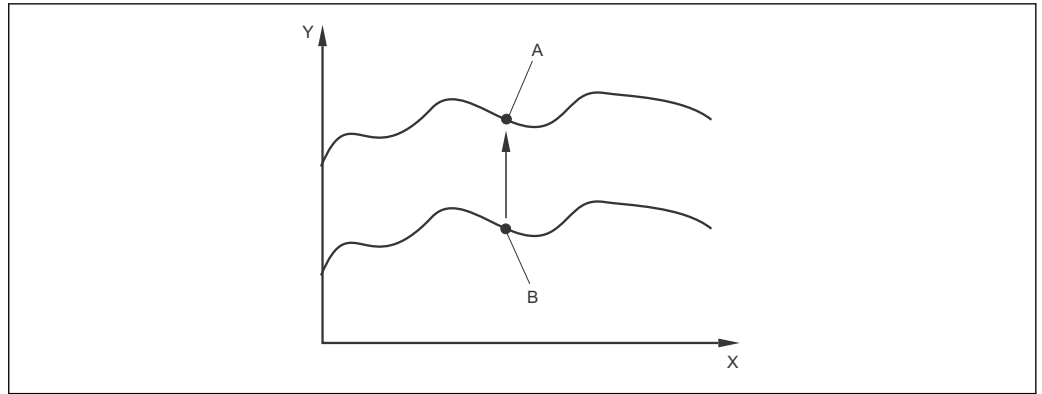

A0025780

45 Offset

- X Time
- Y Measured value
- A Adjusted value
- B Current measured value

Coding	Field	Range of adjustment (factory settings in bold)	Display	Info
V	OFFSET function group for pH or ORP		<p>A0008422-EN</p>	Depending on the operating mode selected, either pH or ORP appears (i.e. no direct selection can be made)
V1	Enter desired measured value	Current measured value pH -2.00 to 16.00 -1500 to 1500 mV 0.0 to 100.0 %	<p>A0008423-EN</p>	You can edit the display. The entry can differ from the actual value by a maximum of ±2.0 pH / ±120 mV / ±50 %.
V2	Current offset is displayed	pH 0.00 pH -2.00 to 2.00 0 mV -120 to 120 mV 0.0 % -50.0 to 50.0 %	<p>A0008424-EN</p>	
V3	Calibration status is displayed	o.k. E xxx	<p>A0008425-EN</p>	
Press CAL.				
V4	Store calibration result	Yes No New	<p>A0008426-EN</p>	If V3 = E xxx, then only No or New. If New, return to V. If Yes/No, return to "Measurement".

8 Diagnostics and troubleshooting

8.1 Trouble shooting instructions

The transmitter continuously monitors its functions itself. If an error occurs which the device recognizes, this is indicated on the display. The error number is shown below the display of the main measured value. If more than one error occurs, you can call these up with the MINUS key.

Refer to the "System error messages" table for the possible error numbers and remedial measures.

Should a malfunction occur without any transmitter error message, please refer to the "Process-specific errors" or the "Device-specific errors" tables to localize and rectify the error. These tables provide you with additional information on any spare parts required.

8.2 System error messages

You can display and select the error messages with the MINUS key.

Error No.	Display	Tests/remedial action	Alarm contact	Error current	Autom. cleaning start	PROFIBUS Status
			Facty	Facty	Facty	PV ¹⁾
			User	User	User	Temp
E001	EEPROM memory error	<ul style="list-style-type: none"> ▪ Switch off device and switch it on again. ▪ Load software compatible with hardware 	Yes	No	X	0C
					X	0C
E002	Device not calibrated, calibration data invalid, no user data or user data invalid (EEPROM error), device software not suitable for hardware (controller)	<ul style="list-style-type: none"> ▪ Load measurement-parameter specific device software. ▪ If the error persists, send in the device for repair to your local sales center or replace the device. 	Yes	No	X	0C
					X	0C
E003	Download error	Invalid configuration. Repeat download.	Yes	No	No	0C
						0C
E004	Device software version not compatible with module hardware version	Load software compatible with hardware Load measurement-parameter specific device software.	Yes	No	No	0C
						0C
E007	Transmitter malfunction, device software not compatible with transmitter version		Yes	No	X	0C
					X	0C
E008	SCS alarm: Glass electrode: glass breakage ISFET: leak current > 400 nA	Check glass electrode for glass breakage or hair-line cracks; inspect electrode plug-in head for moisture and dry if necessary; check medium temperature. Replace ISFET.	Yes	No	No	0C
						80
E010	Temperature sensor defective, not	Check temperature sensor and connections; check the measuring device and	Yes	No	No	80

Error No.	Display	Tests/remedial action	Alarm contact	Error current	Autom. cleaning start	PROFIBUS Status
			Facty	Facty	Facty	PV ¹⁾
			User	User	User	Temp
	connected or short-circuited	measuring cable with a temperature simulator if necessary. Check that correct option is selected in field A5				OC
E029	Sensor self-test	The digital sensor encountered an error during the self-test. Check the sensor and replace if necessary.	Yes	No	X	OC
					X	OC
E030	SCS reference electrode warning	Check reference electrode for contamination and damage; clean the reference electrode.	Yes	No	No	OC
						80
E032	Upper or lower pH slope range exceeded	Repeat calibration and replace buffer solution; if necessary, replace sensor and check the device and measuring cable with a simulator.	No	No	X	80
					X	80
E033	pH value zero point too low or too high		No	No	X	80
					X	80
E034	ORP offset range exceeded or below range		No	No	X	80
					X	80
E041	Calculation of calibration parameters aborted	Repeat calibration and replace buffer solution; replace sensor if necessary, check device and measuring cable.	No	No	X	80
					X	80
E042	Distance between buffer value and zero point (pH7) too small (single-point calibration)	For slope calibration, use a buffer solution which has at least a distance of $\Delta\text{pH} = 2$ to the electrode zero point.	No	No	X	80
					X	80
E043	Distance between buffer 1 and buffer 2 calibration values too small (two-point calibration)	Use buffer solutions which differ by at least $\Delta\text{pH} = 2$.	No	No	X	80
					X	80
E044	Stability requirement not met during calibration	Repeat calibration and replace buffer solution; if necessary, replace sensor and check the device and measuring cable with a simulator.	No	No	X	80
					X	80
E045	Calibration aborted		No	No	X	80
					X	80
E046	Parameter limits of current output 1 mixed up	Correct the settings	No	No	X	80
					X	80
E047	Parameter limits of current output 2 mixed up		No	No	X	80
					X	80
E055	Below main parameter measuring range	Check measurement, control and connections	Yes	No	No	44
						80
E057	Main parameter measuring range exceeded		Yes	No	No	44
						80

Error No.	Display	Tests/remedial action	Alarm contact	Error current	Autom. cleaning start	PROFIBUS Status
			Facty	Facty	Facty	PV ¹⁾
			User	User	User	Temp
E059	Below temperature measuring range		Yes	No	No	80
						44
E061	Temperature measuring range exceeded		Yes	No	No	80
						44
E063	Below current output range 1	Check measured value and current assignment	Yes	No	No	80
						80
E064	Current output range 1 exceeded		Yes	No	No	80
						80
E065	Below current output range 2		Yes	No	No	80
						80
E066	Current output range 2 exceeded		Yes	No	No	80
						80
E067	Set point exceeded limit contactor 1	Check configuration	Yes	No	No	80
						80
E068	Set point exceeded limit contactor 2		Yes	No	No	80
						80
E069	Set point exceeded limit contactor 3		Yes	No	No	80
						80
E070	Set point exceeded limit contactor 4		Yes	No	No	80
						80
E080	Current output 1 range too small	Increase range in "Current outputs" menu.	Yes	No	X	80
					X	80
E081	Current output 2 range too small		Yes	No	X	80
					X	80
E085	Incorrect setting for error current	If the current range "0 to 20 mA" was selected in field O311, the error current may not be set to "2.4 mA".	Yes	No	No	80
						80
E094	Incompatible sensor version	Digital sensor and transmitter not compatible. Possibly, Ex version of sensor is used with non-Ex version of transmitter or vice versa.	Yes	No	No	0C
						0C
E100	Current simulation active		Yes	No	X	80
					X	80
E101	Service function active	Switch off service function or switch device off and then on again.	No	No	X	80
					X	80
E102	Manual mode active		No	No	X	80
					X	80
E106	Download active	Wait for download to finish.	No	No	X	80

Error No.	Display	Tests/remedial action	Alarm contact	Error current	Autom. cleaning start	PROFIBUS Status
			Facty	Facty	Facty	PV ¹⁾
			User	User	User	Temp
					X	80
E116	Download error	Repeat download.	Yes	No	X	OC
					X	OC
E127	Memosens powerfail; sensor communication present but sensor has too little current	Check whether the Memosens connection is correctly inserted and locked.	Yes	No	No	OC
						OC
E147	Sensor communication faulty	Check that the sensor is correctly connected, the cable ends are correctly wired at the terminals and the cable is not damaged.	Yes	No	No	OC
						OC
E152	PCS alarm	Check sensor and connection.	Yes	No	No	44
						44
E153	Calibration offset out of limits	<ul style="list-style-type: none"> ▪ Repeat calibration. ▪ Check the calibration solutions if necessary. ▪ Replace sensor. 	No	No	No	80
						80
E154	Below lower alarm threshold for period exceeding alarm delay	Perform manual comparison measurement if necessary. Service sensor and recalibrate.	Yes	No	No	X
						X
E155	Above upper alarm threshold for period exceeding alarm delay		Yes	No	No	X
						X
E156	Actual value undershoots alarm threshold for longer than the set permissible maximum period		Yes	No	No	X
						X
E157	Actual value exceeds alarm threshold for longer than the set permissible maximum period		Yes	No	No	X
						X
E162	Dosage stop	Check settings in the CURRENT INPUT and CHECK function groups.	Yes	No	No	X
						X
E171	Flow in main stream too low or zero	Restore flow.	Yes	No	No	X
						X
E172	Switch-off limit for current input exceeded	Check process variables at sending measuring device. Change range assignment if necessary.	Yes	No	No	X
						X
E173	Current input < 4 mA		Yes	No	No	X
						X
E174	Current input > 20 mA		Yes	No	No	X
						X
E175	SCS glass warning	Check electrode for glass breakage or hair-line cracks; check medium temperature.	No	No	No	44

Error No.	Display	Tests/remedial action	Alarm contact	Error current	Autom. cleaning start	PROFIBUS Status
			Facty	Facty	Facty	PV ¹⁾
			User	User	User	Temp
		Measurement can continue until the error occurs.				80
E177	SCS reference electrode warning	Check electrode for contamination and damage; clean electrode; measuring can continue until the error occurs.	No	No	No	44
						80
E180	Data error sensor	No measured value from digital sensor. Sensor possibly plugged in or connected incorrectly; or sensor is defective → replace sensor.	Yes	No	No	0C
						0C

1) PV = process variable, primary value

8.3 Process-specific errors

Use the following table to localize and rectify any errors occurring.

Error	Possible cause	Tests/remedial action	Tools, spare parts
Device cannot be operated, display value 9999	Operation locked	Press CAL and MINUS keys simultaneously	See the "Key functions" section
Measuring chain zero-point cannot be adjusted	Contaminated reference system	Test with new sensor	pH/ORP sensor
	Membrane clogged	Clean or grind membrane	HCl 3 %, use file (only file in one direction)
	Measuring line open	Short-circuit pH input on device → display pH 7	
	Asymmetric sensor voltage too high	Clean junction or test with another sensor	HCl 3 %, use file (only file in one direction)
	Incorrect potential matching (PA/PM) for transmitter ↔ medium	Asymm.: no PM or PM at PE Symm.: PM connection mandatory	See the "Measuring cables and sensor connection" section
No or slow change of readings	Sensor fouled	Clean sensor	See the "Cleaning pH/ORP electrodes" section
	Sensor old	Replace sensor	New sensor
	Sensor defective (reference lead)	Replace sensor	New sensor
	No internal buffer	Check KCl supply (0.8 bar above medium pressure).	KCl (CPY 4-x)
Measuring chain slope not adjustable/slope too small	Connection not at high impedance (moisture, dirt)	Check cable, plug connector and junction boxes	pH simulator, insulation, see the "Checking the connecting lines and boxes" section
	Device input defective	Check device directly	pH simulator
	Sensor old	Replace sensor	pH sensor
Measuring chain slope not	Hair-line crack in the glass membrane	Replace sensor	pH sensor

Error	Possible cause	Tests/remedial action	Tools, spare parts
adjustable/no slope	Connection not at high impedance (moisture, dirt)	Check cable, plug connector and junction boxes.	pH simulator, insulation, see the "Checking the connecting lines and boxes" section
Constant, incorrect measured value	Sensor does not immerse properly or protection cap not removed	Check installation position, remove protection cap.	
	Air pockets in assembly	Check assembly and orientation.	
	Grounding short at or in device	Perform test measurement in insulated vessel, with buffer solution if applicable.	Plastic vessel, buffer solutions
	Hair-line crack in the glass membrane	Replace sensor	pH sensor
	Device in impermissible operating condition (does not respond when key pressed)	Switch off device and switch it on again.	EMC problem: if this persists, check the grounding, shields and line routing or have checked by Endress+Hauser Service.
Wrong pH value in process	No/incorrect temperature compensation	ATC: activate function MTC: set process temperature.	
	Conductivity of medium too low	Select pH sensor with liquid KCl.	e.g. Ceraliquid CPS41
	Flow too high	Reduce flow or measure in a bypass	
	Potential in medium	Possibly ground with or at PM pin (connection PM/PE).	Problem mainly occurs in plastic lines.
	Sensor fouling or buildup on sensor	Clean the sensor (see the "Cleaning pH/ORP sensors" section)	For heavily contaminated media: Use spray cleaning
Incorrect temperature value	Incorrect sensor connection	Check connections using wiring diagram.	Wiring diagram in "Electrical connection" section
	Measuring cable defective	Check cable for interruptions/short-circuit/shunt.	Ohmmeter or local simulation
	Incorrect sensor type	Set type of temperature sensor at the device (field B1)	Glass electrode: Pt 100 ISFET: Pt 1000
Fluctuations in measured value	Interference on measuring cable	Connect cable shield as per wiring diagram	See the "Electrical connection" section
	Interference on signal output cable	Check cable routing, possibly route cable separately	Route signal output and measuring input lines separately
	Interference potential in medium	Measure symmetrically (with PML)	Possibly ground medium with PM/PE connection
	No potential matching (PA/PM) for symmetrical input	Connect PM pin in assembly to device PA/PM	
Controller or timer cannot be activated	No relay module available	Install LSR1-2 or LSR1-4 module	
Controller/limit contact does not work	Controller switched off	Activate controller	See fields R2xx
	Controller in operating mode "Manual off"	Select "Auto" or "Manual on" mode	Keyboard, REL key
	Pickup delay setting too long	Switch off or shorten pickup delay time	See fields R2xx

Error	Possible cause	Tests/remedial action	Tools, spare parts
	"Hold" function active "Hold" dwell period too long	"Auto hold" for calibration, "Hold" input activated; "Hold" active via keyboard	See fields S2 to S4
Controller/limit contact works continuously	Controller in operating mode "Manual on"	Select "Auto" or "Manual off" mode	Keyboard, REL and AUTO keys
	Dropout delay setting too long	Shorten dropout delay time	See fields R2xx
	Control loop interruption	Check measured value, current output value, actuators, chemical supply	
No current output signal	Cable disconnected or short-circuited	Disconnect cable and measure directly at device	mA meter 0–20 mA
	Output defective	See the "Device-specific errors" section	
Fixed current output signal	Current simulation active	Switch off simulation.	See field O2
	Impermissible operating state of processor system	Disconnect line voltage for approx. 10 seconds	Possibly EMC problem: if problem persists, check grounding and wire routing.
Incorrect current output signal	Incorrect current assignment	Check current assignment: 0–20 mA or 4–20 mA?	Field O2.11
	Total load in the current loop too high (> 500 Ω)	Disconnect output and measure directly at device	mA meter for 0–20 mA DC
Current output table is not accepted	Value interval too small	Select practical intervals	
No temperature output signal	Device does not have a second current output	Check version using nameplate, if necessary replace the LSCH-x1 module	LSCH-x2 module, see the "Spare parts" section
	Device with PROFIBUS-PA	PA device has no current output!	
Chemoclean function not available	No relay module (LSR1-x) installed or only LSR1-2 available Additional function not enabled	Install LSR1-4 module. Chemoclean is enabled using the release code supplied by the manufacturer in the Chemoclean retrofit kit. To check the version, see the nameplate	LSR1-4 module, see the "Spare parts" section
Plus Package functions not available	Plus Package not enabled (enable by entering a code which depends on the serial number and which is supplied by E+H when a Plus Package is ordered)	<ul style="list-style-type: none"> ■ For Plus Package retrofit: code is supplied by E+H → enter this code. ■ After replacing a defective LSCH/LSCP module: first enter device serial number manually (see nameplate), then enter the existing code number. 	For a detailed description, see the "Replacement of central module" section.
No HART or PROFIBUS communication	Several devices at the same address	Check addresses and re-enter if necessary	No communication possible if several devices set to the same address
No HART communication	No HART central module	Verify using nameplate: HART = -xxx5xx and -xxx6xx	Upgrade to LSCH-H1 / -H2
	No or incorrect DD (device description)	For further information, see BA00208C/07/EN, "HART field communication with Liquisys CxM223/253"	
	HART interface missing		
	Current output < 4 mA		

Error	Possible cause	Tests/remedial action	Tools, spare parts
	Load too small (must be > 230 Ω)		
	HART receiver (e.g. FXA 191) not connected via load but via power supply		
	Incorrect device address (addr. = 0 for single operation, addr. > 0 for multidrop operation)		
	Line capacitance too high		
	Interference on line		
	Several devices set to same address	Assign addresses correctly	No communication possible if several devices set to the same address
No PROFIBUS communication	No PA/DP central module	Verify using the nameplate: PA = -xxx3xx /DP = xxx4xx	Upgrade to LSCP module, see the "Spare parts" section
	Incorrect device software version (without PROFIBUS)	For further information, see BA00209C/07/EN "PROFIBUS PA/DP - Field communication for Liquisys CxM223/253".	Information about PROFIBUS configuration is provided in Technical Information TI00260F, while detailed information about instrumentation and accessories is provided in Operating Instructions BA00198F
	With Commuwin (CW) II: CW II version and device software version incompatible		
	No or incorrect DD/DLL		
	Incorrect baud rate setting for segment coupler in DPV-1 server		
	Bus user (master) has wrong address or address assigned twice		
	Bus user (slave) has wrong address		
	Bus line not terminated		
	Line problems (too long, cross-section too small, not shielded, shield not grounded, wires not twisted)		
	Bus voltage too low (Bus voltage typ. 24 V DC for non-Ex)		

8.4 Device-specific errors

The following table helps you during the diagnosis and points to any spare parts required. Depending on the degree of difficulty and the measuring equipment present, diagnosis is carried out by:

- Trained operator personnel
- The user's trained electrical technicians
- Company responsible for system installation/operation
- Endress+Hauser Service

Information on the exact spare part designations and on how to install these parts can be found in the "Spare parts" section.

Error	Possible cause	Tests/remedial action	Execution, tools, spare parts
Device cannot be operated, display value 9999	Operation locked	Press CAL and MINUS keys simultaneously.	See the "Key functions" section
Display dark, no light-emitting diode active	No line voltage	Check whether line voltage is present	Electrical technician / e.g. multimeter
	Supply voltage wrong/too low	Compare actual line voltage and nameplate data	User (data for energy supply company or multimeter)
	Connection faulty	<ul style="list-style-type: none"> ■ Terminal not tightened ■ Insulation jammed ■ Wrong terminals used 	Electrical technician
	Device fuse defective	Compare line voltage and the nameplate data and replace fuse	Electrical technician/suitable fuse; see exploded drawing in the the "Spare parts" section
	Power unit defective	Replace power unit, note version	Onsite diagnosis by Endress +Hauser Service, test module necessary
	Central module defective	Replace central module, note version	Onsite diagnosis by Endress +Hauser Service, test module necessary
Field device: ribbon cable loose or defective	Check ribbon cable, replace if necessary	See the "Spare parts" section	
Display dark, light-emitting diode active	Central module defective (module: LSCH/LSCP)	Replace central module, note version	Onsite diagnosis by Endress +Hauser Service, test module necessary
Values appear on display but: <ul style="list-style-type: none"> ■ Display does not change and / or ■ Device cannot be operated 	Device or module in device not correctly mounted	Panel-mounted device: reinstall insert. Field device: remount display module	Perform with the aid of the installation drawings in the the "Spare parts" section
	Impermissible operating system condition	Disconnect line voltage for approx. 10 seconds	Possibly Possible EMC problem: if this persists, check the installation or have checked by Endress+Hauser Service
Device gets hot	Voltage wrong/too high	Compare line voltage and nameplate data	User, electrical technician
	Power unit defective	Replace power unit	Diagnosis only by Endress +Hauser Service
pH/mV measured value and/or temperature measured value incorrect	Transmitter module defective (module: MKIC), please first carry out tests and take measures as per the "Process-specific errors" section	Measuring input test: <ul style="list-style-type: none"> ■ Connect pH, ref and PM directly at the device with wire jumpers = reading pH 7 ■ 100 Ω resistance at terminals 11/ 12 + 13 = display 0 °C 	If the test is negative: replace module (note version). Perform with the aid of the exploded drawings in the "Spare parts" section.
Current output, incorrect current value	Incorrect adjustment	Check with integrated current simulation, connect mA meter directly to current output.	If simulation value incorrect: adjustment in factory or new LSCH module required. If simulation value correct: check current loop for load and shunts.
	Load too large		
	Shunt / short to ground in current loop		
	Incorrect mode of operation	Check whether 0–20 mA or 4–20 mA is selected.	

Error	Possible cause	Tests/remedial action	Execution, tools, spare parts
No current output signal	Current output stage defective (only for LSCH module; LSCP has no current output)	Check with integrated current simulation, connect mA meter directly to current output	If test negative: Replace central module (note version)
Additional relays not working	Field device: ribbon cable loose or defective	Check ribbon cable seating, replace cable if required.	See the "Spare parts" section
Only 2 additional relays can be triggered	LSR1-2 relay module with 2 relays is installed	Upgrade to LSR1-4 with 4 relays.	User or Endress+Hauser Service
Additional functions (Plus Package) missing	No or incorrect release code used	If retrofitting: check whether the correct serial number was quoted when ordering the Plus Package.	Handled by Endress+Hauser Sales
	Incorrect device serial number saved in LSCH/ LSCP module	Check whether serial number on the nameplate matches SNR in LSCH/ LSCP (field S 8).	The serial number of the device is definitive for the Plus Package.
Additional functions (Plus Package and/or Chemoclean) missing after LSCH/LSCP module replacement	Replacement modules LSCH or LSCP have the device serial number 0000 when they leave the factory. The Plus Package or Chemoclean are not enabled on leaving the factory.	In the case of LSCH/LSCP with SNR 0000, a device serial number can be entered once in fields E115 to E117. Then enter the release codes for the Plus Package and/or Chemoclean if necessary.	For a detailed description, see the "Replacement of central module" section.
No HART or PROFIBUS PA/DP interface function	Incorrect central module	HART: LSCH-H1 or H2 module, PROFIBUS-PA: LSCP-PA module, PROFIBUS-DP: LSCP-DP module, see field E112.	Replace central module; User or Endress+Hauser Service.
	Wrong software	SW version, see field E111.	
	Bus problem	Remove some devices and repeat the test.	Contact Endress+Hauser Service.

9 Maintenance

WARNING

Process pressure and temperature, contamination, electrical voltage

Risk of serious or fatal injury

- ▶ If the sensor has to be removed during maintenance work, avoid hazards posed by pressure, temperature and contamination.
- ▶ Make sure the device is de-energized before you open it.
- ▶ Power can be supplied to switching contacts from separate circuits. De-energize these circuits before working on the terminals.

Take all the necessary precautions in time to ensure the operational safety and reliability of the entire measuring point.

The maintenance of the measuring point comprises:

- Calibration
- Cleaning the controller, assembly and sensor
- Checking the cables and connections

When performing any work on the device, bear in mind any potential impact this may have on the process control system or on the process itself.

NOTICE**Electrostatic discharge (ESD)**

Risk of damaging the electronic components

- ▶ Take personal protective measures to avoid ESD, such as discharging beforehand at PE or permanent grounding with a wrist strap.
- ▶ For your own safety, only use genuine spare parts. With genuine parts, the function, accuracy and reliability are also ensured after maintenance work.

9.1 Maintenance of the entire measuring point

9.1.1 Cleaning the transmitter

Clean the front of the housing using commercially available cleaning agents only.

The front of the housing is resistant to the following in accordance with DIN 42 115:

- Ethanol (for a short time)
- Diluted acids (max. 2% HCl)
- Diluted alkaline solutions (max. 3% NaOH)
- Soap-based household cleaning agents

When performing any work on the device, bear in mind any potential impact this may have on the process control system or on the process itself.

NOTICE**Prohibited cleaning agents**

Damage to the housing surface or housing seal

- ▶ Never use concentrated mineral acids or alkaline solutions for cleaning.
- ▶ Never use organic cleaners such as benzyl alcohol, methanol, methylene chloride, xylene or concentrated glycerol cleaner.
- ▶ Never use high-pressure steam for cleaning purposes.

9.1.2 Cleaning the pH/ORP electrodes

⚠ CAUTION**Cleaning not switched off during calibration or maintenance activities**

Risk of injury due to medium or cleaning agent

- ▶ If a cleaning system is connected, switch it off before removing a sensor from the medium.
- ▶ If you wish to check the cleaning function and have therefore not switched off the cleaning system, please wear protective clothing, goggles and gloves or take other appropriate measures.

⚠ CAUTION**Risk of injury from cleaning agents**

- ▶ When using the following cleaning agents, make sure to protect your hands, eyes and clothing.

Please clean **contamination on the glass electrodes** as follows:

- Oily and greasy films:
Clean with hot water or temperature-controller detergent (grease remover, e.g. alcohol, acetone, possibly dishwashing detergent).
- Lime and metal hydroxide buildup:
Dissolve buildup with diluted hydrochloric acid (3 %) and then rinse thoroughly with plenty of clear water.
- Sulfidic buildup (from flue gas desulfurization or sewage treatment plants):
Use a mixture of hydrochloric acid (3 %) and thiocarbamide (commercially available) and then rinse thoroughly with plenty of clear water.

- Buildup containing proteins (e.g. food industry):
Use a mixture of hydrochloric acid (0.5 %) and pepsin (commercially available) and then rinse thoroughly with plenty of clear water.
- Fibers, suspended substances:
Pressurized water, surface-active agents if necessary
- Light biological buildup:
Pressurized water

ORP electrodes:

Carefully clean the metal pins or surfaces mechanically.

-  After mechanical cleaning, the ORP sensor can require several hours conditioning time. For this reason, check the calibration after one day.

ISFET sensors

- Never use acetone to clean ISFET sensors as this could damage the material.
- After being cleaned with compressed air, ISFET sensors require approx. 5 to 8 minutes until the closed-control loop is re-established and the measured value has adjusted to the real value.

Clogged membranes can be cleaned mechanically under certain circumstances (does not apply to ISFET sensors, Teflon membranes and open ring junction electrodes):

- Use a small warding file.
- Only file in one direction.

Air bubbles in the electrode:

- Air bubbles can indicate incorrect mounting. For this reason check the orientation.
- The range 15° to 165° to the horizontal is allowed (ISFET sensors are the exception).
- Not permitted: horizontal installation or installation with the plug-in head pointing downwards.

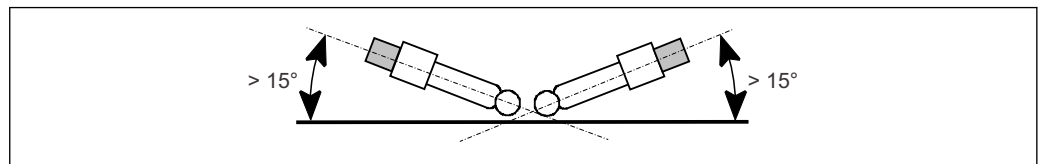

 46 Permitted angle of installation for glass electrodes

A0027183

Check for reference system reduction

The inner reference lead of the reference system (Ag/AgCl) of a combination electrode or a separate reference electrode is usually brownish and matt. A silver-colored reference system is reduced and therefore defective. This is caused by a current flowing through the reference element.

Possible causes for the current flow:

- Incorrect measuring device operating mode selected (PML pin connected, but operating mode asymmetrical ("without PML"). See also the function description for "Selecting the connection type".
- Shunt in measuring cable (e.g. due to moisture) between reference line and grounded shield or PM line.
- Measuring device defective (shunt in reference input or entire input amplifier downstream of PE).

9.1.3 Maintenance of digital sensors

1. If an error occurs or the maintenance schedule stipulates that the sensor has to be replaced, use a new sensor, or a sensor that has been precalibrated in the laboratory. A sensor is calibrated in the laboratory under optimum external conditions, thereby ensuring better quality of measurement.

2. Remove the sensor to be serviced and install the new sensor.
3. You must perform calibration if you use a sensor that is not precalibrated.
4. The sensor data are automatically accepted by the transmitter. A release code is not required.
5. Measurement is resumed.
6. Take the used sensor back to the laboratory. In the laboratory you can get the sensor ready for reuse while ensuring the availability of the measuring point.

Regenerating digital sensors:

1. Clean the sensor. For this purpose, use the cleaning agent specified in the sensor manual.
2. Inspect the sensor for cracks or other damage.
3. If no damage is found, regenerate the sensor. Where necessary, store the sensor in a regeneration solution (--> sensor manual).
4. Recalibrate the sensor for reuse.

9.1.4 Liquid KCl supply

- The KCl must be free of bubbles. In the case of an unpressurized version, check whether the cotton thread is present in the hose.
- In the case of counterpressure, check whether the pressure in the KCl tank is min. 0.8 bar (12 psi) above the medium pressure.
- The KCl consumption should be low but noticeable. Approx. 1 to 10 ml/day is typical.
- The opening for sensors with a KCl top-up opening at the glass shaft must be clear.

9.1.5 Assembly

Refer to the assembly operating manual for information on servicing and troubleshooting the assembly. The assembly operating manual describes the procedure for mounting and disassembling the assembly, replacing the sensors and seals, and contains information on the material resistance properties, as well as on spare parts and accessories.

9.1.6 Connecting cables and junction boxes

Check the cables and connections for moisture. Moisture is indicated by a sensor slope that is too small. If nothing more can be displayed or if the display is fixed at pH 7, please check the following components:

- Sensor head
- Sensor plug
- Junction box, if fitted
- Extension cable

NOTICE

Incorrect measurements caused by moisture in the measuring cable

- ▶ If there is moisture in the measuring cable, the cable must be replaced!

A shunt in the cable of $> 20 \text{ M}\Omega$ cannot be measured with normal multimeters but is damaging for the pH measurement. Connect a pH simulator instead of the sensor. The value that is displayed on the transmitter must match the value set at the simulator. The value can differ at the second decimal place at the very maximum.

If you do not have a pH simulator, you can test the cable with a commercially available megohmmeter. Please note the following when performing the test:

- Make sure to disconnect the pH measuring cable from the sensor and device!
- If you are using a junction box, you should check the infeed and outfeed measuring cable separately.
- Check the cable with 1000 V DC (at least with 500 V DC) testing voltage.
- If the cable is intact, the insulation resistance is $> 100 \text{ G}\Omega$.
- If the cable is defective (moist), there is flashover.
The cable must be replaced.



You can clean (desalinate) the sensor head and junction box with de-ionized water and dry them with a hot air dryer.

10 Repair

10.1 Spare parts

Please order spare parts from your local Sales Office. For this purpose, use the order numbers listed in the "Spare part kits" section.

For safety, you should always provide the following additional data when ordering spare parts:

- Device order code
- Serial number
- Software version, if possible

You can take the order code and serial number from the nameplate.

The software version is provided in the device software provided that the device processor system is still working.

For more detailed information on spare parts kits, please refer to the "Spare Part Finding Tool" on the Internet:

www.endress.com/spareparts_consumables

10.2 Disassembling the panel-mounted device



Please note the effects on the process if the device is taken out of service!

See the exploded drawing for the item numbers.

1. Disconnect the terminal block (item 422 b) from the rear of the device to de-energize the device.
2. Then disconnect the terminal blocks (item 422 a and 430 where applicable) from the rear of the device. Now you can disassemble the device.
3. Press in the latches of the end frame (item 340) and remove the frame from the rear.
4. Release the special screw (item 400) by turning it counter-clockwise.
5. Remove the entire electronics block from the housing. The modules are only mechanically connected and can be easily separated:
6. Simply remove the processor/display module towards the front.
7. Pull out the brackets of the rear plate (item 320) slightly.
8. Now you can remove the side modules.
9. Remove the pH/mV transmitter (item 230) as follows:
10. Bend the shielding plate up.
11. Disconnect the connected strand (pH input, strand comes from the BNC connection jack).
12. Using a fine wire cutter, nip off the heads of the synthetic distance holders.
13. Then remove the module from above.

Assembly is the reverse of the disassembly sequence. Tighten the special screw finger-tight without using a tool.

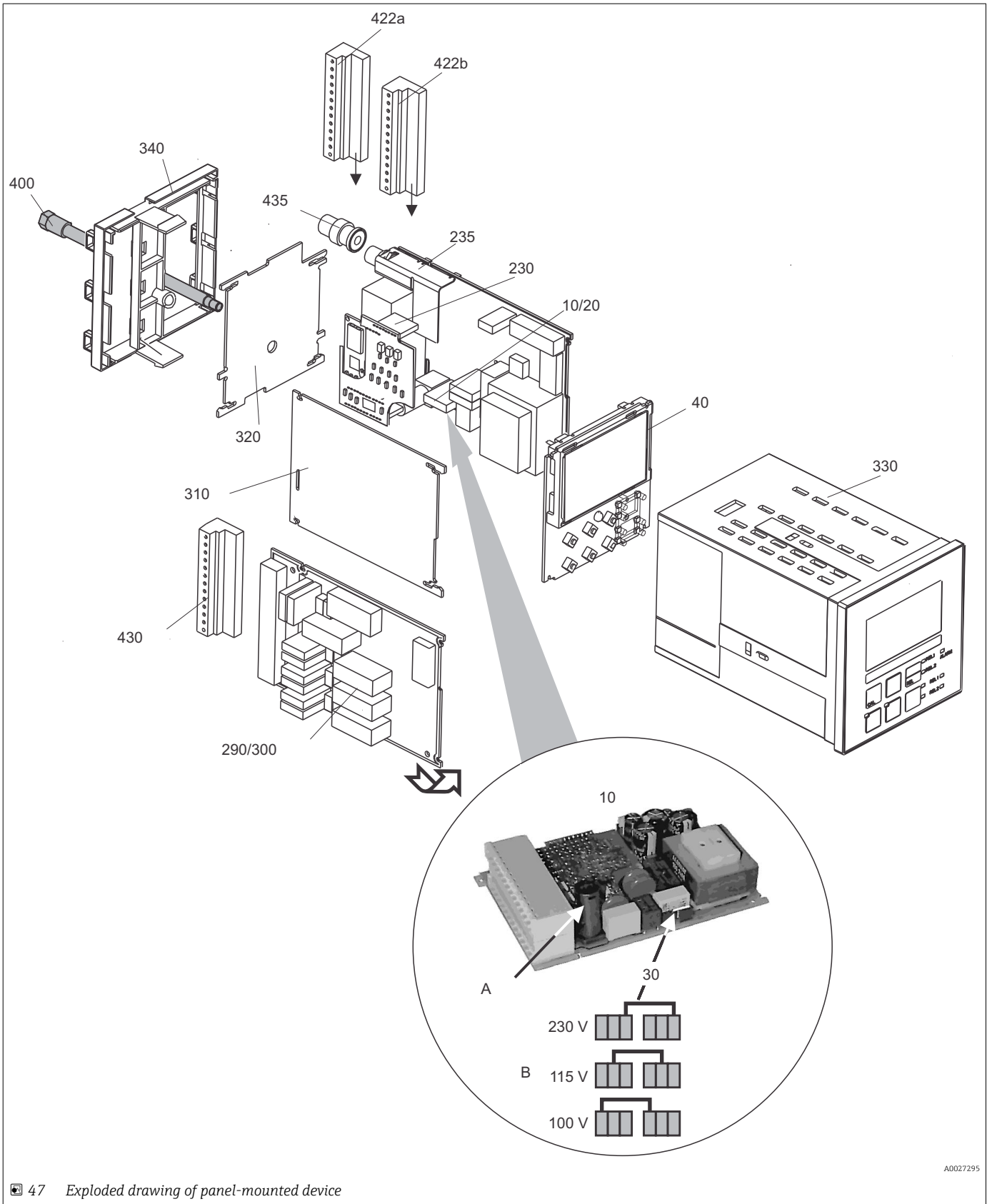

47 Exploded drawing of panel-mounted device

A0027295

The exploded drawing contains the components and spare parts of the panel-mounted device. You can take the spare parts and the corresponding order number from the following section using the item numbers.

Item	Kit description	Name	Function/contents	Order no.
10	Power unit	LSGA	100/115/230 V AC	51500317
20	Power unit	LSGD	24 V AC + DC	51500318
30	Jumper		Part of power unit, item 10	
40	Central module	LSCH-S1	1 current output	51501081
40	Central module	LSCH-S2	2 current outputs	51501082
40	Central module	LSCH-H1	1 current output + HART	51501083
40	Central module	LSCH-H2	2 current outputs + HART	51501084
40	Central module	LSCP	PROFIBUS PA/no current output	51501085
40	Central module	LSCP	PROFIBUS DP/no current output	51502503
40	Kit for CPM2x3 central module PROFIBUS DP	LSCP-DP	PROFIBUS DP central module Relay module + 2 relays Curr. input + DP terminals Hardware version 2.10 and higher	71134724
230	pH/mV transmitter	MKP1	pH/mV + temperature input Glass electrode	51501080
230	pH/mV transmitter	MKP2	pH/mV + temperature input ISFET sensor	51507096
230	pH/mV transmitter	MKP3	pH/mV + temperature input, glass electrode ab Software-Version 2.55 HART, bzw. 2.33 PROFIBUS	51518244
230	Memosens transmitter	MKD1	Digital input	51514966
235	pH/mV input		BNC connection jack + shielding plate	51501070
290	Relay module	LSR1-2	2 relays	51500320
290	Relay module	LSR2-2i	2 relays + 4-20 mA current input	51504304
290	Kit for CxM2x3 relay module PROFIBUS DP	LSR2-DP	Relay module + 2 relays Current inp. + DP terminals Hardware version 2.10 and higher	71134732
300	Relay module	LSR1-4	4 relays	51500321
300	Relay module	LSR2-4i	4 relays + 4-20 mA current input	51504305
310	Side panel		Kit with 10 parts	51502124
310, 320, 340, 400	Housing mechanical parts		Rear plate, side panel, end frame, special screw	51501076
330, 400	Housing module		Housing with front membrane, sensory tappets, seal, special screw, tensioning dogs, connection plates and nameplates	51501075
340	End frame		Rear frame for PROFIBUS DP, with D-submin plug connector	51502513
for 340	PE terminal		PE terminal for shield grounding for IS version	51501086
422a, 422b	Terminal strip set		Complete standard terminal strip set + HART	51501077
422a, 422b	Terminal strip set		Complete terminal strip set PROFIBUS PA	51502125
422a, 422b	Terminal strip set		Complete terminal strip set PROFIBUS DP	51502494
430	Terminal strip		Terminal strip for relay module	51501078

Item	Kit description	Name	Function/contents	Order no.
435	BNC connector		BNC easy solder-free, angled	50074961
A	Fuse		Part of power unit, item 10	
B	Choice of line voltage		Position of jumper on power unit, item 10 depending on line voltage	

10.3 Disassembling the field device

 Please note the effects on the process if the device is taken out of service!

See the exploded drawing for the item numbers.

You require the following tools to disassemble the field device:

- Standard set of screwdrivers
- Torx screwdriver, size TX 20

Proceed as follows to disassemble the field device:

1. Open and remove the cover of the connection compartment (item 420).
2. Disconnect the supply terminal (item 470) to de-energize the device.
- 3.
4. Open the display cover (item 410) and release the ribbon cable (item 310 / 320) on the electronics box side (item 330).
5. To remove the central module (item 40) release the screw in the display cover (item 450 b).
6. Proceed as follows to remove the electronics box (item 330):
7. Turn the screws in the housing base (item 450 a) by two revolutions to release them.
8. Then push the entire box backwards and remove it from above while making sure that the module locks do not open.
9. Bend the module locks out and remove the modules.
10. To remove the docking module (item 340) remove the screws in the housing base (item 450 c) and remove the entire assembly from above.
11. To remove the pH/mV transmitter (item 230) bend the shielding plate up.
12. Disconnect the connected strand (pH input, strand comes from the BNC connection jack) and nip off the heads of the synthetic distance sleeves using a fine wire cutter.
13. Then remove the module from above.

To assemble, carefully push the modules into the guide rails of the electronics box and let them engage in the side box noses.

 It is not possible to mount the modules incorrectly. Modules inserted in the electronics box incorrectly are not operable since the ribbon cables cannot be connected.

Make sure the cover seals are intact to guarantee IP 65 ingress protection.

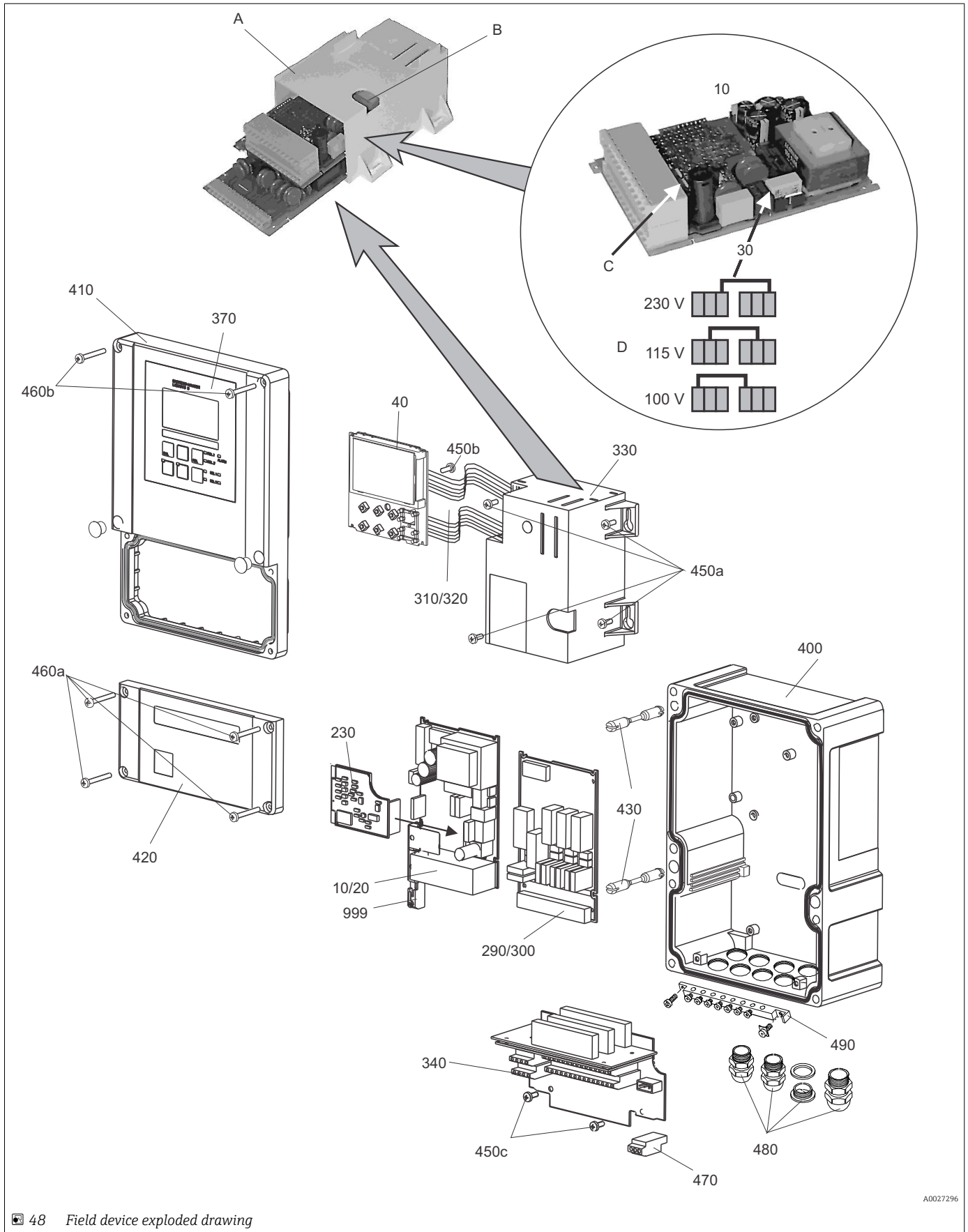

48 Field device exploded drawing

A0027296

The exploded drawing contains the components and spare parts of the field device. You can take the spare parts and the corresponding order number from the following section using the item numbers.

Item	Kit description	Name	Function/contents	Order no.
10	Power unit	LSGA	100/115/230 V AC	51500317
20	Power unit	LSGD	24 V AC + DC	51500318
30	Jumper		Part of power unit, item 10	
40	Central module	LSCH-S1	1 current output	51501081
40	Central module	LSCH-S2	2 current outputs	51501082
40	Central module	LSCH-H1	1 current output + HART	51501083
40	Central module	LSCH-H2	2 current outputs + HART	51501084
40	Central module	LSCP	PROFIBUS PA/no current output	51501085
40	Central module	LSCP	PROFIBUS DP/no current output	51502503
40	Kit for CPM2x3 central module PROFIBUS DP	LSCP-DP	PROFIBUS DP central module Relay module + 2 relays Curr. input + DP terminals Hardware version 2.10 and higher	71134724
230	pH/mV transmitter	MKP1	pH/mV + temperature input Glass electrode	51501080
230	pH/mV transmitter	MKP2	pH/mV + temperature input ISFET sensor	51507096
230	pH/mV transmitter	MKP3	pH/mV + temperature input, glass electrode ab Software-Version 2.55 HART, bzw. 2.33 PROFIBUS	51518244
230	Memosens transmitter	MKD1	Digital input	51514966
290	Relay module	LSR1-2	2 relays	51500320
290	Relay module	LSR2-2i	2 relays + 4-20 mA current input	51504304
290	Kit for CxM2x3 relay module PROFIBUS DP	LSR2-DP	Relay module + 2 relays Current inp. + DP terminals Hardware version 2.10 and higher	71134732
300	Relay module	LSR1-4	4 relays	51500321
300	Relay module	LSR2-4i	4 relays + 4-20 mA current input	51504305
310, 320	Ribbon cable lines		2 ribbon cable lines	51501074
340, 330, 450	Inner housing fittings		Docking module, empty electronics box, small parts	51501073
450a, 450c	Torx screws K4x10		Part of inner housing fittings	
450b	Torx screw for central module		Part of inner housing fittings	
410, 420, 370, 430, 460	Housing cover		Display cover, connection compartment cover, front membrane, hinges, cover screws, small parts	51501068
460a, 460b	Cover screws		Part of housing cover	
430	Hinges		2 pairs of hinges	51501069
400, 480	Housing base		Base, threaded joints	51501072
470	Terminal strip		Terminal strip for connection to power supply	51501079
490	PE rail		PE connection rail for shield grounding for IS version	51501087

Item	Kit description	Name	Function/contents	Order no.
999	pH/mV terminal module		ph/mV terminal + shielding plate	51501071
A	Electronics box with relay module LSR1-x (bottom) and power unit LSGA/LSGD (top)			
B	Fuse also accessible if electronics box installed			
C	Fuse		Part of power unit, item 10	
D	Choice of line voltage		Position of jumper item 30 on power unit item 10 depending on line voltage	

10.4 Replacing the central module

i Generally, when a central module has been replaced, all data which can be changed are set to the factory setting.

If possible, note the customized settings of the device, such as:

- Calibration data
- Current assignment, main parameter and temperature
- Relay function selections
- Limit value/controller settings
- Cleaning settings
- Monitoring functions
- Interface parameters

Proceed as described below if a central module is replaced:

1. Disassemble the device as explained in the "Dismantling the panel-mounted instrument" or "Dismantling the field instrument" section.
2. Use the part number on the central module to check whether the new module has the same part number as the previous module.
3. Reassemble the device with the new module.
4. Put the device back into operation and check the basic functions (e.g. measured value and temperature display, operation via keyboard).
5. Read the serial number ("ser-no.") off the nameplate of the device (e.g. 6A345605G00) and enter this number in fields E115 (1st digit = year, one-digit (6 in the example)), E116 (2nd digit: month, one-digit (A in the example)), E117 (digits 3-6 cons. number, four-digit (3456 in the example)).
 - ↳ In the field E118, the complete number is displayed again so you can check it is correct.

i You can only enter the serial number for new modules with the serial number 0000. This can only be done once! For this reason, make sure the number entered is correct before you press ENTER to confirm!

If an incorrect code is entered, the additional functions are not enabled. An incorrect serial number can only be corrected at the factory!

1. Press ENTER to confirm the serial number or cancel the entry to enter the number again.
2. If available, enter the release codes for the Plus Package and/or Chemoclean in the "Service" menu.
3. Check the Plus Package release (e.g. by opening the function group CHECK / Code P) or the Chemoclean function.
4. Make the customized device settings again.

10.5 Return

The product must be returned if repairs or a factory calibration are required, or if the wrong product was ordered or delivered. As an ISO-certified company and also due to legal regulations, Endress+Hauser is obliged to follow certain procedures when handling any returned products that have been in contact with medium.

To ensure swift, safe and professional device returns, please read the return procedures and conditions at www.endress.com/support/return-material.

10.6 Disposal

The device contains electronic components and must therefore be disposed of in accordance with regulations on the disposal of electronic waste.

Observe the local regulations.

11 Accessories

11.1 Sensors

11.1.1 pH glass electrodes

Orbisint CPS11D/ CPS11

- pH electrode for process technology
- Optional SIL version for connecting to SIL transmitter
- With dirt-repellent PTFE diaphragm
- Product Configurator on the product page: www.endress.com/cps11d or www.endress.com/cps11



Technical Information TI00028C

Ceraliquid CPS41D/ CPS41

- pH electrode with ceramic junction and KCl liquid electrolyte
- Product Configurator on the product page: www.endress.com/cps41d or www.endress.com/cps41



Technical Information TI00079C

Ceragel CPS71D/ CPS71

- pH electrode with double-chamber reference system and integrated bridge electrolyte
- Product Configurator on the product page: www.endress.com/cps71d or www.endress.com/cps71



Technical Information TI00245C

Orbipore CPS91D/ CPS91

- pH electrode with open aperture for media with high dirt load
- Product Configurator on the product page: www.endress.com/cps91d or www.endress.com/cps91



Technical Information TI00375C

Orbipac CPF81D/ CPF81

- Compact pH sensor for installation or immersion operation
- In industrial water and wastewater
- Product Configurator on the product page: www.endress.com/cpf81d or www.endress.com/cpf81
- Product Configurator on the product page: www.endress.com/cpf81d



Technical Information TI00191C

11.1.2 pH ISFET sensors

Tophit CPS441D/ CPS441

- Sterilizable ISFET sensor for low-conductivity media
- Liquid KCl electrolyte
- Product Configurator on the product page: www.endress.com/cps441d or www.endress.com/cps441



Technical Information TI00352C

Tophit CPS471D/ CPS471

- Sterilizable and autoclavable ISFET sensor for food and pharmaceuticals, process engineering
- Water treatment and biotechnology
- Product Configurator on the product page: www.endress.com/cps471d or www.endress.com/cps471



Technical Information TI00283C

Tophit CPS491D/ CPS491

- ISFET sensor with open aperture for media with high dirt load
- Product Configurator on the product page: www.endress.com/cps491d or www.endress.com/cps491



Technical Information TI00377C

11.1.3 ORP sensors**Orbisint CPS12D/ CPS12**

- ORP sensor for process technology
- Product Configurator on the product page: www.endress.com/cps12d or www.endress.com/cps12



Technical Information TI00367C

Ceraliquid CPS42D/ CPS42

- ORP electrode with ceramic junction and KCl liquid electrolyte
- Product Configurator on the product page: www.endress.com/cps42d or www.endress.com/cps42



Technical Information TI00373C

Ceragel CPS72D/ CPS72

- ORP electrode with double-chamber reference system and integrated bridge electrolyte
- Product Configurator on the product page: www.endress.com/cps72d or www.endress.com/cps72



Technical Information TI00374C

Orbipore CPS92D/ CPS92

- ORP electrode with open aperture for media with high dirt load
- Product Configurator on the product page: www.endress.com/cps92d or www.endress.com/cps92



Technical Information TI00435C

Orbipac CPF82D/ CPF82

- Compact ORP sensor for installation or immersion operation in process water and wastewater
- Product Configurator on the product page: www.endress.com/cpf82d or www.endress.com/cpf82
- Product Configurator on the product page: www.endress.com/cpf82d



Technical Information TI00191C

11.1.4 Sensor simulators

Memocheck Plus CYP01D / Memocheck CYP02D / Memocheck Sim CYP03D

- Testing tools for analysis measuring points
- Simple, fast and reliable sensor simulation
- Product Configurator on the product page:
 - www.endress.com/cyp01d
 - www.endress.com/cyp02d
 - www.endress.com/cyp03d



Technical Information TI00481C

11.2 Connection accessories

CPK9

For pH/ORP electrodes with TOP68 plug-in head

CPK1

For pH/ORP electrodes with GSA plug-in head

CPK2

For pH/ORP electrodes with GSA plug-in head, with three electrode connectors

CPK12

For pH glass electrodes and ISFET sensors with TOP68 plug-in head



Ordering information is available from your sales office or at www.endress.com.

CYK10 Memosens data cable

- For digital sensors with Memosens technology
- Product Configurator on the product page: www.endress.com/cyk10



Technical Information TI00118C

Measuring cable CYK81

- Unterminated cable for extending sensor cables (e.g. Memosens, CUS31/CUS41)
- 2 x 2 cores, twisted with shielding and PVC sheath (2 x 2 x 0.5 mm² + shielding)
- Sold by meter, Order No.: 51502543

VBM

- Junction box for cable extension
- 10 terminal strips
- Cable entries: 2 x Pg 13.5 or 2 x NPT ½"
- Material: aluminum
- Degree of protection: IP 65
- Order numbers
 - Cable entries Pg 13.5 : 50003987
 - Cable entries NPT ½": 51500177

VBA

- Junction box for cable extension
- 10 terminal strips
- Cable entries: 2 x Pg 13.5, 2 x Pg 16
- Material: polycarbonate
- Degree of protection: IP 65
- Order number: 50005276

11.3 Installation accessories

CYY101

- Weather protection cover for field devices
- Absolutely essential for field installation
- Material: stainless steel 1.4301 (AISI 304)
- Order No. CYY101-A

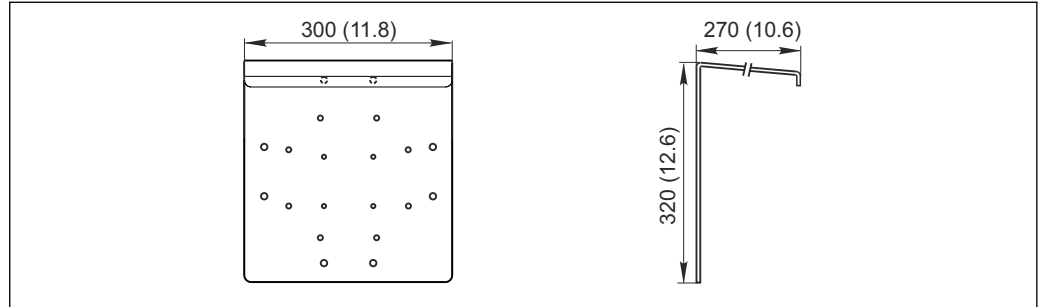

A0024627

49 Dimensions in mm (inch)

Flexdip CYH112

- Modular holder system for sensors and assemblies in open basins, channels and tanks
- For Flexdip CYA112 water and wastewater assemblies
- Can be affixed anywhere: on the ground, on the capstone, on the wall or directly onto railings.
- Stainless steel version
- Product Configurator on the product page: www.endress.com/cyh112

 Technical Information TI00430C

Post mounting kit

- For securing the field housing to horizontal and vertical posts and pipes
- Material: stainless steel 1.4301 (AISI 304)
- Order No. 50086842

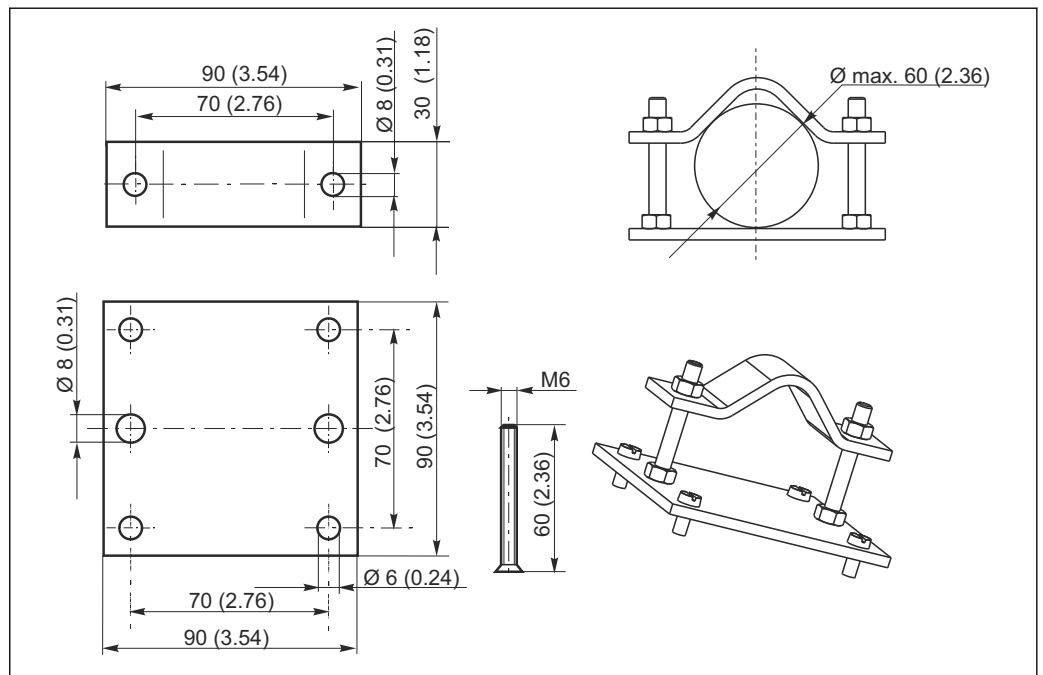

A0024660

50 Dimensions in mm (inch)

11.4 Software and hardware add-ons

The add-ons can only be ordered by quoting the serial number of the device in question.

- Plus Package
Order No. 51500385
- Chemoclean function (requires four-relay card)
Order No. 51500963
- Two-relay card
Order No. 51500320
- Four-relay card
Order No. 51500321
- Two-relay card with current input
Order No. 51504304
- Four-relay card with current input
Order No. 51504305

11.5 Buffer solutions

High-quality buffer solutions from Endress+Hauser - CPY20

The secondary buffer solutions have been referenced to primary reference material of the PTB (German Federal Physico-technical Institute) and to standard reference material of NIST (National Institute of Standards and Technology) according to DIN 19266 by a DKD (German Calibration Service) accredited laboratory.

Product Configurator on the product page: www.endress.com/cpy20

Technical buffer solutions for ORP electrodes

- +220 mV, pH 7, 250 ml; order no. CPY3-4
- +468 mV, pH 0.1, 250 ml; order no. CPY3-5

KCl electrolyte solutions for topping up liquid-filled pH/ORP electrodes

- 3.0 mol, T = -10 to 100 °C, 100 ml, Order No. CPY4-1
- 3.0 mol, T = -10 to 100 °C, 1000 ml, Order No. CPY4-2
- 1.5 mol, T = -30 to 100 °C, 100 ml, Order No. CPY4-3
- 1.5 mol, T = -30 to 100 °C, 1000 ml, Order No. CPY4-4

12 Technical data

12.1 Input

Measured variables	pH value ORP Temperature	
Measuring range	pH	0 to 14
	ORP	-1500 to +1500 mV / 0 to 100 %
	Temperature	
	Pt 100	-50 to +150 °C (-60 to +300 °F)
	Pt 1000 (CPM2x3-IS)	-50 to +150 °C (-60 to +300 °F)
	NTC 30K (CPM2x3-IS)	-20 to +100 °C (0 to +212 °F)
Input impedance	> 10 ¹² Ω (under rated operating conditions) for standard sensors	
Binary inputs	Voltage	10 to 50 V
	Current consumption	Max. 10 mA
Current input	4 to 20 mA, galvanically isolated Load: 260 Ω for 20 mA (voltage drop 5.2 V)	

12.2 Output

Output signal	HART	
	Signal encoding	Frequency Shift Keying (FSK) + 0.5 mA via current output signal
	Data transmission rate	1200 baud
	Galvanic isolation	Yes
	PROFIBUS PA	
	Signal encoding	Manchester Bus Powered (MBP)
	Data transmission rate	31.25 kBit/s, voltage mode
	Galvanic isolation	Yes (IO modules)
	PROFIBUS DP	
	Signal encoding	RS485
	Data transmission rate	9.6 kBd, 19.2 kBd, 93.75 kBd, 187.5 kBd, 500 kBd, 1.5 MBd
	Galvanic isolation	Yes (IO modules)
Signal on alarm	2.4 or 22 mA in the event of an error	

Load	Max. 500 Ω	
Transmission range	pH ORP Absolute Relative Temperature	Configurable, min. Δ 1 pH Configurable, min. Δ 50 mV Fixed, 0 to 100 % Configurable, Δ 10 to Δ 100 % of end of measuring range
Signal resolution	Max. 700 digits/mA	
Minimum turndown of output signal	10 % of the measuring range span	
Separation voltage	Max. 350 V _{RMS} / 500 V DC	
Auxiliary voltage output	Output voltage Output current	15 V \pm 0.6 V Max. 10 mA
Contact outputs	Switching current with ohmic load ($\cos \varphi = 1$) Switching current with inductive load ($\cos \varphi = 0.4$) Switching voltage Switching power with ohmic load ($\cos \varphi = 1$) Switching power with inductive load ($\cos \varphi = 0.4$)	Max. 2 A Max. 2 A Max. 250 V AC, 30 V DC Max. 500 VA AC, 60 W DC Max. 500 VA AC, 60 W DC
Limit contactors	Pickup/dropout delay	0 to 2000 s
Controller	Function (configurable) Controller behavior Control gain K_p Integral action time T_n Derivative action time T_v Period length for pulse length controller Frequency for pulse frequency controller Basic load	Pulse length/pulse frequency controller, continuous controller P, PI, PD, PID, basic load dosing 0.01 to 20.00 0.0 to 999.9 min 0.0 to 999.9 min 0.5 to 999.9 s 60 to 180 min ⁻¹ 0 to 40 % of max. actuating variable
Alarm	Function (switchable) Alarm threshold adjustment range Alarm delay Monitoring time for lower limit violation Monitoring time for upper limit violation	Latching/momentary contact pH/temperature: entire measuring range 0 to 2000 s 0 to 2000 min 0 to 2000 min

Protocol-specific data

HART	
Manufacturer ID	11 _h
Device type	0091 _h
Transmitter-specific revision	0001 _h
HART version	5.0
Device description files (DD)	www.endress.com/hart
HART load (communication resistor)	250 Ω
Device variables	None (only dynamic variables PV and SV)
Supported features	-

PROFIBUS PA	
Manufacturer ID	11 _h
Device type	1516 _h
Device revision	0001 _h
Profile version	2.0
GSD files	www.endress.com/profibus
GSD version	
Output values	Primary value, temperature
Input variables	PCS display value
Supported features	Device lock: The device can be locked using the hardware or software.

PROFIBUS DP	
Manufacturer ID	11 _h
Device type	1520 _h
Profile version	2.0
GSD files	www.endress.com/profibus
GSD version	
Output values	Primary value, temperature
Input variables	PCS display value
Supported features	Device lock: The device can be locked using the hardware or software.

12.3 Power supply

Supply voltage
 Depending on order version:
 ■ 100/115/230 V AC +10/-15 %, 48 to 62 Hz
 ■ 24 V AC/DC +20/-15 %

Power supply via fieldbus	HART	
	Supply voltage	Not applicable, active current outputs
	Reverse polarity protection	Not applicable, active current outputs

PROFIBUS PA	
Supply voltage	9 V to 32 V, max. 35 V
Sensitivity to reverse polarity	No
FISCO/FNICO compliant according to IEC 60079-27	No

PROFIBUS DP	
Supply voltage	9 V to 32 V, max. 35 V
Sensitivity to reverse polarity	Not applicable
FISCO/FNICO compliant according to IEC 60079-27	No

Power consumption Max. 7.5 VA

Mains fuse Fine-wire fuse, semi-delay 250 V/3.15 A

Circuit breaker **NOTICE**
The device does not have a power switch
 ► The customer must provide a protected circuit breaker in the vicinity of the device.
 ► The circuit breaker must be a switch or power switch, and you must label it as the circuit breaker for the device.
 ► At the supply point, the power supply for the 24 V versions must be isolated from dangerous live cables by double or reinforced insulation.

Cable specification	Cable length Memosens	Max. 100 m (330 ft)
	Cable length analog sensors	Max. 50 m (160 ft)

Overvoltage protection According to EN 61000-4-5

12.4 Performance characteristics

Reference operating conditions	Reference temperature:	25 °C (77 °F)
Measured value resolution	pH value	0.01 pH
	ORP	1 mV/0.1 %
	Temperature	0.1 °C
Maximum measured error	Display	
	pH	Max. 0.5 % of measuring range
	ORP	Max. 0.5 % of measuring range
	Temperature	Max. 1.0 % of measuring range
	Signal output	
	pH	Max. 0.75 % of measuring range
	ORP	Max. 0.75 % of measuring range
	Temperature	Max. 1.25 % of measuring range
	 Measured errors in accordance with DIN IEC 746 Part 1, at rated operating conditions	
Repeatability	Max. 0.2 % of measuring range	
Zero point shift	Glass electrode	pH 5.0 to 9.0 (nominal pH 7.00)
	Antimony electrode	pH -1.0 to 3.0 (nominal pH 1.00)
	ISFET sensor	-500 to +500 mV
Slope adjustment	Glass electrode	38.00 to 65.00 mV/pH (nominal 59.16 mV/ pH)
	Antimony electrode	25.00 to 65.00 mV/pH (nominal 59.16 mV/ pH)
	ISFET sensor	38.00 to 65.00 mV/pH (nominal 59.16 mV/ pH)
Offset	pH	±2 pH units
	ORP	±120 mV/±50 %
	Temperature	±5 °C for adjusting the temperature display

12.5 Environment

Ambient temperature range	-10 to +55 °C (+10 to +130 °F)	
Storage temperature	-25 to +65 °C (-10 to +150 °F)	
Electromagnetic compatibility	Interference emission and interference immunity as per EN 61326-1:2006, EN 61326-2-3:2006	

Degree of protection	Field device Panel-mounted device	IP 65 / integrity according to NEMA 4X IP 54 (front), IP 30 (housing)
Electrical safety	As per EN/IEC 61010-1:2010, overvoltage category II for installations up to 2000 m (6500 ft) above MSL	
CSA	Device versions with CSA General Purpose approval are certified for indoor use.	
Relative humidity	10 to 95%, not condensing	
Degree of contamination	The product is suitable for pollution degree 2.	

12.6 Mechanical construction

Dimensions	Panel-mounted device	L x B x D: 96 x 96 x 145 mm (3.78" x 3.78" x 5.71") Installation depth: approx. 165 mm (6.50")
	Field device	L x B x D: 247 x 170 x 115 mm (9.72" x 6.69" x 4.53")
Weight	Panel-mounted device	Max. 0.7 kg (1.54 lbs.)
	Field device	Max. 2.3 kg (5.07 lbs.)
Materials	Panel-mounted device housing	Polycarbonate
	Field housing	ABS PC FR
	Front membrane	Polyester, UV-resistant
Terminals	Cable cross-section	Max. 2.5 mm ² (14 AWG)

13 Appendix

Function group OFFSET V	Entry of absolute value current measured value -2.00...16 pH -1500...1500 mV 0.0...100.0 % V1	Current offset is displayed 0.00 pH , -2.00...2.00 pH 0 mV , -120...120 mV 0.0 % , -50.0...50.0 % V2	Calibration status is displayed o.k. E-- V3	Store offset results yes; no; new V4		
Function group NUMERIC CALIBRATION N	Enter reference temperature 25.0 °C -20.0...150.0 °C N1	Enter slope Glass 59.16 mV/pH 38.00...65.00 mV/pH Antimon 59.18 mV/pH 25.00...65.00 pH ISFET 59.16 mV/pH 38.00...65.00 mV/pH N2	Enter zero point Glass 7.00 pH 5.00...9.00 pH Antimon 1.00 pH -1.00...3.00 pH ISFET 0 mV -500...+500 V N3	Calibration status is displayed o.k. E-- N4	Store calibration results yes; no; new N5	
Function group CALIBRATION Redox % calibration Redox mV calibration pH calibration (displayed calibration type options depend on selection in A1)	Calibration of 80% value (toxic sample) -1500...1500 mV C31	Calibration Acceptance when stable at $\leq \pm 5$ mV for more than 5 s C32	Calibration of 20% value (non-toxic sample) -1500...1500 mV C33	Calibration Acceptance when stable at $\leq \pm 5$ mV for more than 5 s C34	Calibration status is displayed o.k. E-- C35	Store calibration results yes; no; new C36
	Enter value of redox buffer current measured value -1500 mV ... 1500 mV C21	Calibration Acceptance when stable $\leq \pm 1$ mV for more than 5 s C22	Zero point is displayed -100...100 mV C23	Calibration status is displayed o.k. E-- C24	Store calibration results yes; no; new C25	
	Enter calibration temperature (if B3 = MTC) 25.0 °C -20.0...150.0 °C C11	Enter pH value of first buffer solution Buffer value of last calibration; 0.00...14.00 pH C12	Calibration Acceptance when stable at $\leq \pm 0.05$ pH for more than 10 s C13	Enter pH value of the second buffer solution Buffer value of last calibration 0.00 pH...14.00 pH C14	Calibration Acceptance when stable at $\leq \pm 0.05$ pH for more than 10 s C15	Display of slope Glass 59.16 mV/pH 38.00...65.00 mV/pH Antimon 59.16 mV/pH 25.00...65.00 mV/pH ISFET 59.16 mV/pH 38.00...65.00 mV/pH C16
CAL Edit mode Call Z1 Read mode any code	MEAS. VALUE DISPLAY with TEMPERATURE DISPLAY in °C + - E Edit mode Call Z1 Read mode any code	Temperature display in °F Temperature display suppressed Measured value display in mV Measured value display Current input in % Measured value display Current input in mA	1st error is displayed (if present) Other errors are displayed (up to 10 errors)			
Function group SETUP 1 A	Select operating mode pH, ORP (mV); ORP (%) A1	Select connection type sym = symmetrical asym = asymmetrical A2	Enter measured value damping 1 (no damping) 1-60 A3	Select sensor Glass ($E_s = 7.0$) Antimon = Antimon ISFET A4	Select temperature sensor Pt 100 Pt 1k NTC 30K A5	
Function group SETUP 2 B	Select temperature compensation (for the process) pH: ATC; MTC Redox: on off B1	Enter MTC temperature (if B1=MTC and A1=pH) 25.0 °C -50.0 ... +150.0 °C B2	Select temperature compensation (for the calibration) ATC; MTC B3	Enter correct process temperature (if B1=ATC) 25.0 °C -50.0 °C ... +150.0 °C B4	Display of temperature difference (Offset) 0.0 °C -5.0...5.0 °C B5	
Function group CURRENT INPUT Z	Controller switch-off by current input Off; input Z1	Delay of controller switch-off by current input 0 s 0 ... 2000 s Z2	Delay of controller switch-on by current input 0 s 0 ... 2000 s Z3	Switch-off limit value for current input 50% 0 ... 100% Z4	Switch-off direction for current input Low; high Z5	Feedforward control to PID controller Off; lin = linear Z6
	Select characteristic Tab = table O3 (3) sim = simulation O3 (2)	Select table options read; edit O331	Enter number of value pairs in table 1 1...10 O332	Select table value pair 1 1... number of table value pairs; assign O333		
	Select current output Out 1; Out 2 O1	Select measured variable for 2nd current output °C; pH, mV, Contr O2	Select current range lin = linear O3 (1) 4-20 mA, 0-20 mA O311	Enter 0/4 mA value +2.00 pH; -2.00...16.00 pH 1500 mV; -1500...1500 mV 0.0%; 0.0...100.0 % 0.0°C; -50...150.0 °C O312	Enter 20 mA value 12.00 pH; -2.00...16.00 pH 1500 mV; -1500...1500 mV 100.0%; 0.0...100 % 100.0°C; -50...150.0 °C O313	
Function group ALARM F	Select contact type Latch = latching contact; Momen = momentary cont. F1	Select alarm delay unit s; min F2	Alarm delay 0 s (min) 0 s... 2000 s (min) (depends on F2) F3	Set error current 22 mA; 2,4 mA F4	Select error number 1 1... 255 F5	Set alarm contact to be effective yes; no F6

Zero point is displayed Glass 7.00 pH 5.00...9.00 pH Antimony: 1.00 pH -1.00...3.00 pH ISFET current value -500...+500 mV	Calibration status is displayed o.k. E--	Store calibration results yes; no; new
C17	C18	C19

Feedforward control = 1 at 50% 0 ... 100%
Z7

Enter x value (measured value) 0.00 pH ; -2.00...16.00 pH 0 mV; -1500...1500 mV 0.0 %; 0.0...100.0 %
O334

Enter y value (current value) 0.00 mA 0.00...20.00 mA
O335

Table status o.k. yes; no
O336

Activate error current for previously set error no; yes
F7

Automatic start of cleaning function no; yes (not always displayed see error messages)
F8

Select "next error" or return to menu next = next error; ←R
F9

Field for customer
settings

Function group CHECK P	SCS alarm Measuring sensor off, on P1	SCS alarm Reference sensor (if A2=sym) off, on P2	SCS alarm threshold 50 kΩ 1.5...50 kΩ P3	Leakage current is displayed (ISFET sensors only) 0.0 ... 9.9 mA P4	Select process monitoring Off; Low; High; LoHi; Lo; Hi; LoHi! P5	Alarm delay 0 min (s) 0 ... 2000 min (s) P6			
	Function group RELAY R	Select contact to be configured Rel1; Rel2; Rel3; Rel4; R1	Limit contactor configuration Neutr = neutralisation controller (with Rel1 and Rel2 and A1 = pH only) R2 (6)	Function R2 (6) switch off or on off, on R261	Set point 1 (or 2) 6.00 pH -2.00...16.00 pH R262	Enter control gain Kp1 (or Kp2) 1.00 0.01...20.00 R263	Enter integral action time Tn (0.0 = no I component) 0.0 min 0.0...999.9 min R264		
			Clean = Chemoclean (with Rel3 only) R2 (5)	Function R2 (5) switch off or on off, on R251	Select start pulse int = internal; ext = external; i+ext = internal + external; i+stp = internal, suppressed by ext R252	Enter pre-rinse time 30 s 0...999 s R253	Enter cleaning time 10 s 0...999 s R254		
			Timer R2 (4)	Function R2 (4) switch off or on off, on R241	Set rinse time 30 s 0...999 s R242	Set pause time 360 min 1...7200 min R243	Set minimum pause time 120 min 1...3600 min R244		
			PID controller R2 (3)	Function R2 (3) switch off or on off, on; basic; PID+B R231	Enter set point pH 16.00; -2.00...16.00 pH 1500 mV; -1500...1500 mV 100.0 %; 0...100.0 % R232	Enter control gain Kp 1.00 0.01...20.00 R233	Enter integral action time Tn (0.0 = no I component) 0.0 min 0.0...999.9 min R234		
			LC °C = Limit contactor T R2 (2)	Function R2 (2) switch off or on off, on R221	Enter switch-on temperature 150.0 °C -50.0...+150.0°C R222	Enter switch-off temperature 150.0 °C -50.0...+150.0°C R223	Enter pick-up delay 0 s 0...2000 s R224		
			Function group SERVICE S	Select language ENG; GER ITA; FRA ESP; NEL S1	LC PV = Limit contactor pH/Redox R2 (1)	Function R2 (1) switch off or on off, on R211	Select contact switch-on point 16.00 pH; -2.00...16.00 pH 1500 mV; -1500...1500 mV 100.0 %; 0...100.0 % R212	Select contact switch-off point pH 16.00; pH -2.00...16.00 1500 mV; -1500...1500 mV 100.0 %; 0...100.0 % R213	Enter pick-up delay 0 s 0...2000 s R214
					Hold configuration s+c during setup and calibration CAL=during calibration Setup=during setup none=no hold S2	Manual hold off, on S3	Enter hold dwell period 10 s 0...999 s S4	Enter release code for SW upgrade (Plus package) 0000 0000...9999 S5	Enter release code for SW upgrade ChemoClean 0000 0000...9999 S6
					Select module Sens = sensor E1(5)	Software version SW version E151	Hardware version HW version E152	Serial number is displayed E153	Module name is displayed E154
					Rel = relay E1(4)	Software version SW version E141	Hardware version HW version E142	Serial number is displayed E143	Module name is displayed E144
MainB = mainboard E1(3)	Software version SW version E131	Hardware version HW version E132			Serial number is displayed E133	Module name is displayed E134			
Trans = transmitter E1(2)	Software version SW version E121	Hardware version HW version E122			Serial number is displayed E123	Module name is displayed E124			
Function group E + H SERVICE E	Contr = controller E1(1)	Software version SW version E111	Hardware version HW version E112	Serial number is displayed E113	Module name is displayed E114				
		Function group INTERFACE I	Enter address HART: 0...15 or PROFIBUS 1...126 I1	Tag is displayed @@@@@@@@ I2					

A0027500-EN

Set lower alarm threshold pH -2.00 pH -2 ... 16 P7	Set upper alarm threshold pH 16.00 pH -2 ... 16 P8	Select process monitoring Off, AC, CC; AC CC ACI; CC; ACCG! P9	Set max. perm. period of lower limit exceeded 60 min 0 ... 2000 min P10	Set max. perm. period of upper limit exceeded 120 min 0 ... 2000 min P11	Set monitoring value pH 1.00 pH -2... 16 P12		
Enter derivative action time Tv (0.0 = no D component) 0.0 min 0.0...999.9 min R265	Select len = pulse length freq = pulse frequency curr = current output 2 R266	Enter pulse interval 10.0 s 0.5...999.9 s R267	Enter maximum pulse frequency 120 1/min 60...180 1/min R268	Enter minimum ON time t _{on} 0.3 s 0.1...5.0 s R269	Enter process type Batch Inline R2610		
Enter post-rinse time 20 s 0...999 s R255	Set number of repeat cycles 0 0...5 R256	Set interval between two cleaning cycles (pause time) 360 min 1...7200 min R257	Enter minimum pause time 120 min 1...R357 min R258	Enter number of cleaning cycles without cleaning agent 0 0...9 R259			
Enter derivative action time Tv (0.0 = no D component) 0.0 min 0.0...999.9 min R235	Select control characteristic dir = direct; inv = inverted; R236	Select len = pulse length freq = pulse frequency curr = current output 2 R237	Enter pulse interval 10.0 s 0.5...999.9 s R238	Enter maximum pulse frequency 120 1/min 60...180 1/min R239	Enter minimum ON time t _{on} 0.3 s 0.1...5.0 s R2310	Enter basic load 0% 0 ... 40% R2311	Enter process type Batch Inline R2312
Enter dropout delay 0 s 0...2000 s R225	Enter alarm threshold (as an absolute value) 150.0 °C -20.0...+150.0 °C R226	LC status is displayed MAX MIN R227					
Enter dropout delay 0 s 0...2000 s R215	Enter alarm threshold (as an absolute value) 16.00 pH; -2.00...16.00 pH 1500 mV; -1500...1500 mV 100.0 %; 0...100.0 % R216	LC status is displayed MAX MIN R217					
Order number is displayed S7	Serial number is displayed S8	Reset instrument to default values no; Sens = sensor data; Facyt = factory settings. S9	Perform instrument test no; display S10	Reference voltage is displayed S11	Select AC frequency S12		

A0027501-EN

Index

A

Access codes	36
Accessories	106
Alarm	53
Alarm contact	30
Approvals	10
Automatic mode	35

B

Buffer solutions	110
----------------------------	-----

C

Calibration	77
Central module replacement	104
Certificates	10
Check	54
Cleaning	
Sensors	94
Transmitter	94
Commissioning	38
Digital electrodes	38
ISFET sensors	38
Communication	76
Connecting cables	96
Current input	45
Current outputs	49

D

Designated use	7
Device configuration	43
Device-specific errors	91
Diagnostics	84
Digital sensors	
Maintenance	95
Disassembling	
Field device	101
Panel-mounted device	98
Display	31
Disposal	105

E

E+H Service	75
Electrical connection	18
Environment	115

F

Feedforward control	46
-------------------------------	----

H

Hold function	37
-------------------------	----

I

Incoming acceptance	9
Input	111
Installation	11
Installation conditions	13
Installation instructions	15

Interfaces	76
----------------------	----

J

Junction boxes	96
--------------------------	----

K

Key functions	33
-------------------------	----

L

Liquid KCl supply	96
Local operation	35

M

Maintenance	93
Assembly	96
Digital sensors	95
Maintenance of the entire measuring point	94
Manual mode	35
Measuring system	12
Mechanical construction	116
Menu structure	37

N

Nameplate	10
Neutralization controller	64
Numeric calibration	82

O

Offset	82
Operating concept	36
Operating elements	33
Operating modes	36
Operation	31
Output	111

P

P(ID) controller	60
Performance characteristics	115
Post mounting	15
Post-connection check	30
Post-installation check	17
Power supply	114
Process-specific errors	88
Product identification	9

Q

Quick Setup	41
-----------------------	----

R

Relay configuration	58
Repair	98
Replacing the central module	104
Return	105

S

Safety instructions	7
Scope of delivery	9

Sensor connection	
With Memosens	28
Without Memosens	21
Service	73
Setup 1	43
Setup 2	45
Spare parts	98
Switching on	39
Symbols	5
System error messages	84
T	
Technical data	111
Trouble shooting instructions	84
Troubleshooting	84
U	
Use	7
W	
Wall mounting	15
Warnings	5
Wiring	18
Wiring diagram	
With Memosens	25
Without Memosens	18



www.addresses.endress.com
