

Signet 2537 Paddlewheel Flowmeter



3-2537.090 Rev. 11 03/19

Operating Instructions



Description

The 2537 Paddlewheel Flowmeter Series offer low flow, low power and high resolution with various output options such as a Volumetric Pulse, Pulse Divider, Flow Switch, Digital (S³L), or 4 to 20 mA. This unit can be configured on-site directly through the built-in user interface.

- The 4 to 20 mA model provides a blind current loop output.
- The Digital (S³L) model provides a Digital (S³L) output for use with the Signet 8900 Multi-Parameter Controller or 9900 Transmitter.
- The Multi model uses a single relay (mechanical or solid state) and has three selectable operating modes:
 - Divider Mode scales the paddlewheel frequency down to accommodate low frequency input devices.
 - Total Mode outputs one pulse per a set volume of fluid.
 - Flow Switch Mode uses a single relay for Hi or Lo alarm operation.

A small LCD enables the 2537 to be programmed without any external equipment. During normal operation the display is not visible.

Table of Contents

Warranty Statement.....	2
Product Registration	2
Safety Information.....	2
Chemical Compatibility	2
Specifications.....	3
Location of Fitting	4
Sensor Mounting Position.....	4
Pipe Fittings.....	4
Dimensions.....	5
Installation.....	5
Wiring.....	5
Digital (S ³ L) Output Wiring.....	6
4 to 20 mA Output Wiring.....	6
Flow Switch Output (On-Off).....	7
Pulse Output	7
Dry Contact Relay Wiring.....	7
Solid State Relay Wiring	7
Operation	8
Menus	8
View Mode Function	9
Menu Details	9
Set Flow Units.....	10
Set 4 and Set 20	10
Set K-Factor.....	10
Set Contrast	10
Averaging and Sensitivity.....	11
Set Averaging.....	11
Set Sensitivity	11
Multi Mode	12
P-Factor	12
Set Relay Operation.....	13
K-Factor	14-15
H-Dimension	15
Maintenance and Cleaning	15
Rotor Replacement Procedure	15
Ordering Information.....	16



- [English](#)
- [Deutsch](#)
- [Français](#)
- [Español](#)
- [Italiano](#)
- [中文](#)



For earlier versions of this sensor, the Rev. C version of the 2537 manual is available at www.gfsignet.com, under **Resource Center**.

Select **Sensors and Instrumentation**, click **Archived Products**, select 2537, click **Instruction Manuals**.

Warranty Information

Refer to your local Georg Fischer Sales office for the most current warranty statement.

All warranty and non-warranty repairs being returned must include a fully completed Service Form and goods must be returned to your local GF Sales office or distributor. Product returned without a Service Form may not be warranty replaced or repaired.

Signet products with limited shelf-life (e.g. pH, ORP, chlorine electrodes, calibration solutions; e.g. pH buffers, turbidity standards or other solutions) are warranted out of box but not warranted against any damage, due to process or application failures (e.g. high temperature, chemical poisoning, dry-out) or mishandling (e.g. broken glass, damaged membrane, freezing and/or extreme temperatures).

Product Registration







Thank you for purchasing the Signet line of Georg Fischer measurement products.

If you would like to register your product(s), you can now register online in one of the following ways:

- Visit our website www.gfsignet.com. Under **Service and Support** click on **Product Registration Form**
- If this is a pdf manual (digital copy), [click here](#)

Safety Information

1. Depressurize and vent system prior to installation or removal.
2. Confirm chemical compatibility before use.
3. DO NOT exceed maximum temperature or pressure specs.
4. ALWAYS wear safety goggles or faceshield during installation and/or service.
5. DO NOT alter product construction.
6. If this equipment is used in a manner not specified by the manufacturer, the protection provided by the equipment may be impaired
7. **This device is not approved for use or installation in hazardous locations.**

	Caution / Warning / Danger Indicates a potential hazard. Failure to follow all warnings may lead to equipment damage, injury, or death
	Personal Protective Equipment (PPE) Always utilize the most appropriate PPE during installation and service of Signet products.
	Pressurized System Warning Sensor may be under pressure, take caution to vent system prior to installation or removal. Failure to do so may result in equipment damage and/or serious injury.
	Hand Tighten Only Overtightening may permanently damage product threads and lead to failure of the retaining nut.
	Do Not Use Tools Use of tool(s) may damage product beyond repair and potentially void product warranty.
	Note / Technical Notes Highlights additional information or detailed procedure.

Chemical Compatibility

Georg Fischer Signet products are manufactured in a variety of wetted materials to suit various liquids and chemicals.

All plastic materials including typical piping types (PVC, PVDF, PP and PE) are more or less permeable to contained media, such as water or volatile substances, including some acids. This effect is not related to porosity, but purely a matter of gas diffusion through the plastic.

If the plastic material is compatible with the medium according to the application guidelines, the permeation will not damage the plastic itself. However, if the plastic encloses other sensitive components, as is the case with GF Signet plastic paddlewheel sensors, these may be affected or damaged by the media diffusing through the plastic body and rotor.

Failures of PVDF paddlewheel sensors when used in hot nitric acid applications have been reported. PVDF is known to allow for substantial permeation of nitric acid constituents without being damaged itself. No clear guideline can be given here, since the damaging effect to the sensor is highly dependent on temperature, pressure and concentration.

Utilizing sensors in applications with aggressive substances is possible. On special request GF Signet can provide sensors with a different internal resin encapsulation (potting) that will delay the damaging effect of acids to the sensors.

For all Special Product inquiries or to place an order, please email signet-specialproduct@georgfischer.com.



WARNING!



Paddlewheel Retaining Nuts:

The retaining nuts of paddlewheel sensors are not designed for prolonged contact with aggressive substances. Strong acids, caustic substances and solvents or their vapor may lead to failure of the retaining nut, ejection of the sensor and loss of the process fluid with possibly serious consequences, such as damage to equipment and serious personal injury. Retaining nuts that may have been in contact with such substances, e.g. due to leakage or spilling, must be replaced.

Paddlewheel Maintenance:

Paddlewheel flow sensors are subject to wear and may require maintenance and replacement of mechanical parts (rotors, pin, O-rings, bearings, retainers, etc.). The frequency of recommended maintenance will vary based upon application specifications, characteristics of the measured fluid, and installation details. These can include, but are not limited to: process flowrate, occurrence of water hammer, fluid corrosiveness and abrasiveness, sensor installation relevant to other equipment.

GF Signet offers individual replacement parts and rotor replacement kits, which include replacement instructions, allowing customers to perform field maintenance and reduce application down-time. Please refer to the Paddlewheel Replacement section (page 15) or contact your local GF Sales Representative with any questions.

515, 2536, 8510, 8512, 2537 Only:

To support our customers, the GF Signet Repair Department offers services to recertify the plastic paddlewheel products to factory specification. Contact your distributor or visit www.gfsignet.com for more information.

Specifications

General

Flow Rate Range	0.1 m/s to 6 m/s (0.3 ft/s to 20 ft/s)
Pipe Size Range	DN15 to DN200 (½ in. to 8 in.)
Min. Reynolds Number	4500
Wiring Ports	½ in. NPT threads; liquid-tight connector accepts cables 7 mm to 10 mm OD (0.275 in. to 0.394 in.)

Materials

Case	PBT, Yellow
Inside Cover	Valox, Black

Wetted Materials

-P0, -P1

Sensor Body	Glass Filled Polypropylene
O-Rings	FKM
Pin	Titanium
Rotor	PVDF, Black; optional ETFE with or without carbon fiber reinforced PTFE sleeve for rotor pin

-T0

Sensor Body	PVDF, Natural
O-Rings	FKM
Pin	PVDF, Natural
Rotor	PVDF, Natural; optional ETFE with or without carbon fiber reinforced PTFE sleeve for rotor pin

Performance

Input Frequency Range	1 to 1000 Hz
System Response	100 ms update rate nominal
Paddlewheel Frequency	49 Hz per m/s nominal (15 Hz per ft/s nominal)
Linearity	±1% of maximum range @ 25 °C (77 °F)
Repeatability	±0.5% maximum range @ 25 °C (77 °F)

Electrical

Relay Specifications

Dry Contact SPDT	5 A @ 30 VDC, 5 A @ 250 VAC
Solid-State Relay	100 mA @ 40 VDC, 70 mA @ 33 VAC

Power Requirements

Multi:	
with Dry-Contact Relay	24 VDC nominal ±10%, regulated, 30 mA max. current
with Solid-State Relay	5 to 24 VDC nominal ±10%, regulated, 30 mA max. current
Digital (S ³ L)	5.0 VDC min. to 6.5 VDC max., 30 mA max. current (1.5 mA nominal)
4 to 20 mA	400 mV max. ripple voltage, 30 mA max. current

Reverse Polarity and

Short Circuit Protected	Up to 40 V, 1 hour
Over-Voltage Protection	> 40 VDC over 1 hour

Output

Signal Averaging	Programmable 0 to 100 seconds
Sensitivity Response	Programmable 0 to 9 scale

Pulse Divider/Total Pulse Output

Pulse Divider Setting	1.0000 to 99999
Maximum pulse rate	300 Hz
Maximum pulse width	50 ms

Flow Switch Output

Relay Modes	Low, High
Time Delay	0.0 to 6400.0 seconds
Hysteresis	Adjustable in Engineering Units

Digital (S³L) output

Type	Serial ASCII, TTL level 9600 bps
Maximum Cable Length	Application dependent (See 8900 manual)

Current output (Passive 4 to 20 mA)

Loop Accuracy	±32 µA (@ 25 °C @ 24 VDC)
Loop Resolution	5 µA
Temp. Drift	±1 µA per °C max.
Power Supply Rejection	±1 µA per V
Maximum Cable Length	305 m (1,000 ft)
Max. Loop Resistance	600 Ω @ 24 VDC, 1 KΩ @ 32 VDC

Environmental Requirements

Enclosure Rating	NEMA 4X/IP65
Storage Temperature	-10 °C to 75 °C (14 °F to 167 °F)
Ambient Temperature	0 °C to 65 °C (32 °F to 150 °F)
Relative Humidity	0 to 90% RH, non-condensing
Altitude	2000 m (6,562 ft)
Pollution Degree	2

Pressure/Temperature Ratings

Polypropylene Body

- 12.5 bar (180 psi) max. @ 20 °C (68 °F)
- 1.7 bar (25 psi) max. @ 85 °C (185 °F)

PVDF Body

- 14 bar (200 psi) max. @ 20 °C (68 °F)
- 1.7 bar (25 psi) max. @ 85 °C (185 °F)

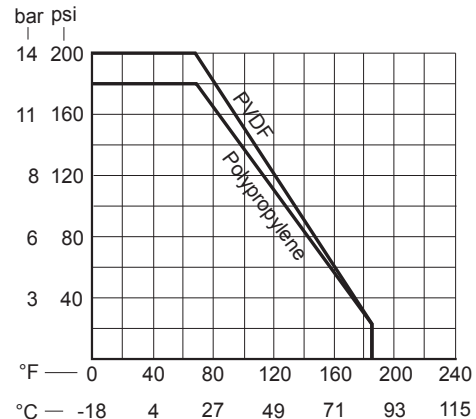

Intended Use

This product is intended for use in industrial water treatment and wastewater treatment applications where the chemical content and the fluid temperatures are consistent with the specifications listed herein.

This device is not approved for use or installation in flammable liquids.

Standards and Approvals

- CE, UL
- NSF (3-2537-xC-Px versions only)
- China RoHS (Go to www.gfsignet.com for details)
- Manufactured under ISO 9001 for Quality, ISO 14001 for Environmental Management and OHSAS 18001 for Occupational Health and Safety.

FC Declaration of Conformity according to FCC Part 15

This device complies with Part 15 of the FCC rules. Operation is subject to the following two conditions:
 (1) This device may not cause harmful interference, and
 (2) This device must accept any interference received, including interference that may cause undesired operation.

Location of Fitting

Recommended sensor upstream/downstream mounting requirements:

Select a location with sufficient length of straight pipe immediately upstream of the sensor.

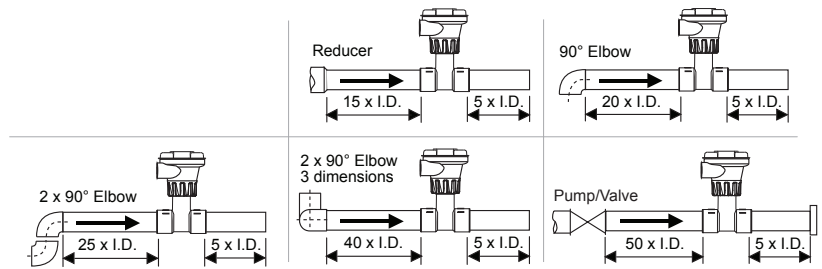

Locating the sensor in a trap or where the flow is upward helps to protect the sensor from exposure to air bubbles when the system is in operation.

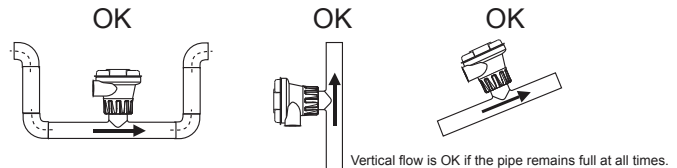

These configurations are not recommended because it is difficult to keep the pipe full.

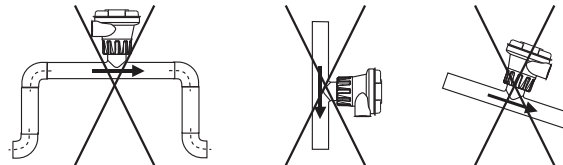

Sensor Mounting Position

Horizontal pipe runs:

Mount sensor in the upright (0°) position for best performance. Mount at a maximum of 45° when air bubbles are present (pipe must be full).

Do not mount on the bottom of the pipe when sediments are present.



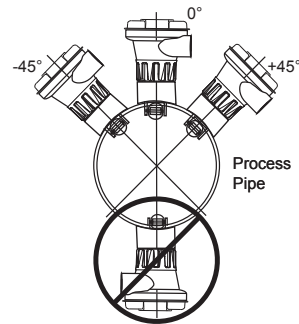

Vertical pipe runs:



Mount sensor in any orientation; however, downward flow is not recommended. Upward flow is preferred to ensure full pipe.



Pipe Fittings

Georg Fischer Signet offers a wide selection of installation fittings that control the position of the paddlewheel in relation to the dimensions of the pipe.

Type	Description
Plastic tees 	<ul style="list-style-type: none"> 0.5 to 2 inch versions (MPVC or CPVC) 2.5 to 4 inch versions (PVC)
PVC Glue-on Saddles 	<ul style="list-style-type: none"> Available in 10 and 12 inch sizes only Cut 2-1/2 inch hole in pipe Weld in place using solvent cement
PVC Saddles 	<ul style="list-style-type: none"> 2 to 4 inch, cut 1-7/16 inch hole in pipe 6 to 8 inch, cut 2-1/8 inch hole in pipe
Iron Strap-on saddles 	<ul style="list-style-type: none"> 2 to 4 inch, cut 1-7/16 inch hole in pipe Over 4 inch, cut 2-1/8 inch hole in pipe Special order 14 in. to 36 in.
Metric Wafer Fitting 	<ul style="list-style-type: none"> For pipes DN65 to 200 mm PP or PVDF

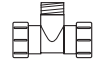
Type	Description
Iron, Carbon Steel, 316 SS Threaded tees 	<ul style="list-style-type: none"> 0.5 to 2 in. versions Mounts on threaded pipe ends
Carbon steel & stainless steel Weld-on Weldolets 	<ul style="list-style-type: none"> 2 to 4 inch, cut 1-7/16 inch hole in pipe Over 4 inch, cut 2-1/8 inch hole in pipe
Fiberglass tees FPT 	<ul style="list-style-type: none"> 1.5 in. to 2 in. PVDF insert
Metric Union Fitting 	<ul style="list-style-type: none"> For pipes from DN 15 to 50 mm PP or PVDF

Dimensions

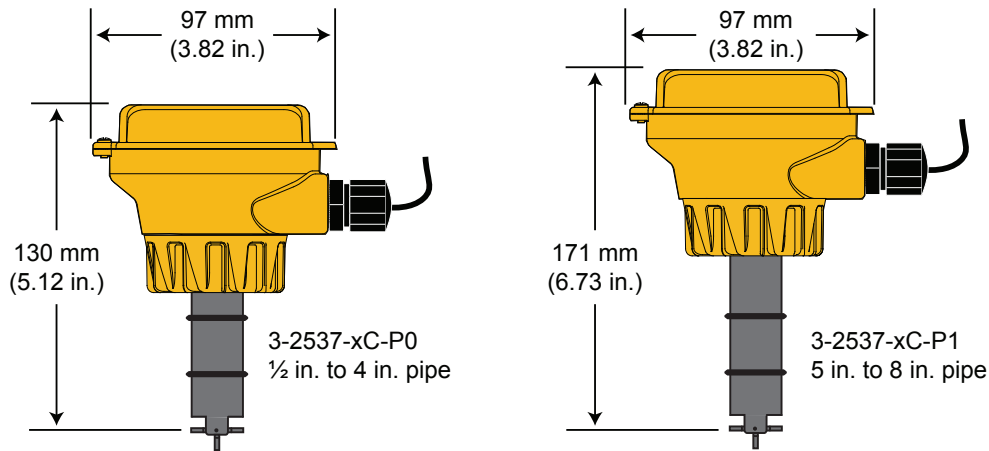

Installation

Plastic sensor installation tips

- Inspect the sensor O-rings for nicks and other damage that may compromise the seal.
- Lubricate O-rings with a non-petroleum based, viscous lubricant (grease) compatible with the system.
- Using an alternating/twisting motion, lower the sensor into the fitting, making sure the conduit ports on the yellow housing are pointing in the direction of flow.
- Engage one thread of the sensor cap then turn the sensor until the alignment tab is seated in the fitting notch.



HAND-TIGHTEN THE THREADED NUT ONTO THE INSTALLATION FITTING. DO NOT USE TOOLS!



DO NOT USE THREAD SEALANT OR LUBRICANTS ON THE FITTING THREADS OR THE SENSOR CAP.

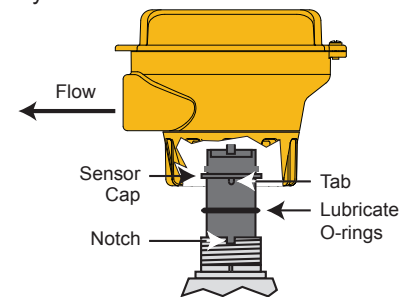

Wiring

Electrical connections to this product should be made only by qualified personnel.

To access the wiring terminals:

1. Turn yellow cap ¼ turn counterclockwise to remove.
2. Remove the two retaining screws and remove the black cover.
 - Route all cables through the conduit ports before connecting them to the terminals.
 - Wiring terminals are rated for 16 to 22 AWG conductors.
 - The cable must be 7 mm to 10 mm in diameter (0.275 in. to 0.394 in.) to seal properly in the liquid tight connector.
3. The conduit ports have ½ inch NPT threads. After routing the cables, seal the port with a liquid tight conduit connector (3-9000.392-1) or with conduit.
 - For conduit installations:
 - Thread conduit with ½ in. NPT threads directly into the conduit port.
 - For conduit with ISO threads, use the black thread adapter included with the connector kit.
 - To comply with NEC requirements, do not use any metal conduit in the installation.

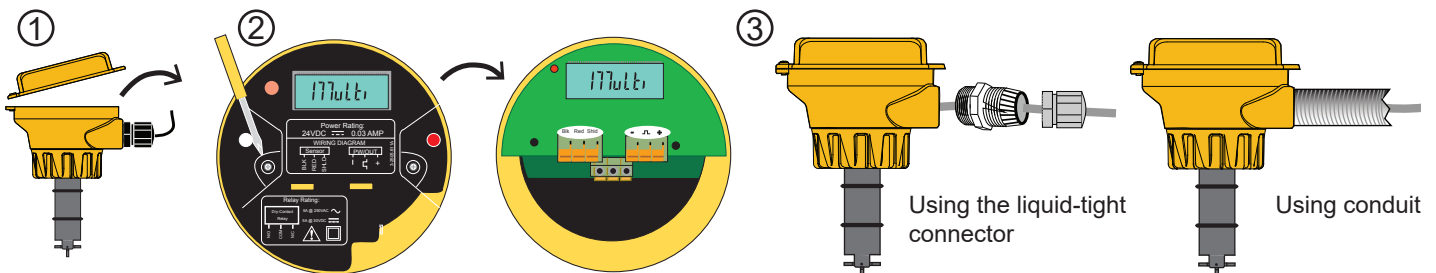

Digital (S³L) Output Wiring

The Digital (S³L) output is compatible with the 3-8900 Multi-Parameter Controller and the 3-9900 Transmitter.

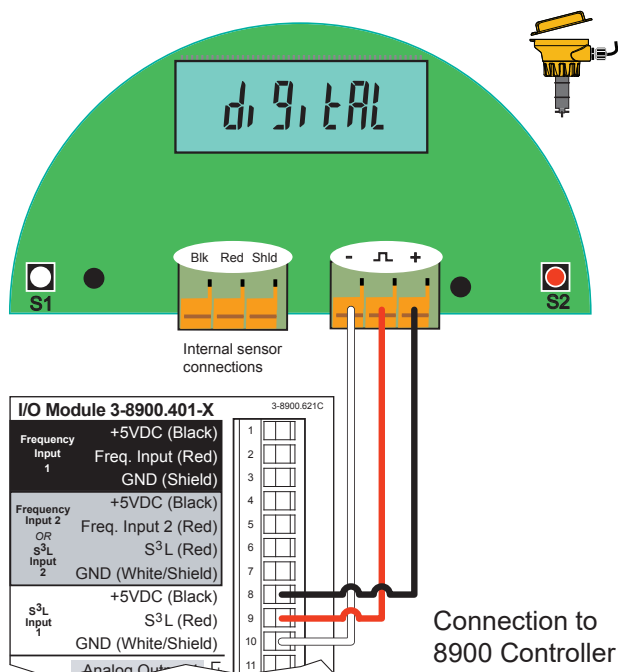
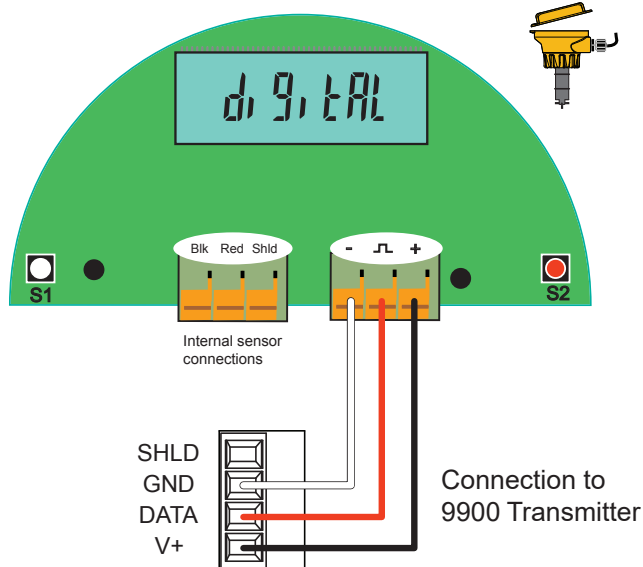
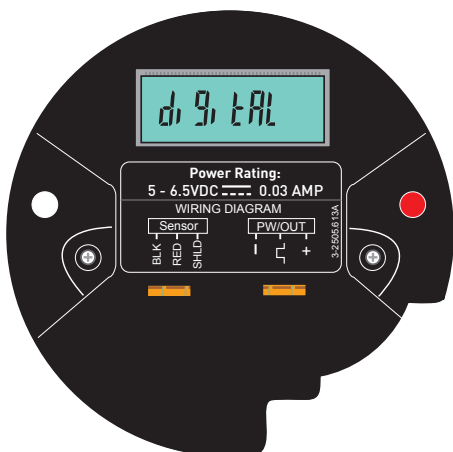

4 to 20 mA Output Wiring

- The 4 to 20 mA output can be connected to Chart Recorders, PLCs or any device that requires a 4 to 20 mA signal.
- The 4 to 20 mA model requires an external power source of 12 to 32 VDC.

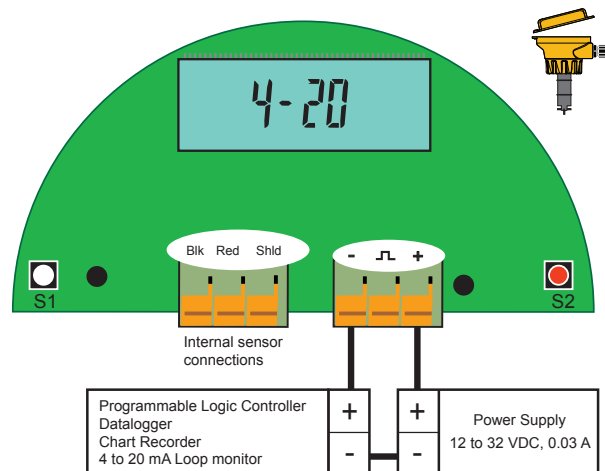

Flow Switch Output (On-Off)

- The Flow Switch mode allows a single relay that is programmable as a HIGH setpoint or LOW setpoint.
- The relay may be a dry-contact type or a solid state type:

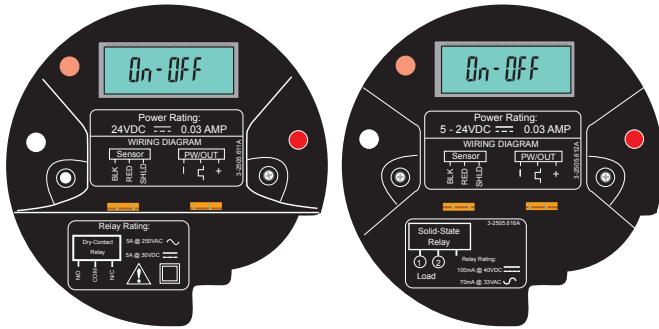

- The **Dry Contact Relay** requires an external power source of 24 VDC \pm 10%.
- The **Solid State Relay** requires an external power source of 5 to 24 VDC.

Pulse Output

- The "Multi" mode allows a single relay that is programmable as a Flow Switch, Volumetric pulse output or as a simple pulse divider output.
- The relay may be a dry-contact type or a solid state type.

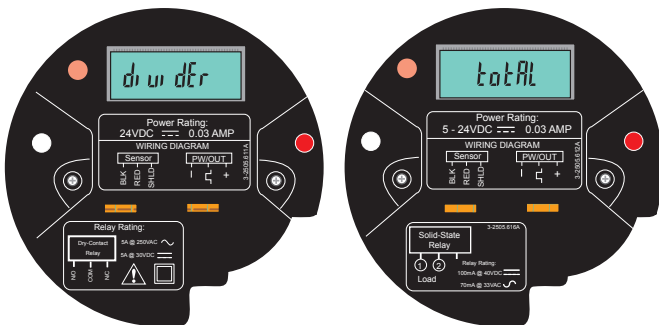

- The **Dry Contact Relay** requires an external power source of 24 VDC \pm 10%.
- The **Solid State Relay** requires an external power source of 5 to 24 VDC.
- Solid State Relay requires a pull-up resistor (10K ohm recommended). Consult your instrument/ PLC manual for wiring information.

Dry Contact Relay Wiring

- The wiring is identical for On-Off and Pulse modes.

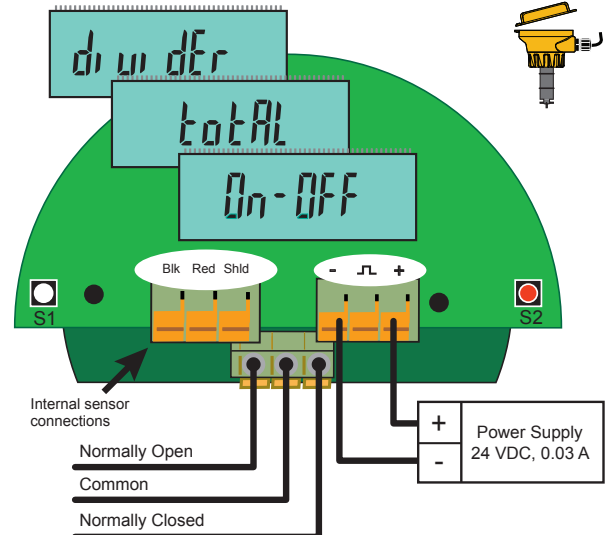

Solid State Relay Wiring

- The wiring is identical for On-Off and Pulse modes.

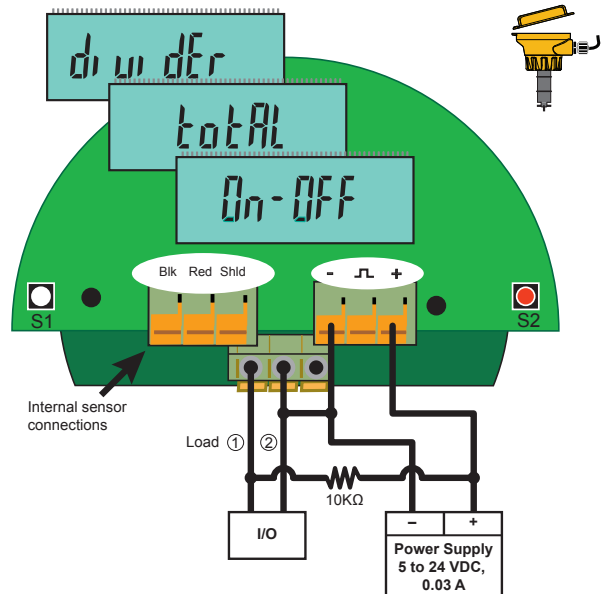

Operation

The 2537 Flowmeter is available in three different models. The programming menus vary significantly from one model to another. This chart is provided inside the yellow cover to assist in navigating the menus in the 2537.

Mode	Action		
View	→ Display Flow Rate	→ Go to MENU	Go to VIEW
Menu	1X → Next Menu	1X → Display Current Value	Previous Mode
		→ Go to Edit	Previous Mode
Edit	1X → Increment Value	1X → Shift digit to right	Previous Mode
		→ Go to SAVE	Previous Mode
SAVE	1X → Toggle	1X → Store Change	N/A

Menus

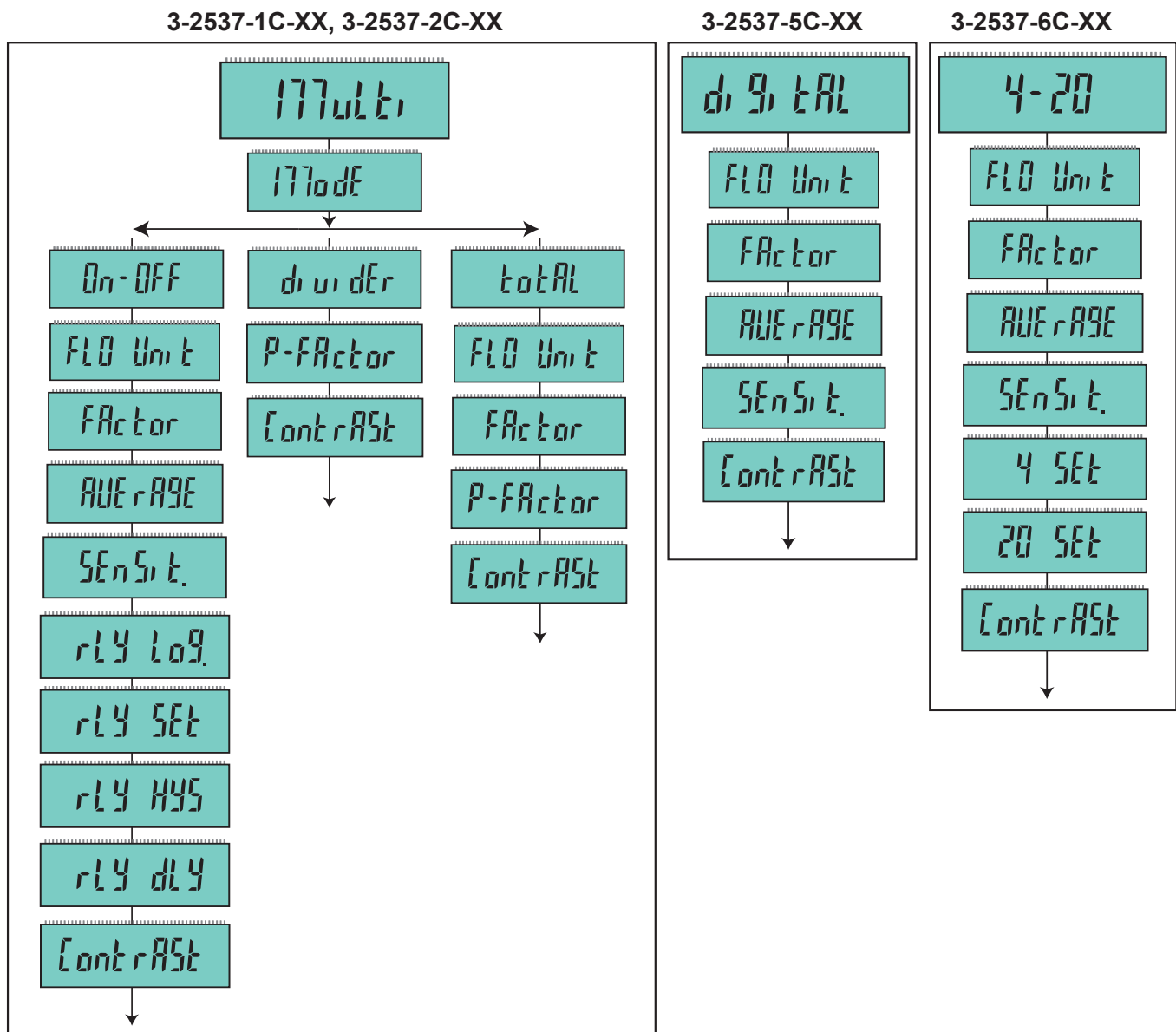

VIEW Mode Function

- All models display the model name: **Multi**, **Digital** or **4-20**.
- If the white key (S1) is held down for three seconds, the flow rate is displayed for 10 minutes before reverting back to the model name.
 - In the **Multi** Model, if the “Multi” menu item is set to “divider”, then the divided pulse output will be displayed in pulses / seconds (p/s).

Menu Details

This table shows the definition of each menu function, the setting parameters and the page where detailed instructions can be located.

Menu Function	Definition	Setting Parameters	More Information
Flow Unit	Liters or Gallons per sec., min., hour or day	See list on page 10	page 10
K-Factor	Set PULSES per VOLUME UNIT	0.0001 to 999999	page 10
Average	Smooths out erratic flow conditions	0 to 100 seconds	page 11
Sensitivity	Overrides Average for large rate changes	0 to 9	page 11
Mode	Select the output mode	Total or Divider or On-OFF	page 12
P-Factor	As PULSE DIVIDER, divides input freq.	1.0000 to 99999	page 12
P-Factor	As PULSE TOTAL, multiplies K-Factor	1.0000 to 99999	page 12
Relay Logic	Select Hi alarm or Lo alarm mode	Hi or Lo	page 13
Relay Set	Set Relay Setpoint	0.0000 to 99999	page 13
Relay Hysteresis	Rate inside Setpoint to DEENERGIZE relay	0.0000 to 99999	page 13
Relay Delay	Time delay before relay is ENERGIZED	0000.0 to 6400.0	page 13
4 Set	Set flow RATE to be represented by 4 mA	0.0000 to 99999	page 10
20 Set	Set flow RATE to be represented by 20 mA	0.0000 to 99999	page 10
Contrast	Adjust visibility of liquid crystal display	1 to 3	page 10

Set Flow Units

This function is available on these versions of the 2537:

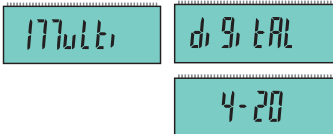

Select the volumetric units for the flow measurement:

$\frac{L}{s}$ Liters/second	$\frac{g}{s}$ Gallons/second
$\frac{L}{m}$ Liters/minute (Factory setting)	$\frac{g}{m}$ Gallons/minute
$\frac{L}{h}$ Liters/hour	$\frac{g}{h}$ Gallons/hour
$\frac{L}{d}$ Liters/day	$\frac{g}{d}$ Gallons/day

Example: Set the Flow Units to Gallons per minute:

- FLO Unit
- FLO Unit
- FLO Unit

Save the new setting:

- SAVE ? n
- SAVE ? y
- Storing .

Go to next menu item Return to Normal Operation

Set 4 and Set 20

This function is available on these versions of the 2537:

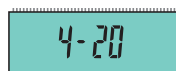

These two functions are used to span the 4 to 20 mA output signal to the required range.

The factory setting is 4 to 20 mA = 0 to 10.000

Only the 20 mA span is illustrated here.

Example: Set 20 mA = 500 GPM.

- FLO Unit
- 20 SET
- 10000
- 50000
- 50000
- 50000

Save the new setting:

- SAVE ? n
- SAVE ? y
- Storing .

Go to next menu item Return to Normal Operation

Set K-Factor

A K-Factor is the number of pulses a sensor will generate for each engineering unit of fluid that passes the sensor. The factory setting is 60.0000. Locate the K-Factor in the tables on page 14 and 15.

This function is available on the above versions of the 2537:

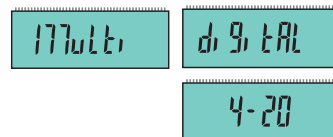

Example: Set the K-Factor to 63.5 Pulses per Gallon:

- FLO Unit
- FAc tor
- 06 0000
- 06 0000
- 06 3000
- 06 3000
- 06 3500

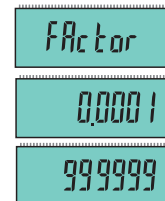

Save the new setting:

- SAVE ? n
- SAVE ? y
- Storing .

Go to next menu item Return to Normal Operation

Set Contrast

This function is available on these versions of the 2537:

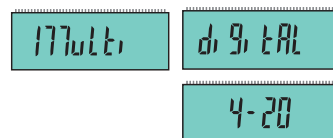

All models of the 2537 have the CONTRAST adjustment. It is always located at the end of the menu.

- To access the adjustment, enter the menu and scroll until the Contrast display appears.
- Repeat until :

Three levels of adjustment are available. The factory setting of 3 is the highest contrast setting.



Choose:

1

OR

2

OR

3

Save the new setting:

- SAVE ? n
- SAVE ? y
- Storing .

Go to next menu item Return to Normal Operation

Averaging and Sensitivity Settings

- Because ideal flow conditions are often impossible to achieve, the flow rate is often erratic, which causes erratic readings in control features (e.g., relays, 4 to 20 mA loops, etc.) that are associated with the flow rate.
- The best solution to these problems is to correct any piping deficiency that causes the instability. This may involve longer straight runs upstream, reducing the pipe size to maintain a full pipe at all times, and other installation changes. In many situations, however, these measures are simply not possible.
- The 2537 meter provides two tools that are designed to "work around" these deficiencies. The Averaging and the Sensitivity features should be studied before making adjustments.

Averaging Time in Seconds (Factory set: 0 seconds)

- Set the time the meter will use as the averaging period. The range is from 0 (no average applied to input) to 100 (seconds of averaging applied to input).

Use higher averaging times to smooth the display and current output where the flow in the pipe is erratic.

Quick Response Sensitivity (Factory set: 0)

- Set the relative degree of change in the flow rate required to allow the 2537 to disable the AVERAGING and jump to a new flow rate immediately. The scale is from 0 (least sensitive, averaging is never disabled.) to 9 (a very small change in flow rate will disable the averaging).

■■■■■ No AVERAGING, no SENSITIVITY

With AVERAGING set to 0 (zero) and with SENSITIVITY set to zero, the 2537 responds to every unstable shift in the flow. The dashed red line represents the actual output of the flow sensor in unstable flow conditions.

■■■■■■■■ AVERAGING only

With AVERAGING set to 50 seconds and SENSITIVITY still set to zero the flow rate is stabilized, but a sharp change in flow rate is not represented for 50 seconds or longer (dotted green line).

■■■■■■■■■■ AVERAGING and SENSITIVITY

With AVERAGING at 50 seconds and SENSITIVITY set to 4 OR 5, the flow rate is stabilized, while the sudden shift in flow is reflected very quickly (solid blue line).

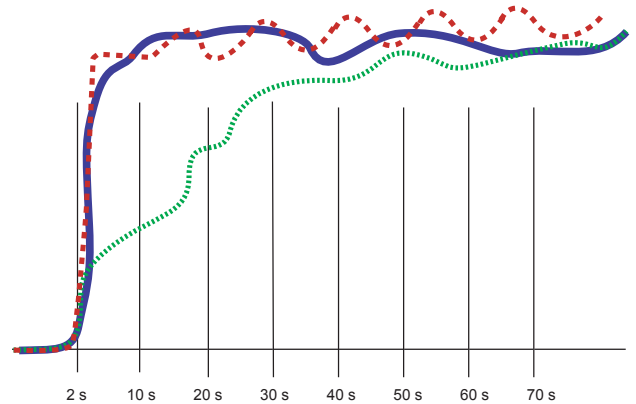

NOTE: The SENSITIVITY function is ineffective if the AVERAGING function is set to zero (seconds).

Set Averaging

This function is available on these versions of the 2537:

di g, tAL 4-20

The factory setting is 0 (zero).

AVERAGE

Minimum value 000_s

Maximum value 100_s

Example: Set the Averaging for 50 seconds.

1. 2s FLO Unit
2. x2 AVERAGE
3. 2s 000_s
4. 000_s
5. x5 050_s

Save the new setting:

1. 2s SAVE ? n
2. SAVE ? y
3. Storing .

Go to next menu item Return to Normal Operation

Set Sensitivity

This function is available on these versions of the 2537:

di g, tAL On-OFF 4-20

The factory setting is 0 (zero).

SENSIT.

Minimum value 0

Maximum value 9

Example: Set the Sensitivity to 5.

1. 2s FLO Unit
2. x3 SENSIT.
3. 2s *
4. x5 *

Save the new setting:

1. 2s SAVE ? n
2. SAVE ? y
3. Storing .

Go to next menu item Return to Normal Operation

Multi Mode

This function is available on these versions of the 2537:

177uLt,

Select **DIVIDER** or **TOTAL** operation.
The factory setting is TOTAL.

PULSE DIVIDER Output = Input pulses ÷ P-Factor

DIVIDER allows you to set a scaling value (P-Factor) from 1.0000 to 99999.

Example: If the P-Factor is set for 2, then the 2537 will output one pulse for every 2 pulses received from the sensor. This selection enables the output frequency to be scaled down to match associated equipment capabilities.

When using the PULSE DIVIDER output, associated equipment must divide the K-Factors in this manual by the P-Factor for correct calibration.

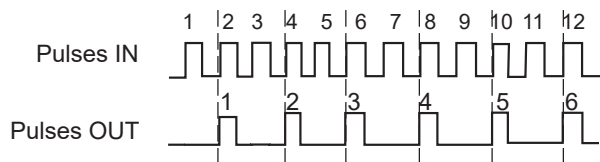

PULSE TOTAL Output = Input pulses ÷ (K-Factor × P-Factor)

TOTAL is a traditional pump pulse function. This selection will allow the entry of a K-Factor to define a volumetric unit, then set a P-Factor to define the number of volumetric units required to generate one pulse out.

Example:

Set the Total Pulse output so there is one pulse out for each 2 gallons that passes the sensor if the K-Factor is 3.0.

1. K-Factor = 3.0 (pulses in per gallon)
2. P-Factor = 2 (gallons out per pulse)

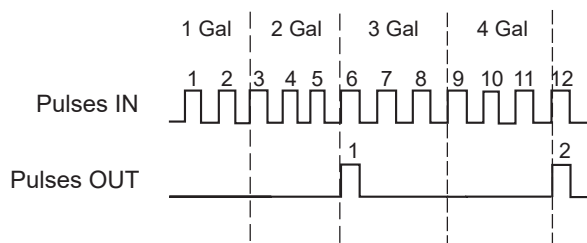

1. 177ode

2. total

3. divider

On OFF

Save the new setting:

SAVE ? n

SAVE ? y

storing.

Go to next menu item

Return to Normal Operation

P-Factor

This function is available on the above versions of the 2537:

177uLt,

divider

total

The factory setting is 1.0000

P-Factor

Minimum value

1.0000

Maximum value

99999

In PULSE DIVIDER mode the P-Factor divides:

The pulse stream from the paddlewheel sensor will be divided by the P-Factor. The resulting frequency is output through a relay.

In PULSE TOTAL mode the P-Factor multiplies:

The pulse stream from the paddlewheel sensor is divided by the K-Factor MULTIPLIED by the P-factor. The resulting frequency is output through a relay.

1. P-Factor
2. 1.0000
3. 0.0000
4. 0.0000
5. 0.0000

Save the new setting:

SAVE ? n

SAVE ? y

storing.

Go to next menu item

Return to Normal Operation

Set Relay Operation

The On-OFF mode has one relay (SPDT or solid-state) that can be programmed as a HIGH (Hi) alarm or a LOW (Lo) alarm.



1. Select HI or LO Relay Alarm logic

A HI alarm will be activated when the flow rate rises ABOVE the setpoint.

A LO alarm will be activated when the flow rate falls BELOW the setpoint.

The factory setting is Hi(gh).

Example: Change the Relay Logic to Low:

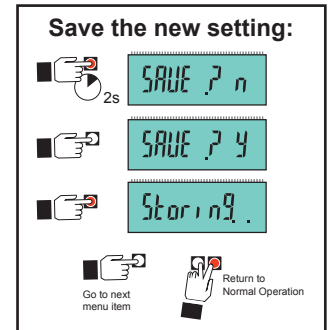
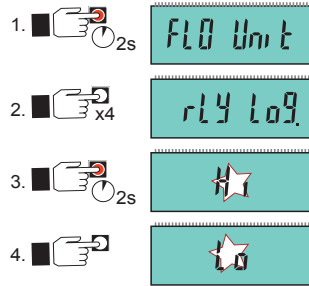

2. Program the SETPOINT.

The SETPOINT is the flow rate where the relay will be energized. The factory setting is 5.0000.

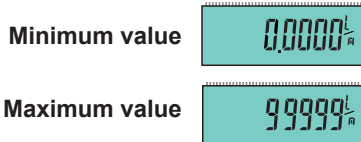

Example: Change the Setpoint to 8.0000:

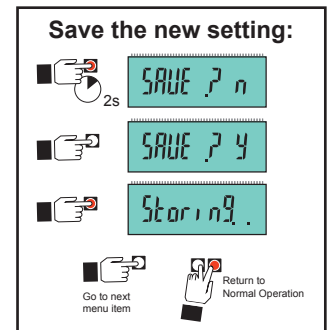
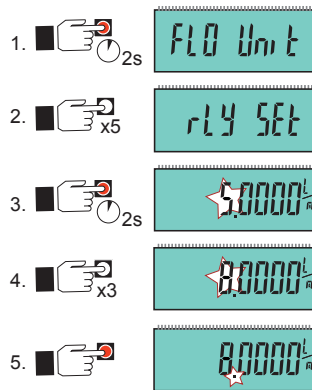

3. Program the HYSTERESIS.

Hysteresis holds a relay energized until the flow rate moves this amount past the setpoint. The factory setting is 0.5000.

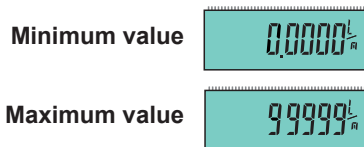

Example: Change the Hysteresis to 5.0000:

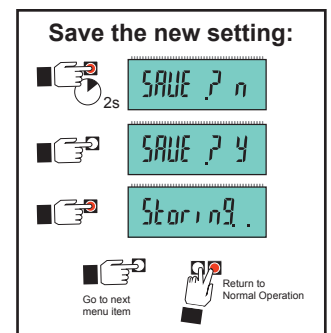
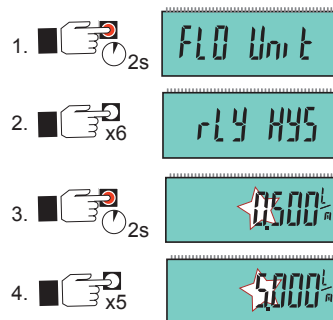

4. Program the DELAY.

When the flow rate reaches the setpoint, the 2537 will wait this long (in seconds) before triggering the alarm. The factory setting is 0000.0 seconds.

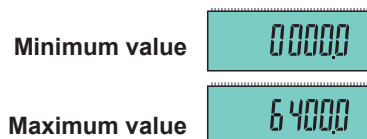

Example: Change the Delay to 10.0:

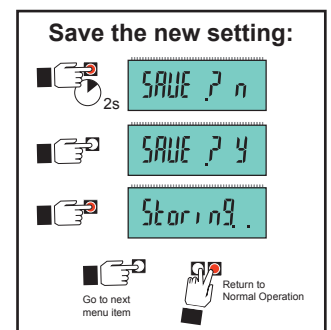
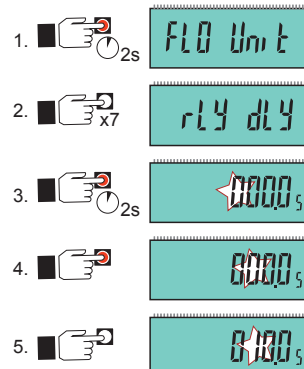

K-Factor

When using the PULSE DIVIDER mode, associated equipment must divide the K-Factors by the P-Factor.

A **K-Factor** is the number of pulses a sensor will generate for each engineering unit of fluid that passes the sensor. K-Factors for water are listed below in U.S. gallons and liters.

For example, in a 1 inch SCH 80 PVC pipe, using the MPV8T010 PVC fitting, the 2537 paddlewheel generates 335.53 pulses per gallon of water passing the rotor.

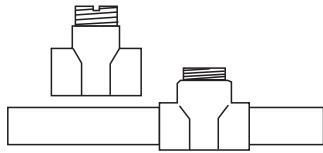

Molded Tees

PIPE SIZE (IN.)	FITTING	2537 SENSOR	
		U.S. GAL	LITERS
SCH 80 MOLDED TEES FOR SCH 80 PVC PIPE			
1/2	MPV8T005F MPV8T005 MCPV8T005F	1027.1	271.37
3/4	MPV8T007F MPV8T007 MCPV8T007F	583.19	154.08
1	MPV8T010F MPV8T010 MCPV8T010F	335.53	88.65
1-1/4	MPV8T012F MPV8T012 MCPV8T012F	178.79	47.24
1-1/2	MPV8T015F MPV8T015 MCPV8T015F	121.42	32.08
2	MPV8T020F MPV8T020 MCPV8T020F	71.44	18.87
2-1/2	PV8T025	42.994	11.359
3	PV8T030	26.652	7.0414
4	PV8T040	15.006	3.9645

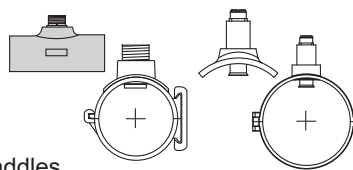

Saddles

PIPE SIZE (IN.)	FITTING	2537 SENSOR	
		U.S. GAL	LITERS
SCH 80 PVC SADDLES FOR SCH 80 PVC PIPE			
2	PV8S020	66.739	17.633
2-1/2	PV8S025	42.994	11.359
3	PV8S030	26.652	7.0414
4	PV8S040	15.006	3.9645
6	PV8S060	8.3246	2.1994
8	PV8S080	5.0164	1.3253
SCH 80 PVC SADDLE ON SCH 40 PVC PIPE			
2	PV8S020	54.700	14.452
2-1/2	PV8S025	37.159	9.8175
3	PV8S030	23.697	6.2608
4	PV8S040	13.456	3.5552
6	PV8S060	7.4594	1.9708
8	PV8S080	4.5292	1.1966

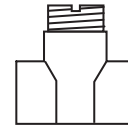

Metal Tees

PIPE SIZE (IN.)	FITTING	2537 SENSOR	
		U.S. GAL	LITERS
CARBON STEEL TEES ON SCH 40 PIPE			
1/2	CS4T005	756.00	199.74
3/4	CS4T007	438.69	115.90
1	CS4T010	286.78	75.768
1-1/4	CS4T012	121.22	32.026
1-1/2	CS4T015	91.139	24.079
2	CS4T020	54.468	14.391
STAINLESS STEEL TEES ON SCH 40 PIPE			
1/2	CR4T005	734.20	193.98
3/4	CR4T007	412.10	108.88
1	CR4T010	252.70	66.764
1-1/4	CR4T012	128.12	33.849
1-1/2	CR4T015	77.320	20.428
2	CR4T020	45.780	12.095
GALVANIZED IRON TEES ON SCH 40 PIPE			
1	IR4T010	213.01	56.277
1-1/4	IR4T012	127.75	33.751
1 1/2	IR4T015	94.401	24.941
2	IR4T020	59.420	15.699
BRONZE TEES ON SCH 40 PIPE			
1	BR4T010	213.01	56.277
1-1/4	BR4T012	127.75	33.751
1-1/2	BR4T015	94.401	24.941
2	BR4T020	59.420	15.699
COPPER TEE ON COPPER PIPE SCH K			
1/2	CUKT005	917.84	242.50
3/4	CUKT007	428.27	113.15
1	CUKT010	256.43	67.749
1-1/4	CUKT012	176.44	46.615
1-1/2	CUKT015	115.69	30.565
2	CUKT020	63.385	16.746
COPPER TEE ON COPPER PIPE SCH L			
1/2	CUKT005	858.22	226.74
3/4	CUKT007	385.74	101.91
1	CUKT010	241.64	63.841
1-1/4	CUKT012	170.90	45.152
1-1/2	CUKT015	112.03	29.598
2	CUKT020	61.74	16.310

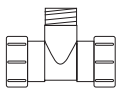

Union Tees

PIPE SIZE	FITTING	2537 SENSOR	
		U.S. GAL	LITERS
POLYPROPYLENE TEES (DIN/ISO, BS, ANSI)			
DN15	PPMT005	952.87	251.75
DN20	PPMT007	563.10	148.77
DN25	PPMT010	291.60	77.042
DN32	PPMT012	169.22	44.709
DN40	PPMT015	103.90	27.450
DN50	PPMT020	60.789	16.060
DN65	PPMT025	41.498	10.964
DN80	PPMT030	26.786	7.0769
DN100	PPMT040	17.415	4.6011
DN125	PPMT050	10.168	2.6864
DN150	PPMT060	7.3119	1.9318
DN200	PPMT080	3.9946	1.0554

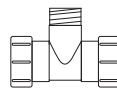

Union Tees

PIPE SIZE	FITTING	2537 SENSOR	
		U.S. GAL	LITERS
PVDF FITTINGS (DIN/ISO AND BS AND ANSI)			
DN15	SFMT005	827.26	218.56
DN20	SFMT007	489.87	129.42
DN25	SFMT010	283.55	74.915
DN32	SFMT012	158.59	41.899
DN40	SFMT015	86.980	22.980
DN50	SFMT020	50.385	13.312
PVC FITTINGS (DIN/ISO) - EUROPE ONLY			
DN15	PVMT005	972.37	256.90
DN20	PVMT007	485.69	128.32
DN25	PVMT010	297.27	78.540
DN32	PVMT012	170.25	44.980
DN40	PVMT015	103.71	27.400
DN50	PVMT020	59.500	15.720
DN65	PVMT025	34.973	9.2400
DN80	PVMT030	24.981	6.6000
DN100	PVMT040	16.275	4.3000
DN150	PVMT060	8.1756	2.1600
DN200	PVMT080	4.0878	1.0800

K-Factor

Weldolets and Brazolets



PIPE SIZE (IN.)	FITTING	2537 SENSOR	
		U.S. GAL	LITERS
STAINLESS STEEL WELDOLETS ON SCH 40 PIPE			
2-1/2	CR4W025	37.600	9.9339
3	CR4W030	24.340	6.4306
4	CR4W040	13.920	3.6777
5	CR4W050	10.860	2.8692
6	CR4W060	7.5200	1.9868
8	CR4W080	4.3400	1.1466
CARBON STEEL WELDOLETS ON SCH 40 PIPE			
2-1/2	CS4W025	37.600	9.9339
3	CS4W030	24.340	6.4306
4	CS4W040	13.920	3.6777
5	CS4W050	10.860	2.8692
6	CS4W060	7.5200	1.9868
8	CS4W080	4.3400	1.1466
COPPER/BRONZE BRAZOLETS ON SCH 40 PIPE			
2-1/2	BR4B025	37.600	9.934
3	BR4B030	24.340	6.431
4	BR4B040	13.920	3.678
5	BR4B050	10.860	2.869
6	BR4B060	7.5200	1.987
8	BR4B080	4.3400	1.147

Wafer Fittings



PIPE SIZE	FITTING	2537 SENSOR	
		U.S. GAL	LITERS
POLYPROPYLENE WAFER FITTINGS (DIN/ISO)			
DN65	PPMTE025 PPMTF025	41.498	10.964
DN80	PPMTE030 PPMTF030	26.786	7.0769
DN100	PPMTE040 PPMTF040	17.415	4.6011
DN125	PPMTE050 PPMTF050	10.168	2.6864
DN150	PPMTE060 PPMTF060	7.3119	1.9318
DN200	PPMTE080 PPMTF080	3.9946	1.0554
PVDF WAFER FITTINGS (DIN/ISO)			
DN65	SFMTF025	36.133	9.5465
DN80	SFMTF030	24.715	6.5297
DN100	SFMTF040	16.120	4.2589
DN125	SFMTF050	8.8624	2.3415
DN150	SFMTF060	6.4543	1.7052
DN200	SFMTF080	4.0720	1.0758

Iron Saddles

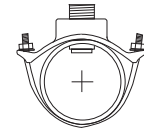

PIPE SIZE (IN.)	FITTING	2537 SENSOR	
		U.S. GAL	LITERS
SCH 80 IRON SADDLES ON SCH 80 PIPE			
2	IR8S020	64.720	17.099
2-1/2	IR8S025	42.480	11.223
3	IR8S030	26.420	6.980
4	IR8S040	14.700	3.884
5	IR8S050	12.180	3.218
6	IR8S060	8.4400	2.230
8	IR8S080	4.9000	1.295
SCH 80 IRON SADDLE ON SCH 40 PIPE			
2	IR8S020	53.640	14.172
2-1/2	IR8S025	37.600	9.934
3	IR8S030	23.220	6.135
4	IR8S040	13.260	3.503
5	IR8S050	11.040	2.917
6	IR8S060	7.2400	1.913
8	IR8S080	4.4000	1.162

H-Dimension

The plastic insert in Weldolet fittings MUST be removed during the welding process. When reinstalled, it is important that the insert be threaded to the proper height ("H" dimension).

Weldolet Part number	"H" dimension	
	inches	mm
CS4W020	2.38	60.45
CS4W025	2.33	59.18
CS4W030	2.32	58.92
CS4W040	2.30	58.42
CS4W050	3.09	78.48
CS4W060	2.96	75.18
CS4W080	2.73	69.34

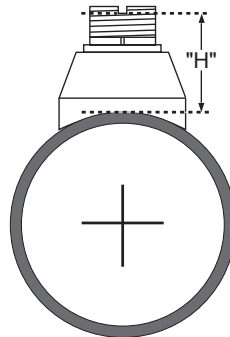

Weldolet Part number	"H" dimension	
	inches	mm
CR4W020	2.38	60.45
CR4W025	2.33	59.18
CR4W030	2.32	58.92
CR4W040	2.30	58.42
CR4W050	3.09	78.48
CR4W060	2.96	75.18
CR4W080	2.73	69.34

Maintenance and Cleaning

The 2537 requires very little maintenance.

- If the paddlewheel becomes fouled, it can be cleaned with mild detergents and a small brush.
- The electronics portion of the 2537 does not require maintenance or cleaning.

Rotor Replacement Procedure

1. To remove the rotor, insert a small screwdriver between the rotor and the ear of the sensor.
2. Twist the screwdriver blade to flex the ear outward enough to remove one end of the rotor and pin. DO NOT flex the ear any more than necessary! If it breaks, the sensor cannot be repaired.
3. Install the new rotor by inserting one tip of the pin into the hole, then carefully flex the opposite ear back enough to slip rotor into place.

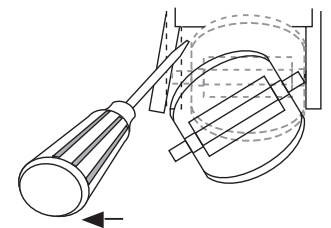

Ordering Information

Mfr. Part No.	Code	Description
2537 system for 0.5 in. to 4 in. pipes:		
Polypropylene body, Black PVDF rotor, Titanium pin, FPM O-rings		
3-2537-1C-P0	159 001 291	Pulse/Flow Switch, DCR, -P0, Integral Mount
3-2537-2C-P0	159 001 292	Pulse/Flow Switch, SSR, -P0, Integral Mount
3-2537-5C-P0	159 001 295	Digital (S ³ L), Integral Mount
3-2537-6C-P0	159 001 296	4 to 20 mA, Integral Mount

2537 system for 5 in. to 8 in. pipes:

Polypropylene body, Black PVDF rotor, Titanium pin, FPM O-rings		
3-2537-1C-P1	159 001 303	Pulse/Flow Switch, DCR, -P1, Integral Mount
3-2537-2C-P1	159 001 304	Pulse/Flow Switch, SSR, -P1, Integral Mount
3-2537-5C-P1	159 001 307	Digital (S ³ L), Integral Mount
3-2537-6C-P1	159 001 308	4 to 20 mA, Integral Mount

2537 system for 0.5 in. to 4 in. pipes:

Natural PVDF body, Natural PVDF rotor and pin, FPM O-rings		
3-2537-1C-T0	159 001 315	Pulse/Flow Switch, DCR, -T0, Integral Mount
3-2537-2C-T0	159 001 316	Pulse/Flow Switch, SSR, -T0, Integral Mount
3-2537-5C-T0	159 001 319	Digital (S ³ L), Integral Mount
3-2537-6C-T0	159 001 320	4 to 20 mA, Integral Mount

Accessories

Mfr. Part No.	Code	Description
3-2536.320-1	198 820 052	Rotor, PVDF Black
3-2536.320-2	159 000 272	Rotor, PVDF Natural
3-2536.320-3	159 000 273	Rotor, ETFE
3-2536.321	198 820 054	Rotor and Pin, PVDF Natural
3-2536.322-1	198 820 056	Sleeved Rotor, PVDF Black
3-2536.322-2	198 820 057	Sleeved Rotor, PVDF Natural
3-2536.322-3	198 820 058	Sleeved Rotor, ETFE
M1546-1	198 801 182	Rotor Pin, Titanium
M1546-2	198 801 183	Rotor Pin, Hastelloy-C
M1546-3	198 820 014	Rotor Pin, Tantalum
M1546-4	198 820 015	Rotor Pin, Stainless Steel
P51545	198 820 016	Rotor Pin, Ceramic
1220-0021	198 801 000	O-Ring, FKM
1224-0021	198 820 006	O-Ring, EPDM
1228-0021	198 820 007	O-Ring, FFKM
P31536	198 840 201	Sensor Plug, Polypro
3-8050.390-1	159 001 702	Retaining Nut Replacement Kit, NPT, Valox®
3-8050.390-3	159 310 116	Retaining Nut Replacement Kit, NPT, PP
3-8050.390-4	159 310 117	Retaining Nut Replacement Kit, NPT, PVDF
3-9000.392-1	159 000 839	Liquid tight connector kit, NPT (1 piece)
3-9000.392-2	159 000 841	Liquid tight connector kit, PG 13.5 (1 piece)
7310-1024	159 873 004	24 VDC Power Supply, 10W, 0.42 A
7310-2024	159 873 005	24 VDC Power Supply, 24W, 1.0 A
7310-4024	159 873 006	24 VDC Power Supply, 40W, 1.7 A
7310-6024	159 873 007	24 VDC Power Supply, 60W, 2.5 A
7310-7024	159 873 008	24 VDC Power Supply, 96W, 4.0 A



Georg Fischer Signet LLC, 3401 Aero Jet Avenue, El Monte, CA 91731-2882 U.S.A. • Tel. (626) 571-2770 • Fax (626) 573-2057
For Worldwide Sales and Service, visit our website: www.gfsignet.com • Or call (in the U.S.): (800) 854-4090
For the most up-to-date information, please refer to our website at www.gfsignet.com