

## CMOS Multi-Function Analog Laser Sensor IL Series

### User's Manual

Read this manual before using in order to achieve maximum performance.

After reading, keep this manual in a safe place so that you can refer to it at any time.







# Introduction

---

This manual describes the basic operations and information for the IL Series.  
Read this manual carefully to ensure performance and function of the IL Series for safe use.  
Keep this manual in a safe place for future reference.  
Make sure this manual is provided to the end user of this device.

## ■ Symbols

The following symbols alert you to important messages. Be sure to read these messages carefully.

 <b>DANGER</b>	It indicates a hazardous situation which, if not avoided, will result in death or serious injury.
 <b>WARNING</b>	It indicates a hazardous situation which, if not avoided, could result in death or serious injury.
 <b>CAUTION</b>	It indicates a hazardous situation which, if not avoided, could result in minor or moderate injury.
 <b>NOTICE</b>	It indicates a situation which, if not avoided, could result in product damage as well as property damage.

---

 **Important**

It indicates cautions and limitations that must be followed during operation.

---

 **Point**

It indicates additional information on proper operation.

---

 **Reference**

It indicates tips for better understanding or useful information.



Provides reference pages.

# Safety Precautions

## General Precautions

- At startup and during operation, be sure to monitor the functions and performance of this product and confirm normal operation.
- We recommend that you take substantial safety measures to avoid any damage in the event that a problem occurs.
- If the product is modified or used in any way other than those described in the specifications, its functions and performance cannot be guaranteed.
- When this product is used in combination with other devices, the functions and performance may be weakened, depending on the operating conditions, surrounding environment, etc.
- Do not use this product for the purpose of protecting the human body.
- Do not subject each device including peripheral devices to rapid temperature change. Product failure may occur due to condensation.

## Safety Information for the IL series

 <b>WARNING</b>	<ul style="list-style-type: none"><li>• <b>This product is just intended to detect the object(s). Do not use this product for the purpose to protect a human body or a part of human body.</b></li><li>• <b>This product is not intended for use as explosion-proof product. Do not use this product in hazardous location and/or potentially explosive atmosphere.</b></li></ul>
--	---

## Safety Precautions on Laser Products

- Use of controls or adjustments or performance of procedures other than those specified herein may result in hazardous radiation exposure.
- Follow the instructions mentioned in this manual. Otherwise, injury to the human body (eyes and skin) may result.
- Do not disassemble this product. Laser emission from this product is not automatically stopped when it is disassembled.
- Precautions on class 2 laser products
  - Do not stare into the beam.
  - Do not direct the beam at other people or into areas where other people unconnected with the laser work might be present.
  - Be careful of the path of the laser beam.  
When the laser beam is reflected or diffused from a mirror surface, and this reflection may cause danger, block this reflection using a surrounding enclosure.
  - Install the products so that the path of the laser beam is not as the same height as that of human eye.

Item		Description	
Model		IL-030	IL-S025/IL-S065/IL-065/ IL-100/IL-300/IL-600/ IL-2000
Wavelength		655 nm	655 nm
FDA (CDRH) Part1040.10	Laser Class	Class 1 Laser Product*	Class 2 Laser Product*
	Output	220 $\mu$ W	560 $\mu$ W
IEC 60825-1	Laser Class	Class 1 Laser Product	Class 2 Laser Product
	Output	220 $\mu$ W	560 $\mu$ W

\* The classification is implemented based on IEC60825-1 following the requirement of Laser Notice of FDA (CDRH).

## Safety measures for the laser

### ■ Laser radiation emission indicator

The laser radiation emission indicator is lit during laser emission. It flashes when laser emission is stopped.

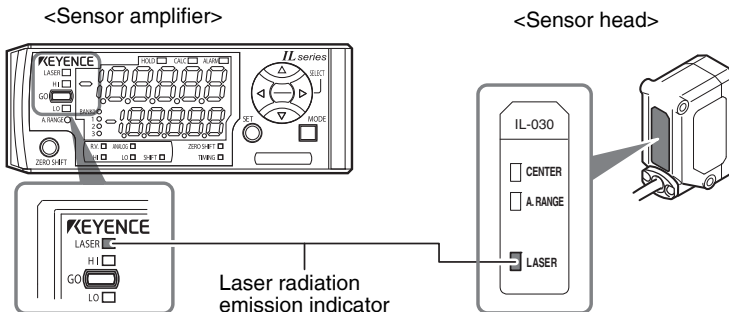

The position of the indicator of the IL-S025/IL-S065/IL-2000 will differ from above.

## Laser emission stop input

When laser emission stop input is set as an external input, laser emission can be stopped by turning on the external input (input response time 20 ms). Laser emission remains stopped while the external input is on. The laser is emitted within 20 ms being external input of the turned off. For the conditions of detection outputs and analog outputs during laser emission stop input, refer to "11. External Input" (page 4-30) of the User's Manual.

## Warming up

Leave the IL Series about 30 minutes after turning on the power.

The circuit is not stable immediately after the power turns on, so the display value may gradually fluctuate.



## Laser warning labels

The following diagrams show the type and position of laser warning labels on to the IL Series.

### IL-S025/IL-S065/IL-065/IL-100/IL-300/IL-600

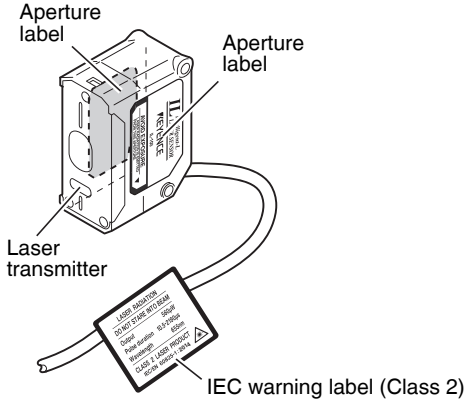

#### ■ Aperture label



#### ■ IEC warning/explanatory label (CLASS 2)

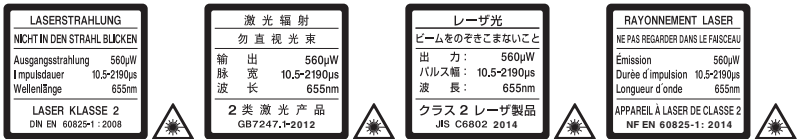

### IL-2000

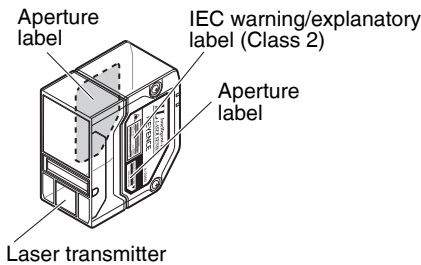

#### ■ Aperture label



## ■ IEC warning/explanatory label (CLASS 2)



The IEC warning/explanatory labels are only affixed to Class 2 laser products. Use the suitable IEC warning/explanatory label included in the package of this product according to the countries and/or regions where this product is used. In this case, it can be affixed on the IEC warning/explanatory label, which has already been affixed to this product.

## Abnormal Conditions

<div style="border: 1px solid black; padding: 2px; width: fit-content; margin: 0 auto;">NOTICE</div>	<p>If the following conditions occur, turn OFF the power immediately. Continuing to use this product under abnormal conditions may cause product failure.</p> <ul style="list-style-type: none"> <li>• When water or foreign matter enters the IL Series</li> <li>• When the IL Series is dropped or the case is damaged</li> <li>• If smoke or unpleasant odor is present.</li> </ul>
--	--

## Precautions on Use

<div style="border: 1px solid black; padding: 2px; width: fit-content; margin: 0 auto;">  CAUTION         </div>	<ul style="list-style-type: none"> <li>• Use with the correct power source and voltage. Otherwise, fire, electric shock or product failure may result.</li> <li>• Do not attempt to open or modify the IL Series. Doing so may cause fire or electric shock.</li> </ul>
<div style="border: 1px solid black; padding: 2px; width: fit-content; margin: 0 auto;">NOTICE</div>	<ul style="list-style-type: none"> <li>• Before disconnecting the cables, make sure to turn off the main unit and devices connected to the main unit. Otherwise, the unit may be damaged.</li> <li>• Do not turn off the power while modifying settings. Some or all of the setting data may be lost.</li> </ul>

## Installation environment

To use this product normally and safely, do not install this product in the following locations. Product failure may occur.

- High-humidity, dusty and poorly-ventilated locations
- High-temperature locations where the unit is exposed to direct sunlight
- Locations where there is corrosive or combustible gas
- Locations where the unit may be directly subjected to vibration or impact
- Locations where water, oil or chemicals may splash onto the unit
- Locations where static electricity tends to be generated

---

## Influence of dirt

---

Measurement errors may occur due to dust, water, oil, etc.

- Blow away dirt on the transmitter and the receiver with clean air. Wipe with a soft cloth moistened with alcohol for heavy dirt.
- Blow away the dirt attached to the object with clean air or wipe it off.
- If dirt is floating in the measurement range, take adequate measures, such as installing a protective cover or air purge.

## Anti-noise prevention

---

When the unit is installed near electric noise source such as a power source or high-voltage line, operational errors or product failure may occur. Take adequate measures such as using a noise filter, arranging cables separately or insulating the sensor amplifier and the sensor head.

## Power ON Reset

---

After the power is turned ON, it will take approx. two seconds for the measurement to start. The judgment results will be output after the sampling period has elapsed.

## Other Precautions

### Power source

---

- Noise superimposed on the power supply may cause malfunction. Use a direct current stabilized power source which uses an insulation transformer.
- When using a commercially available switching regulator, make sure to ground the frame ground terminal.

## Precautions on Regulations and Standards

### CE Marking

---

Keyence corporation has confirmed that this product complies with the essential requirements of the applicable EC Directives, based on the following specifications. Be sure to consider the following specifications when using this product in the Member States of European Union.

#### ■ EMC Directive

- Applicable standards EMI : EN61326-1,ClassA  
EMS : EN61326-1
- The length of the sensor head cable and all I/O cables must be less than 30m.

#### Remarks

These specifications do not give any guarantee that the end-product with this product incorporated complies with the essential requirements of EMC Directive.

The manufacturer of the end-product is solely responsible for the compliance on the end-product itself according to EMC Directive.

---

## CSA Certificate

---

IL series complies with the following CSA and UL standards and has been certified by CSA (Class 2252 05 / Class 2252 85).

- Applicable standard: CAN/CSA C22.2 No.61010-1  
UL61010-1
  - Use the following power supply.  
CSA/UL-listed power supply that provides Class 2 output as defined in the CEC (Canadian Electrical Code) and NEC (National Electrical Code), or CSA/UL-listed power supply that has been evaluated as a Limited Power Source as defined in CAN/CSA-C22.2 No. 60950-1/UL60950-1
  - Use this product at the altitude of 2000 m or less.
  - Indoor use only.
  - The sensor head cable and the sensor head connection cable must be installed in such a way as to avoid mechanical damage (e.g.: crushing).
  - The power/input-output cable for amplifier unit is for internal wiring only.
  - The following cables are rated 30 V.
    - sensor head cable
    - sensor head connection cable
    - power/input-output cable for amplifier unit
- Install these cables where it is separated from the circuit over 30 V.



# Table of Contents

---

## Introduction

Safety Precautions .....	1
General Precautions .....	1
Safety Information for the IL series .....	1
Safety Precautions on Laser Products.....	1
Abnormal Conditions.....	4
Precautions on Use.....	4
Other Precautions .....	5
Precautions on Regulations and Standards.....	5

## Chapter 1 Before Use

1-1 Checking the Package Contents .....	1-2
Sensor Amplifier.....	1-2
Sensor Head.....	1-3
List of Optional Parts.....	1-3
1-2 Part Names and Functions.....	1-5
Sensor Amplifier Unit .....	1-5
Sensor Head Unit.....	1-8

## Chapter 2 Installation and Connection

2-1 Mounting and Wiring the Sensor Amplifier .....	2-2
Mounting the Sensor Amplifier.....	2-2
Sensor Amplifier Wiring .....	2-6
2-2 Connecting and Mounting the Sensor Head .....	2-8
Mounting the Sensor Head .....	2-8
Connection and Wiring.....	2-9

## Chapter 3 Basic Operations

3-1 Operation When the Power is Turned on for the First Time .....	3-2
3-2 Operations on the Main Screens.....	3-3
R.V. (Internal Measurement Value) and P.V. (Judgment Value) .....	3-3
Main Display (Upper Level).....	3-3
Sub Display (Lower Level) .....	3-4
Setting Operations .....	3-6

3-3	Initial Reset (Initialize).....	3-8
	Operation for Changing the Model of Connected Head.....	3-9
3-4	Setting the Tolerance Setting Value .....	3-10
	Manual Setting.....	3-11
	Automatic Setting (When other than step count filter) .....	3-12
	Automatic Setting (When step count filter).....	3-16
3-5	Zero Shift Function (Shifting the Internal Measurement Value (R.V.)) .	3-18
	Setting the Shift Target Value.....	3-18
	Enabling the Zero Shift .....	3-19
	Canceling the Zero Shift (Reset).....	3-19
3-6	Bank Function (Registering Multiple Tolerance Setting Values) .	3-20
	Settings Registered with the Bank .....	3-20
	How to Switch the Bank.....	3-20
3-7	Key Lock Function .....	3-21
	Starting the Key Lock.....	3-21
	Canceling the Key Lock (Unlock).....	3-21

## Chapter 4 Setting Various Functions

4-1	Setting Operations .....	4-2
	Setting Operations .....	4-2
4-2	Basic Settings and Advanced Settings .....	4-4
	List of Setting Items .....	4-4
	Setting Screen .....	4-6
	1. Measurement Direction.....	4-8
	2. Sampling Rate .....	4-8
	3. Averaging rate, Step count filter, High-pass filter.....	4-9
	4. Alarm Setting .....	4-13
	5. Output State.....	4-14
	6. Hold Function.....	4-15
	7. Timing Input .....	4-23
	8. Delay Timer.....	4-23
	9. Hysteresis .....	4-26
	10. Analog Output Scaling .....	4-27
	Analog Output Accuracy .....	4-29
	11. External Input.....	4-30
	12. Bank Switching Method .....	4-35
	13. Zero Shift Value Memory Function .....	4-38
	14. Interference Prevention Function (Only for IL-1000/1500).....	4-38

15. Display Digit.....	4-39
16. Power Saving Function.....	4-40
17. Head Display Mode.....	4-40
18. Display Color.....	4-41
4-3 Calculation Function.....	4-42
Calculation Value (CALC value) .....	4-42
Addition Mode.....	4-43
Subtraction Mode.....	4-43
Setting Method (Only Main Unit).....	4-44
4-4 Calibration Function .....	4-45
Setting method (Calibrating R.V.) .....	4-45
Setting method (Two-point calibration of calculated value (CALC value)) ....	4-48
Setting method (Three-point calibration of calculated value (CALC value))..	4-50

## Chapter 5 Specifications

5-1 Specifications .....	5-2
Sensor Head.....	5-2
Sensor Amplifier.....	5-4
5-2 Circuit Diagram.....	5-5
Output Circuit Diagram .....	5-5
Analog Output Circuit.....	5-5
Input Circuit Diagram .....	5-6
5-3 Dimensions.....	5-7
Mutual-interference .....	5-13
Spot Diameter .....	5-16
5-4 Response Time .....	5-18

## Appendix

Troubleshooting .....	A-2
Frequently Asked Questions.....	A-2
Error Displays and Corrective Actions .....	A-4
Non-Error Displays and Corrective Actions .....	A-5
Display Screen and Output.....	A-8
Factory Setting (Default Value) List .....	A-9
Index.....	A-10



---

# Before Use

# 1

This chapter describes the overview of the IL Series and the name and function of each part.

<b>1-1</b>	<b>Checking the Package Contents .....</b>	<b>1-2</b>
<b>1-2</b>	<b>Part Names and Functions .....</b>	<b>1-5</b>

The following equipment and accessories are included in the package. Before using the unit, make sure that all items are included.

We have thoroughly inspected the package contents before shipment. However, in the event of defective or broken items, contact your nearest KEYENCE office.

## Sensor Amplifier

### DIN rail mount type

IL-1000 (main unit)

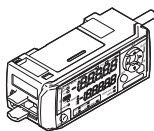

Sensor amplifier x 1  
Instruction manual x 1

IL-1050 (expansion unit)

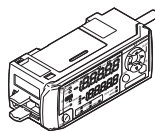

Sensor amplifier x 1

### Panel mount type

IL-1500 (main unit)

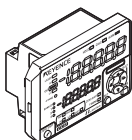

Sensor amplifier x 1

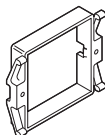

Panel mounting  
bracket x 1

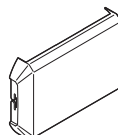

Front protection  
cover x 1



Power/Input-output cable (2 m) x 1  
(12 cores)

Instruction manual x 1

IL-1550 (expansion unit)

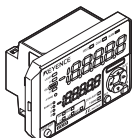

Sensor amplifier x 1

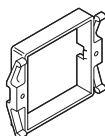

Panel mounting  
bracket x 1

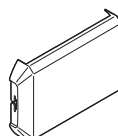

Front protection  
cover x 1



Input-output cable (2 m) x 1  
(8 cores)



Expansion cable  
(50 mm) x 1

**Sensor Head**

- IL-030 (30 mm type) -

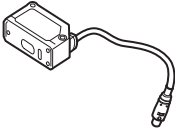

Sensor head x 1  
 Mounting bracket x 1  
 Insulating sheet x 1  
 Flat nut x 1  
 M3 x L30 screw x 2

IL-S025 (25 mm type)  
 IL-S065 (65 mm type)  
 IL-065 (65 mm type)  
 IL-100 (100 mm type)

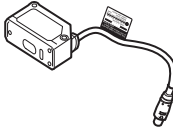

Sensor head x 1  
 Mounting bracket x 1  
 Insulating sheet x 1  
 Flat nut x 1  
 M3 x L30 screw x 2  
 Laser warning sticker x 1

- IL-300 (300 mm type)  
 IL-600 (600 mm type) -

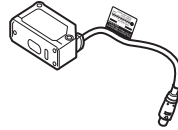

Sensor head x 1  
 Mounting bracket x 1  
 Insulating sheet x 1  
 Flat nut x 1  
 M4 x L35 screw x 2  
 Laser warning sticker x 1

IL-2000 (2000 mm type)

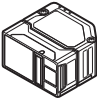

Sensor head x 1  
 M5 x L60 screw x 2  
 Laser warning sticker x 1

**List of Optional Parts**

**For sensor amplifier**

- OP-26751 (For IL-1000/IL-1050) -

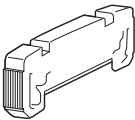

End unit  
 x 2

OP-35361 (For IL-1550) -



Expansion cable  
 (300 mm) x 1

- OP-4122 (For IL-1500/IL-1550) -

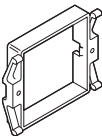

Panel mounting  
 bracket x 1

OP-87076 (For IL-1500/IL-1550) -

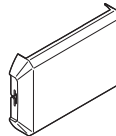



Front protection  
 cover x 1

For sensor head

1

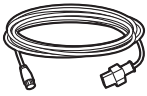
Before Use

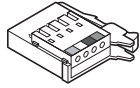
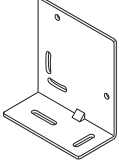
<p>OP-87056 (2 m) OP-87057 (5 m) OP-87058 (10 m) OP-87059 (20 m)</p>  <p>Sensor head connection cable (M8 straight connector) x 1</p>	<p>OP-87660 (2 m) OP-87661 (5 m) OP-87662 (10 m) OP-87663 (20 m)</p>  <p>Sensor head connection cable (M8 L-shaped connector) x 1</p>	<p>OP-84338</p>  <p>Sensor head cable connector x 2</p>
<p>OP-87606</p>  <p>IL-2000 head mounting bracket x 1 Flat nut x 1 M5 x L60 screw x 2</p>		

# 1-2 Part Names and Functions

## Sensor Amplifier Unit

### DIN rail mount type (IL-1000/IL-1050)

1

Before Use

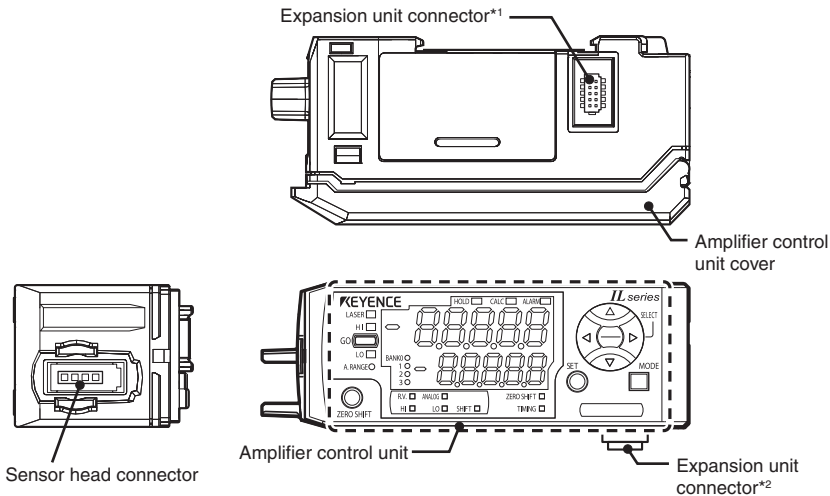

- \*1 When shipped from the factory, a protective cover is installed over the expansion slots.
- \*2 It is not installed on the main unit (IL-1000).

### Panel mount type (IL-1500/IL-1550)

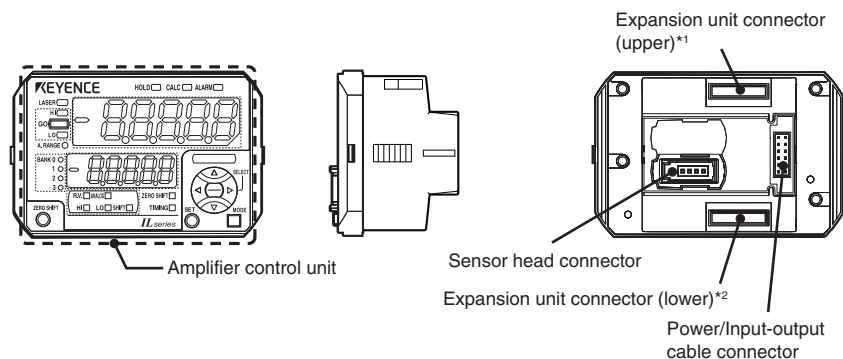

- \*1 It is not installed on the main unit (IL-1500).
- \*2 When shipped from the factory, a protective seal is attached.

Amplifier control unit

1  
Before Use



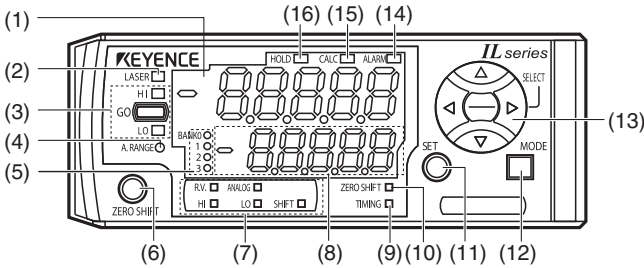

■ DIN rail mount type (IL-1000/IL-1050)

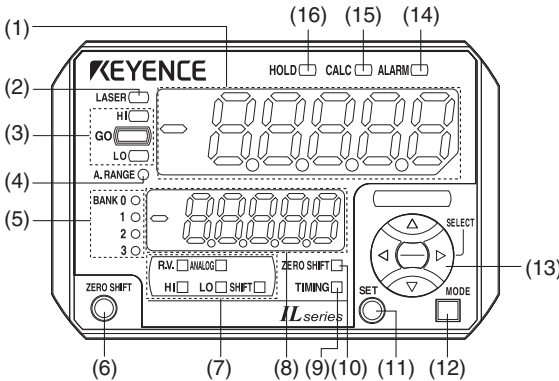

■ Panel mount type (IL-1500/IL-1550)



Item	Description
(1) Main display	Displays the judgment value (P.V.) and each setting item.
(2) Laser warning emission indicator	Lights up while the laser beam is being emitted. Blinks while the laser beam emission is stopped.
(3) Judgment indicator	Displays whether the judgment value (P.V.) is HIGH (over the upper limit), GO (within the acceptable range) or LOW (below the lower limit) against the tolerance setting value. <input type="checkbox"/> "3-4 Setting the Tolerance Setting Value" (page 3-10)
(4) Analog range indicator	Lights up when the P.V. (judgment value) is within the analog output range. If the analog output setting is OFF, or when using the expansion unit, the indicator lights within the following detection range. <ul style="list-style-type: none"> <li>• IL-S025: 25 ± 5 mm</li> <li>• IL-030: 30 ± 5 mm</li> <li>• IL-S065/IL-065: 65 ± 10 mm</li> <li>• IL-100: 100 ± 20 mm</li> <li>• IL-300: 300 ± 140 mm</li> <li>• IL-600: 600 ± 400mm</li> <li>• IL-2000: 2000 ± 1000mm</li> </ul>

Item	Description
(5) Bank indicator	Displays a bank in use.  "3-6 Bank Function (Registering Multiple Tolerance Setting Values)" (page 3-20)
(6) Zero shift button	Press this button to match the internal measurement value (R.V.) to the shift target value.  "3-5 Zero Shift Function (Shifting the Internal Measurement Value (R.V.))" (page 3-18)
(7) Sub display indicator	Lights up according to the type of values displayed on the sub display.
(8) Sub display	Displays the internal measurement value (R.V.), analog output value and each setting (selection) item.
(9) Timing input indicator	Lights up while the timing input is ON when the timing input (external input) is set to Level. Lights on approx. 0.5 sec. when the timing input is set to Edge and the timing input is turned ON.
(10) Zero shift indicator	The zero shift indicator will light up for approx. 0.5 second when the zero shift function is used.
(11) SET button	Used to automatically adjust the setting values when setting each item.
(12) MODE button	Used when setting each item, starting/ending the setting or moving items.
(13) Arrow button	Used when selecting settings, changing display contents on the sub display, etc.
(14) Alarm indicator	Lights up in the alarm state or error state.
(15) Calculation indicator	Lights up when calculation is in process using the calculation function.  "4-3 Calculation Function" (page 4-42)
(16) Hold indicator	Lights up when the Judgment Value (P.V.) is held and when the step count filter is used.  "6. Hold Function" (page 4-15)

Sensor Head Unit

IL-S025/IL-030/IL-S065/IL-065/IL-100/IL-300/IL-600/IL-2000

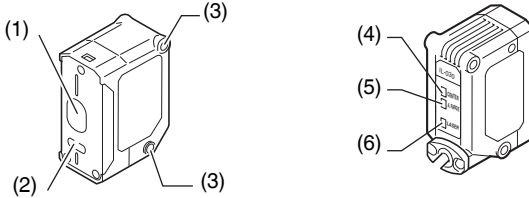

1

Before Use

Item	Description
(1) Laser receiver	Laser receiver port. The surface is covered with glass.
(2) Laser transmitter	Laser emission port. The surface is covered with glass.
(3) Mounting section	Screwed onto dedicated bracket, etc.
(4) Reference distance indicator	By default (normal display mode), and "17. Head Display Mode" (page 4-40), the reference distance indicator lights within the following detection range. <ul style="list-style-type: none"> <li>• IL-S025: 25 mm ± 0.25 mm</li> <li>• IL-030: 30 mm ± 0.25 mm</li> <li>• IL-S065/IL-065: 65 mm ± 0.5 mm</li> <li>• IL-100: 100 mm ± 1 mm</li> <li>• IL-300: 300 mm ± 7 mm</li> <li>• IL-600: 600 mm ± 20 mm</li> <li>• IL-2000: 2000 mm ± 50 mm</li> </ul>
(5) Analog range indicator	By default (normal display mode), the analog range indicator lights when the P.V. (judgment value) is within analog output range. The indicator lights within the following detection range, when the analog output setting is OFF and with the expansion units. <ul style="list-style-type: none"> <li>• IL-S025: 25 mm ± 5 mm</li> <li>• IL-030: 30 mm ± 5 mm</li> <li>• IL-S065/IL-065: 65 mm ± 10 mm</li> <li>• IL-100: 100 mm ± 20 mm</li> <li>• IL-300: 300 mm ± 140 mm</li> <li>• IL-600: 600 mm ± 400 mm</li> <li>• IL-2000: 2000 ± 1000 mm</li> </ul>
(6) Laser warning emission indicator	Lights up while the laser beam is being emitted. Blinks while the laser beam emission is stopped.



---

# Installation and Connection

# 2

This chapter describes precautions when installing and connecting the IL Series.

<b>2-1</b>	<b>Mounting and Wiring the Sensor Amplifier .....</b>	<b>2-2</b>
<b>2-2</b>	<b>Connecting and Mounting the Sensor Head.....</b>	<b>2-8</b>

## Mounting the Sensor Amplifier

## DIN rail mount type, main unit (IL-1000)

- 2** **1** Align the claw at the bottom of the main body with the DIN rail. While pushing the main body in the direction of the arrow (1), slant it in the direction of the arrow (2).

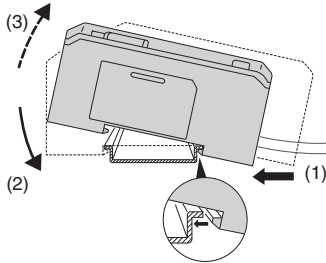

- 2** To dismount the sensor, raise the main body in the direction of the arrow (3) while pushing the main body in the direction of the arrow (1).

## DIN rail mount type, expansion unit (IL-1050)

Up to 7 expansion units can be connected to one main unit.



- Always mount expansion units onto a DIN rail.
- When connecting multiple amplifiers (expansion units), first check to make sure that the power is turned OFF to all of the main and expansion units. Connecting the units with the power turned ON may cause damage to the units.
- Push the amplifiers (expansion units) as close as possible the main unit. Improper connections may damage the equipment.



- When connecting the expansion units, make sure to initialize the connected expansion units and set the output polarity.
  - (1) When turning on the amplifier for the first time after connecting the sensor head
    - ☐ "3-1 Operation When the Power is Turned on for the First Time" (page 3-2)
  - (2) When performing the initial reset
    - ☐ "3-3 Initial Reset (Initialize)" (page 3-8)
- Expansion units with different setting of output polarity (such as an NPN output expansion unit to a PNP output main unit) cannot be connected together.
- Expansion units of DIN rail mount type cannot be connected to the main unit of panel mount type.

**1** Remove the expansion protective cover from the IL-1000 (main unit).

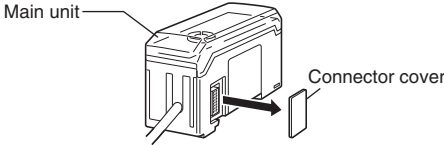

**2** Install the amplifiers (expansion units) on the DIN rail.

Refer to "DIN rail mount type, main unit (IL-1000)" (page 2-2) for details about how to mount.

**3** Push the expansion unit into the main unit connector until a clicking sound can be heard.

The expansion unit installed next to the main unit is referred to as expansion unit 1. Subsequent expansion units are referred to as expansion unit 2, expansion unit 3, etc.

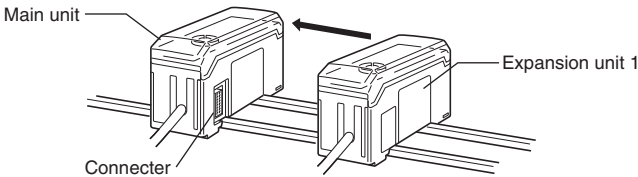

**4** Install the end units (OP-26751: 2 units in a set) (optional accessory) on both sides of the amplifiers (main and expansion units). Secure the end units in place with screws on top (2 on each end unit).

The end units are mounted in the same way as the amplifiers.

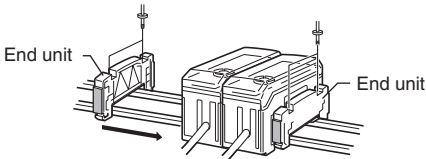

**! Point**

Fix the amplifiers securely using the end units (OP-26751: 2 units in a set) (optional accessory) or commercially available DIN rail fixing tool to prevent the amplifiers from slipping the DIN rail or coming off from the DIN rail due to machine vibration.

Panel mount type, main unit (IL-1500)

**1 Make a hole on the panel as shown in the diagrams below.**

When stacking the units vertically.

When stacking the units horizontally.

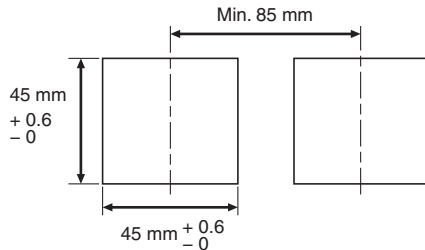
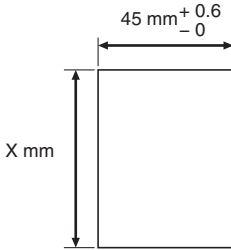

- Panel thickness 1 to 6 mm
- $X=48 \times (\text{number of amplifiers}) - 3$

**2 Insert the amplifier into the panel.**

**3 Arrange the panel mounting bracket as shown below, attach the bracket to the amplifier from the back and attach the front protection cover to the amplifier.**

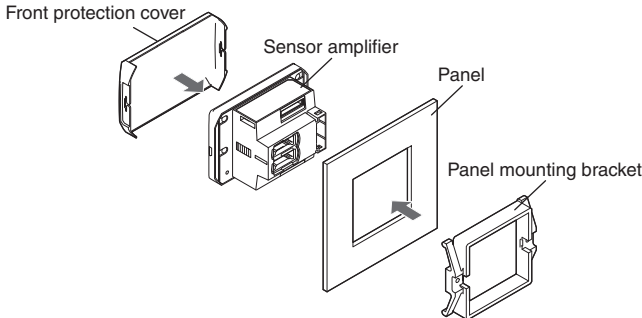

To remove the panel mounting bracket, widen the claws at both ends of the panel mounting bracket using a screwdriver, etc. and remove alternately.

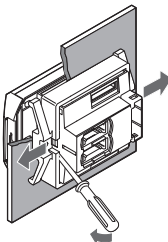

## Panel mount type, expansion unit (IL-1550)

Up to 7 expansion units can be connected to one main unit.

	<ul style="list-style-type: none"> <li>• Turn OFF the power before connecting the expansion cable. Inserting or removing the cable with the power turned on may cause damage to the units.</li> <li>• Be sure to completely connect the expansion cable. Improper connections may damage the equipment.</li> </ul>
---	--

**!** Point

- When connecting the expansion units, make sure to initialize the connected expansion units and set the output polarity.
  - (1) When turning on the amplifier for the first time after connecting the sensor head
    - ☐ "3-1 Operation When the Power is Turned on for the First Time" (page 3-2)
  - (2) When performing the initial reset
    - ☐ "3-3 Initial Reset (Initialize)" (page 3-8)
- Expansion units with different setting of output polarity (such as an NPN output expansion unit to a PNP output main unit) cannot be connected together.
- Expansion units of panel mount type cannot be connected to the main unit of DIN rail mount type.

### 1 Make holes on the panel to attach according to the number of amplifiers (connected expansion units).

For the panel cutout dimensions, refer to the "Panel mount type, main unit (IL-1500)" (page 2-4).

### 2 Install the amplifiers (expansion units) on the panel.

For the amplifier mounting method, refer to the "Panel mount type, main unit (IL-1500)" (page 2-4).

### 3 Connect the amplifier (main unit) and amplifier (expansion unit) using the expansion cable (50 mm) supplied with the expansion unit.

The expansion unit installed next to the main unit is referred to as expansion unit 1. Subsequent expansion units are referred to as expansion unit 2, expansion unit 3, etc.

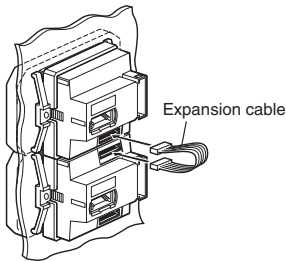

**Reference**

When arranging the amplifiers side by side, the expansion cable of 300 mm (OP-35361) is necessary.

## Sensor Amplifier Wiring

### Connecting power/Input-output cable (only for panel mount type)

Connect the power/input-output cable to the panel mount type main unit and connect the input-output cable to the expansion units.

To attach

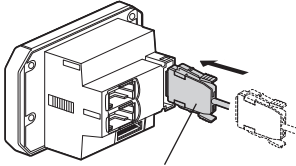

Power/Input-output cable

To remove

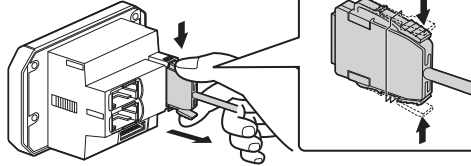

**!** Point

- The power/input-output cable for the main unit has 12 core wires, and the Input-output cable for the expansion units has 8.
- Power for the expansion units is supplied from the main unit.
- If the input-output is not used for the expansion units, cut the cable at the connector base or terminate the wires properly for future use.

Power/Input-output cable

☞ "Output Circuit Diagram" (page 5-5)

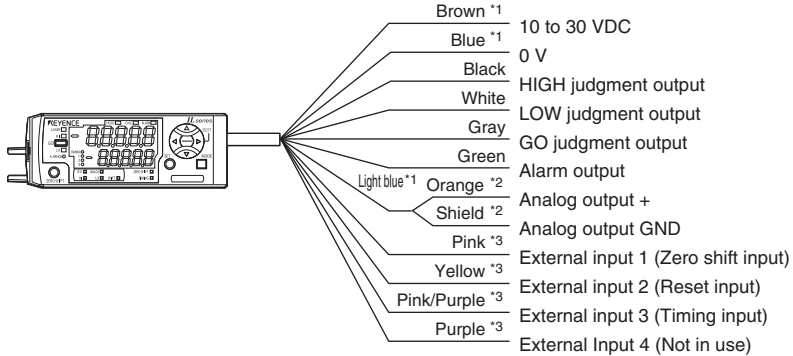

\*1 IL-1050/IL-1550 (expansion units) do not have brown, blue or light blue wires. Power is supplied to the expansion units through IL-1000/IL-1500 (main unit).

\*2 The analog output can be set to any of the following options either "When the power is turned on for the first time" or "When performing the initial reset".

- Not used (OFF)
- 0 to 5 V
- -5 to 5 V
- 1 to 5 V
- 4 to 20 mA

☞ "3-1 Operation When the Power is Turned on for the First Time" (page 3-2)

☞ "3-3 Initial Reset (Initialize)" (page 3-8)

\*3 The external input can be selected among the following in addition to the above.

- Bank A input
- Bank B input
- Laser emission stop input
- Not used (OFF)

Gain input only be selected for external input 4.

☞ "11. External Input" (page 4-30)

\*4 When expanding to six or more units, use a power supply that provides 20 to 30 V.

## Mounting the Sensor Head

Attach the sensor head using the dedicated mounting bracket.

When the dedicated bracket is not used, place the included insulation sheet between the mounting surface and the sensor head as indicated in the diagram. (When the dedicated bracket is used, or when the IL-2000 is used, the insulation sheet is unnecessary.)

**Point**

The optical axis may vary by approximately  $\pm 1.5^\circ$  (IL-S025/IL-S065/IL-2000), or  $\pm 2.0^\circ$  (IL-030/IL-065/IL-100/IL-300/IL-600).

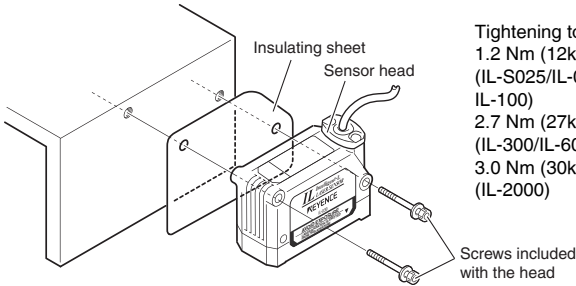

Tightening torque:  
 1.2 Nm (12kgf•cm) or less  
 (IL-S025/IL-030/IL-S065/IL-065/  
 IL-100)  
 2.7 Nm (27kgf•cm) or less  
 (IL-300/IL-600)  
 3.0 Nm (30kgf•cm) or less  
 (IL-2000)

### ● Mounting when detecting targets close to a wall ● Mounting when detecting targets in a hole

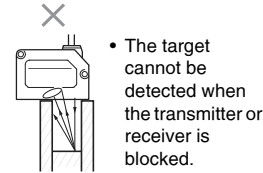
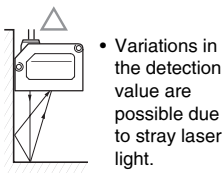
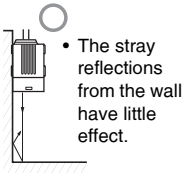

### ● When detecting uneven workpieces

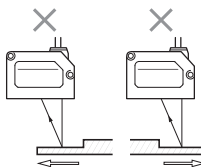
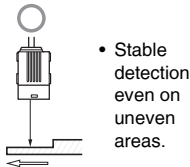

Incorrect values can be detected on uneven areas.



## Connection and Wiring

### Connecting the sensor head and amplifier

#### 1 Attach the sensor head connection cables to the sensor head cable

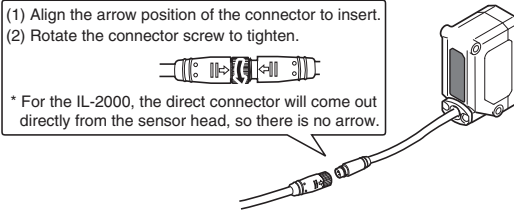

**!** Point

**Tighten the connectors securely by hand.  
 If they are loose, the IP67 environmental resistance rating cannot be guaranteed.**

#### 2 Attach the sensor head connection cable to the amplifier connector.

Remove the lock cover of the connector and insert it into the connectors of amplifier until a clicking sound is heard.

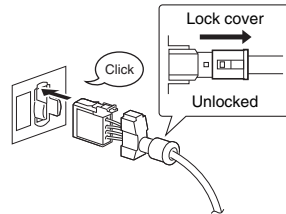

DIN rail mount type  
 (IL-1000/IL-1050)

Panel mount type  
 (IL-1500/IL-1550)

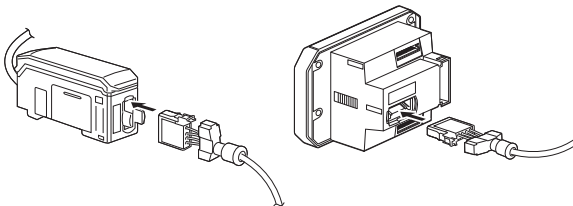

**3** Attach the lock cover to the connector to secure the cable.

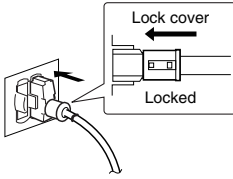

**!** Point

When removing the sensor head connection cable, push the lock lever and pull it out.

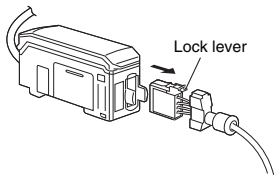

**Attaching the sensor head cable connector (OP-84338: optional accessory)**

Cut the sensor head connection cable to the required length and attach the new connector to use the sensor. The attaching method is the same for both transmitter and receiver.

- 1** Cut the cable to the required length and strip approx. 15 mm of insulation from the end of the cable.

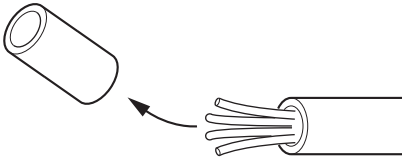

**! Point** Do not strip the core wire insulation.

- 2** Insert each cable to the end matching to the same color marks on the connector.

The cables should be inserted to the end and held in place.

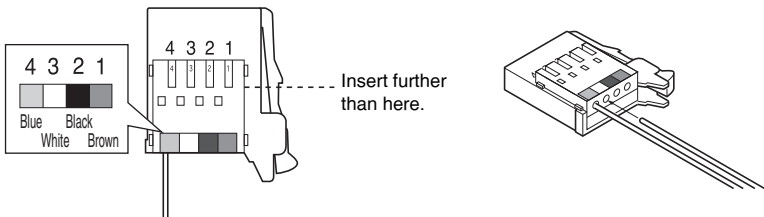

- 3** Confirm that all cables are inserted to the specified position and crimp them using pliers or a similar tool.

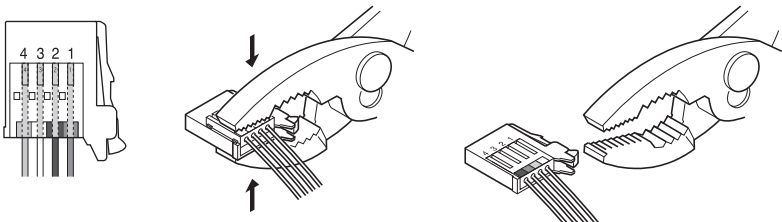

**! Point** If the connector is changed, make sure to connect it to the amplifier and confirm the normal operation.  
If it does not operate normally, crimp the connector again with pliers.  
Once the connector is crimped, it cannot be reused.

**MEMO**

**2**

---

# Basic Operations

# 3

This chapter describes basic operations and settings for the IL Series.

<b>3-1</b>	<b>Operation When the Power is Turned on for the First Time .....</b>	<b>3-2</b>
<b>3-2</b>	<b>Operations on the Main Screens .....</b>	<b>3-3</b>
<b>3-3</b>	<b>Initial Reset (Initialize) .....</b>	<b>3-8</b>
<b>3-4</b>	<b>Setting the Tolerance Setting Value .....</b>	<b>3-10</b>
<b>3-5</b>	<b>Zero Shift Function (Shifting the Internal Measurement Value (R.V.)) .....</b>	<b>3-18</b>
<b>3-6</b>	<b>Bank Function (Registering Multiple Tolerance Setting Values) .....</b>	<b>3-20</b>
<b>3-7</b>	<b>Key Lock Function .....</b>	<b>3-21</b>

When the amplifier is turned on for the first time after the sensor head is connected, the initial setting screen appears after a few seconds. Make the initial settings according to the following procedure.

The initial setting is necessary for both the main unit and the expansion units when units are added.

**Point**

Once the initial setting is completed, the initial setting display will not appear when the power is turned on the second time or the after. To change these settings, perform an initial reset.

☞ "3-3 Initial Reset (Initialize)" (page 3-8)

Power ON

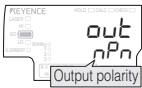

Output polarity



[MODE] button



Analog output



[MODE] button



- 1 Press ▲/▼ button to select the polarity of judgment output and edge check output, and then press [MODE] button.

Setting value	Description
nPN	NPN output
PnP	PNP output

- 2 Press ▲/▼ button to select the type of analog output and press [MODE] button. (for IL-1000 / IL-1500 only)

Setting value	Description
oFF	Not output
0-5 V	Analog output after the judgment value (P.V.) is converted to the range from 0 to 5 V.
-5-5 V	Analog output after the judgment value (P.V.) is converted to the range from -5 to 5 V.
1-5 V	Analog output after the judgment value (P.V.) is converted to the range from 1 to 5 V.
4-20 mA	Analog output after the judgment value (P.V.) is converted to the range from 4 to 20 mA.

☞ "10. Analog Output Scaling" (page 4-27)

- 3 After the setting is complete, [End] blinks several times on the sub display and the main screen appears.

- 4 Make other settings as necessary.

## R.V. (Internal Measurement Value) and P.V. (Judgment Value)

This section describes R.V. (Internal Measurement Value) displayed on the sub display (lower level) and P.V. (Judgment Value) displayed on the main display (upper level).

### R.V. (Internal Measurement Value)

R.V. (Internal Measurement Value) is the value displayed when a target is inserted into the measurement range.

\* R.V. = Raw Value

### P.V. (Judgment Value)

P.V. (Judgment Value) is the value to set the judgment output to ON/OFF according to the tolerance setting value. Also, the analog output is output based on the P.V..

\* P.V. = Present Value

☞ "3-4 Setting the Tolerance Setting Value" (page 3-10)

The Judgment value (P.V.) and the Internal Measurement Value (R.V.) are in general the same value. However, when the hold function or step-count filter is used, or when only the calculation function is used, they will become different values.

☞ "6. Hold Function" (page 4-15)

☞ "4-3 Calculation Function" (page 4-42) (page 4-39)

## Main Display (Upper Level)

The judgment value (P.V.) is displayed on the main display.

The display varies as below according to each function to be used such as Normal, Hold function, Calculation function.



### Normal

The same value as the internal measurement value (R.V.) is displayed as a judgment value (P.V.).



### When the hold function is used, when the step count filter is used

The judgment value (P.V.) is held according to the hold function settings. The Judgment Value (P.V.) is held according to the step count filter settings if they are stepped and acknowledged.

☞ "6. Hold Function" (page 4-15)

☞ "3. Averaging rate, Step count filter, High-pass filter" (page 4-9)



### When the calculation function is used

Main unit: Displays the calculated result (calculation value) with the calculation function as a judgment value (P.V.).

Expansion unit: The same display as for Normal

☞ "4-3 Calculation Function" (page 4-42) (page 4-39)

### Reference

When using both the hold function and calculation function with the main unit, the hold indicator [HOLD] and calculation indicator [CALC] will light. The judgment value (P.V.) on the main display will follow the hold function settings. The calculated value (CALC value) will be held and displayed as the judgment value (P.V.).

### Sub Display (Lower Level)

The sub display can be switched with the arrow button ◀▶.

According to the type of displayed value, the sub display indicator [R.V. / ANALOG / HI / LO / SHIFT] lights up.

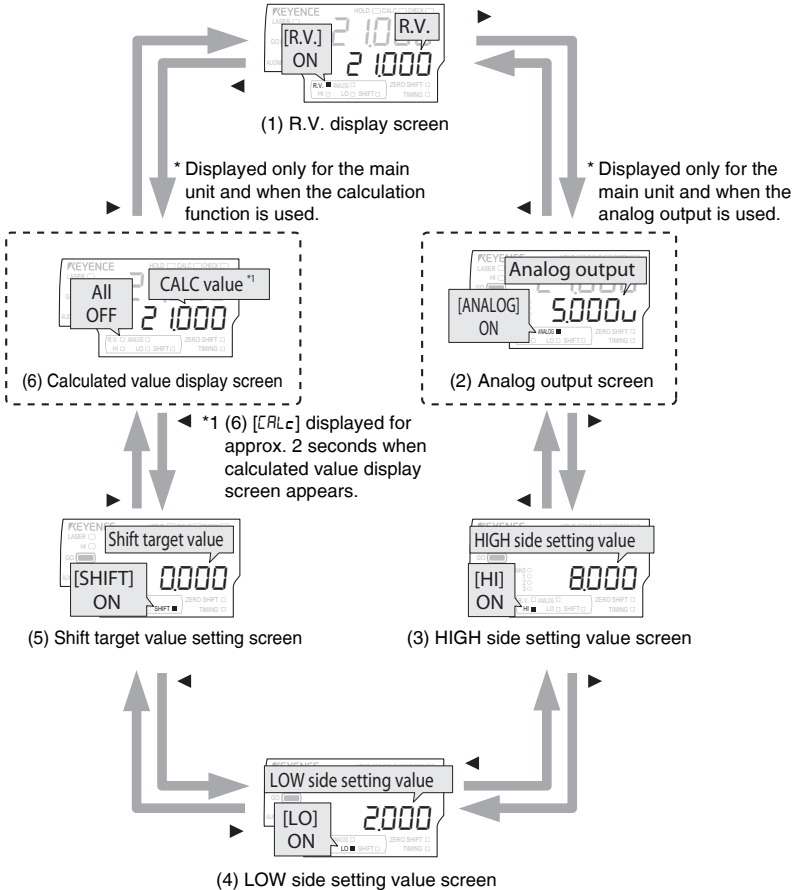



**(1) R.V. display screen**

The internal measurement value (R.V.) is displayed. The displayed value is not held.

**(2) Analog output screen (Displayed when using main unit's analog output)**

The voltage value (unit: V) or current value (unit: mA) of the analog output is displayed.

☐ "3-1 Operation When the Power is Turned on for the First Time" (page 3-2)

☐ "3-3 Initial Reset (Initialize)" (page 3-8)

**(3) HIGH side setting value screen**

The upper limit of the acceptable range (tolerance setting value) for the object is displayed. Also, the setting value can be changed. If the judgment value (P.V.) exceeds the value set here, the HIGH judgment output turns on.

☐ "3-4 Setting the Tolerance Setting Value" (page 3-10)

**(4) LOW side setting value screen**

The lower limit of the acceptable range (tolerance setting value) for the object is displayed. Also, the setting value can be changed. If the judgment value (P.V.) falls below the value set here, the LOW judgment output turns on.

☐ "3-4 Setting the Tolerance Setting Value" (page 3-10)

**(5) Shift target value screen**

When the zero shift button is pressed or the zero shift input is set to ON, the internal measurement value (R.V.) is adjusted to the value set here.

☐ "3-5 Zero Shift Function (Shifting the Internal Measurement Value (R.V.))" (page 3-18)  
(page 3-18)

**(6) Calculation value screen (Displayed when using main unit's calculation function)**

The calculated value (CALC value) is displayed. The displayed value is not held.

☐ "4-3 Calculation Function" (page 4-42) (page 4-39)

## Setting Operations

This section explains functions operable on the main screen and functions operable after the display changes to each setting screen.

### Functions Operable on the Main Screen

DIN rail mount type (IL-1000/IL-1050)

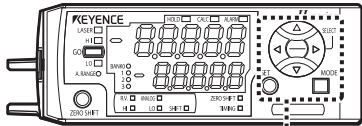

Panel mount type (IL-1500/IL-1550)

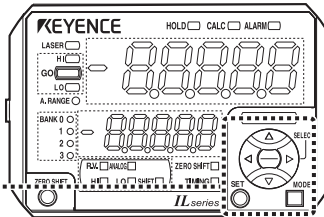

Buttons used

#### Main screen



Press ◀ or ▶ button.

#### Switching display on the sub display (lower level) (page 3-4)

Any of the internal measurement value (R.V.), analog output value, HIGH side setting value, LOW side setting value or shift target value are displayed and the settings can be changed.

#### 3-4 Setting the Tolerance Setting Value (page 3-10)

HIGH side setting value and LOW side setting value are set. The judgment is made among HIGH/GO/LOW, and the value is displayed and output.

#### 3-5 Zero Shift Function (Shifting the Internal Measurement Value (R.V.)) (page 3-18)

The internal measurement value (R.V.) can be shifted (offset) to an arbitrary shift target value.

While pressing down [MODE], press ▲ or ▼ button.

#### 3-6 Bank Function (Registering Multiple Tolerance Setting Values) (page 3-20)

HIGH side setting value, LOW side setting value, shift target value, and analog output scaling upper / lower limit value can be saved at up to four banks and switched.

Press [MODE] and ▲ buttons for approx. 2 seconds.

or

Press [MODE] and ▼ buttons for approx. 2 seconds.

#### 3-7 Key Lock Function (page 3-21)

This function prevents unwanted button operations during measurement.

---

**Available Functions from the Main Screen**

---

Main screen



Press [MODE] button for approx. 2 seconds.

**4-2 Basic Settings and Advanced Settings (page 4-4)****Basic settings**

Basic settings such as measurement mode, response time are made.

**Advanced settings**

More advanced settings such as hold function, delay timer enable the unit to be used in wider applications.

Press [MODE] and ◀ buttons for approx. 2 seconds.

**4-3 Calculation Function (page 4-42)**

The internal measurement value (R.V.) of two sets of the sensor amplifier can be calculated (addition or subtraction).

Press [MODE] and ▶ buttons for approx. 2 seconds.

**4-4 Calibration Function (page 4-45)**

When there is a difference between the internal measurement value (R.V.) or calculated value (CALC value) and the actual dimension of the object, the value can be calibrated.

While pressing the [MODE] button, press the [SET] button 5 times.

**3-3 Initial Reset (Initialize) (page 3-8)**

All settings, excluding the calibration function, are initialized.

# 3-3 Initial Reset (Initialize)

When initial reset is performed, all settings, excluding the calibration function, are initialized. The judgment output's polarity and analog output setting can be changed with the same operation.

Main screen



While pressing the [MODE] button, press the [SET] button 5 times.



[MODE] button

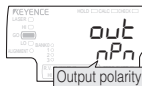

[MODE] button



[MODE] button



**1** While pressing the [MODE] button on the main screen, press the [SET] button 5 times.

[rESEt] is displayed on the main display (upper level).

**2** Press ▲/▼ button to select [YES] and press the [MODE] button.

If [no] is selected at this point, only the output polarity and analog output settings can be changed without performing the initial reset.

**3** Press ▲/▼ button to select the output polarity and press the [MODE] button.

Setting value	Description
nPn	NPN output
PnP	PNP output

**4** Press ▲/▼ button to select the analog output and press the [MODE] button. (only for IL-1000 / IL-1500 only)

Setting value	Description
oFF	Not output
0-5 u	Analog output after the judgment value is converted to the range from 0 to 5 V.
-5-5 u	Analog output after the judgment value is converted to the range from -5 to 5 V.
1-5 u	Analog output after the judgment value is converted to the range from 1 to 5 V.
0-20 mA	Analog output after the judgment value is converted to the range from 4 to 20 mA.

□ "10. Analog Output Scaling" (page 4-27)

**5** After the initialization is complete, [End] blinks several times on the sub display and the main screen is restored.

**! Point**

If the calculation function is used, perform the initial reset for the main unit first.

**Reference**

- When buttons other than the ▲/▼ button and [MODE] button are pressed during the initial reset procedure, the initial reset is canceled and the screen in step 2 is restored.
- When you attempt to initialize the unit while the key lock function is set, the screen shown on the right appears and the initialization fails.

Cancel the key lock before attempting to initialize the unit.



□ "3-7 Key Lock Function" (page 3-21)



The tolerance setting value consists of the upper limit value (HIGH side setting value) and the lower limit value (LOW side setting value). By setting these values, judgments are made in three levels: when the judgment value (P.V.) goes beyond the upper limit (HIGH judgment), when the judgment goes beyond the lower limit (LOW judgment) and when the judgment is within the acceptable range (GO judgment). Then, the judgment indicator and judgment output are turned ON/OFF.

judgment	judgment output *1			judgment indicator *2		
	HIGH	GO	LOW	HI	GO	LO
HIGH	ON	OFF	OFF	Red	OFF	OFF
GO	OFF	ON	OFF	OFF	Green	OFF
LOW	OFF	OFF	ON	OFF	OFF	Red
Error *3	ON	OFF	ON	Red	OFF	Red

\*1 When the output state of judgment output is Normally Open (default value) ON/OFF is reversed for Normal Close.

"5. Output State" (page 4-14)

\*2 The judgment indicator ON/OFF condition can be changed.

"18. Display Color" (page 4-41)

\*3 "Error Displays and Corrective Actions" (page A-4)

### DIN rail mount type (IL-1000/IL-1050)

### Panel mount type (IL-1500/IL-1550)

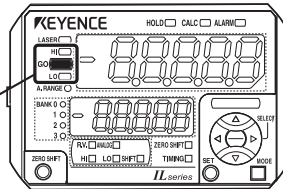
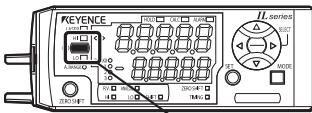

Judgment indicator

The tolerance setting value can be set either manually or automatically.

Item		Setting Method
Manual setting		Directly enter the tolerance setting value (HIGH side setting value, LOW side setting value).
Automatic setting (When other than step count filter)	Tolerance tuning	Detect the master workpiece and set the tolerance.
	2 point tuning	Detect the good target and defective target and set the tolerance.
Automatic setting (When step count filter)	2 point tuning	Detect the step, set the tolerance.
	1 point tuning	Detect the present P.V. (Judgment Value), set the tolerance.

Point

**When setting the tolerance setting value manually using the two-point tuning, make sure to set "HIGH side setting value > LOW side setting value".**

Reference

When setting "HIGH side setting value < LOW side setting value", the judgment output is as follows.

- GO judgment output is not output regardless of the judgment value (P.V.). (When setting HIGH side setting value = LOW side setting value = judgment value (P.V.) and setting the hysteresis to 0.000, GO judgment output is turned on.)
- When the judgment value (P.V.) goes beyond the HIGH side setting value and falls below the LOW side setting value, the HIGH judgment output and LOW judgment output are output at the same time.

## Manual Setting

This is the method to directly enter the tolerance setting value (HIGH side setting value, LOW side setting value).

- 1 Press the ◀ / ▶ button several times on the main screen. Then display the HIGH side setting value on the sub display (lower level).

📖 "Sub Display (Lower Level)" (page 3-4)

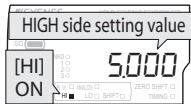

- 2 Press ▲ / ▼ button to set the HIGH side setting value.

IL-S025/IL-030/IL-S065/IL-065/IL-100

Item	Setting range	Default value
HIGH side setting value	-99.999 to 99.999	5.000

IL-300/IL-600

Item	Setting range	Default value
HIGH side setting value	-999.99 to 999.99	50.00

IL-2000

Item	Setting range	Default value
HIGH side setting value	-9999.9 to 9999.9	500.0

- 3 Press the ▶ button once and display the LOW side setting value on the sub display (lower level).

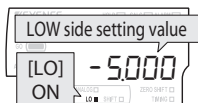

**4** Press ▲ / ▼ button to set the LOW side setting value.

IL-S025/IL-030/IL-S065/IL-065/IL-100

Item	Setting range	Default value
LOW side setting value	-99.999 to 99.999	-5.000

IL-300/IL-600

Item	Setting range	Default value
LOW side setting value	-999.99 to 999.99	-50.00

IL-2000

Item	Setting range	Default value
LOW side setting value	-9999.9 to 9999.9	-500.0

After setting, press ◀ / ▶ button to return the sub display to the original display as necessary.



As soon as the HIGH side setting value and the LOW side setting value are entered, the judgment and output begin with the new setting value.

## Automatic Setting (When other than step count filter)

### Tolerance tuning

When the target (master workpiece) as a reference is present, the HIGH side setting value (upper limit) and LOW side setting value (lower limit) can automatically be set with the master workpiece measurement value as the center value.



When the tuning result exceeds the setting range, the limit value of the setting range is considered as the setting value.



The tolerance tuning cannot be performed when the judgment value (P.V.) is displayed as [----].  
If attempting to perform, [nL uRL] blinks several times on the main display.

**1** Press the ◀ / ▶ button several times on the main screen. Then display the R.V. display screen on the sub display (lower level).

📖 "Sub Display (Lower Level)" (page 3-4)

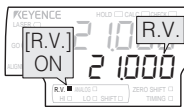

**2** Measure the master workpiece and press the [SET] button.

The judgment value (P.V.) as a reference value for the tolerance setting is imported. [SEt] and the tolerance setting width are displayed alternately on the sub display (lower level).



**3** Press ▲ / ▼ button to set the tolerance setting width.



**IL-S025/IL-030/IL-S065/IL-065/IL-100**

Item	Setting range	Default value
Setting width	0.000 to 99.999	0.200

**IL-300/IL-600**

Item	Setting range	Default value
Setting width	0.00 to 999.99	2.00

**IL-2000**

Item	Setting range	Default value
Setting width	0.0 to 9999.9	20.0

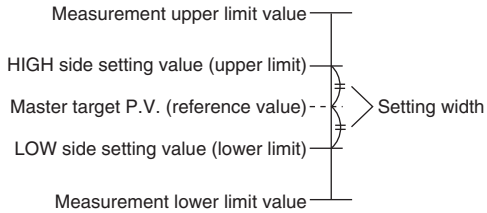

**4** Press the [SET] button to complete the tolerance tuning.

[5E] blinks on the main display (upper level), and the HIGH side setting value and LOW side setting value are determined. Then, the display returns to the R.V. screen automatically.

## 2 point tuning

With this method, the median value of the good target and defective target is set as the tolerance setting value when there are good target and HIGH/LOW defective target.

Reference

When the tuning result exceeds the setting range, the limit value of the setting range becomes the setting value.

Point

Two-point tuning is not performed if the internal measurement value (R.V.) is [-----].  
If performed, [nα uAL] will blink several times on the main display.

- 1 Press the ◀ / ▶ button several times on the main screen. Then display the HIGH side setting value on the sub display (lower level).

📖 "Sub Display (Lower Level)" (page 3-4)

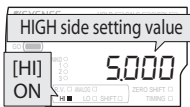

- 2 Measure the good target and press the [SET] button. (HIGH side 1st point confirmation operation)

The internal measurement value (R.V.) is imported as a good target measurement value. [H 5Eε] is displayed on the main display (upper level).

- 3 Measure the HIGH side defective target and press the [SET] button. (HIGH side 2nd point confirmation operation)

The internal measurement value (R.V.) is imported as a measurement value for HIGH side defective target.

After [5Eε] blinks on the main display (upper level), the judgment value (P.V.) is displayed.

On the sub display (lower level), the median value of the good target value (1st point) imported on step 5 and HIGH defective target value (2nd point) is displayed. Setting the HIGH side setting value (upper limit) is complete.

- 4 Press the ▶ button once and display the LOW side setting value on the sub display (lower level).

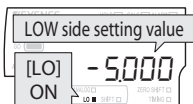

## 5 Measure the good target again and press the [SET] button. (LOW side 1st point confirmation operation)

The internal measurement value (R.V.) is imported as a good target measurement value.

[L05EE] is displayed on the main display (upper level).

## 6 Measure the LOW side defective target and press the [SET] button. (LOW side 2nd point confirmation operation)

The internal measurement value (R.V.) is imported as a measurement value for LOW side defective target.

After [5EE] blinks on the main display (upper level), the judgment value (P.V.) is displayed.

On the sub display (lower level), the median value of the good target value (1st point) imported on step 5 and LOW defective target value (2nd point) is displayed.

Setting the LOW side setting value (lower limit) is complete.

The two-point tuning is complete.

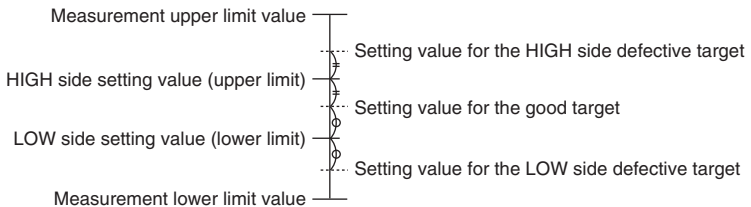

## Automatic Setting (When step count filter)

### 2 point tuning

When there is a standard step, 2 times the value of the step will be set as HIGH (upper limit value) and half of the value of the step will be set as LOW (lower limit value) automatically. If the step of the measured value of the upper part is A, and the measured part of the lower part of the step is B, it will be set as  $HIGH = |(A-B) \times 2|$ ,  $LOW = |(A-B) \div 2|$ . If the tuning result exceeds the setting range, the setting range limit will become the setting value.

 Point

When the R.V. (Internal Measurement Value) is [----], the 2 point tuning cannot occur. If it does occur, [na uAL] will be displayed on the main screen, and the number of points will decrease. The setting value cannot be changed.

- From the main screen press the ◀ / ▶ button multiple times, from the sub-display (bottom step) the R.V. (Internal Measurement Value) display screen will appear.

 "Sub Display (Lower Level)" (page 3-4)

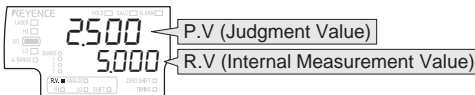

- Press the [SET] button at the top of the step.\*1  
The following screen is displayed after operation.

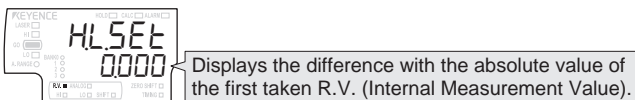

- Change the position of the work piece, press the (SET) button at the bottom of the step.\*1  
The following screen is displayed after operation.

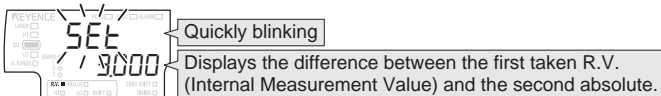

- The HIGH side setting value (upper limit value) will be set as a value double of the step, and the LOW side setting value (lower limit value) will be set as a value of half of the step.

(Example) The case below is when the upper part of the step is 5.000, the lower part of the step is 2.000.

HIGH side setting value:  $|(5.000-2.000) \times 2| = 6.000$

LOW setting side value:  $|(5.000-2.000) \div 2| = 1.500$

\*1 The upper and lower parts of 2 and 3 can be switched.



The internal measurement value (R.V.) is shifted (offset) to an arbitrary shift target value. The judgment value (P.V.) is shifted (offset) as well.

On a main unit using the calculation function, the calculated value (CALC value) will be shifted (offset) to the shift target value instead of R.V.

The following two methods can be used.

- Press the [ZERO SHIFT] button (within 1 second).
- Set the external input (zero shift input) to ON for 20 ms or more.\*

\* When the zero shift input is set for the external input 1 (pink wire), the zero shift is enabled when the input is triggered..

📖 "11. External Input" (page 4-30)

## Setting the Shift Target Value

- 1 Press the ◀ / ▶ button several times on the main screen. To display the shift target value on the sub display (lower level).

📖 "Sub Display (Lower Level)" (page 3-4)



- 2 Press ▲ / ▼ button to set the shift target value.

IL-S025/IL-030/IL-S065/IL-065/IL-100

Item	Setting range	Default value
Shift target value	-99.999 to 99.999	0.000

IL-300/IL-600

Item	Setting range	Default value
Shift target value	-999.99 to 999.99	0.00

IL-2000

Item	Setting range	Default value
Shift target value	-9999.9 to 9999.9	0.0

- 3 Press ◀ / ▶ button to return the sub display to the original screen.



Using the bank function, you can register up to four patterns of specified tolerance settings. By using the bank function, each setting item registered beforehand can be switched easily.

### Settings Registered with the Bank

Settings	Reference page
HIGH side setting value	📖 "3-4 Setting the Tolerance Setting Value" (page 3-10)
LOW side setting value	
Shift target value *1	📖 "3-5 Zero Shift Function (Shifting the Internal Measurement Value (R.V.))" (page 3-18)
Analog output free range upper limit/lower limit	📖 "10. Analog Output Scaling" (page 4-27)

\*1 The shifted amount when the internal measurement value (R.V.) is shifted using the zero shift function is saved in each bank.

(example) Suppose the zero shift function is used with bank 0, then the unit is switched to bank 1, and while in bank 1, the zero shift is used again. If the unit is switched back to bank 0, the zero shift associated with bank 0 is recalled.

### How to Switch the Bank

The bank switching method can be done in any of the 3 fashions below.

- Front panel commands on the amplifier.
- Use the external inputs (Bank A input, Bank B input)\*
- Send command from DL-RS1A (Refer to DL-RS1A User's Manual for details)

\* If the bank switching method is set to external input, and bank A input or bank B input is set for the external input, the bank can be switched with the external input.

📖 "11. External Input" (page 4-30)

📖 "12. Bank Switching Method" (page 4-35)



# 3-7 Key Lock Function

The key lock function prevents unwanted button operations during measurement. When the key lock function is active, operations other than switching the main screen and canceling the key lock function are disabled.

## Starting the Key Lock

While pressing the [MODE] button on the main screen, press ▲ or ▼ button for 2 seconds or more.

After [Loc] blinks on the main display (upper level) for several seconds, the main screen is restored.

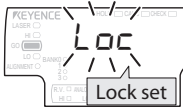

If buttons other than display switching button on the sub display (lower level) are operated in the key-locked state, [Loc] is displayed on the main display (upper level) and setting change operation is ignored.

## Canceling the Key Lock (Unlock)

While pressing the [MODE] button, press ▲ or ▼ button for 2 seconds or more.

After [unl] blinks on the sub display (lower level) for several seconds, the main screen is restored.

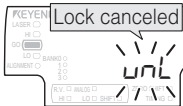

MEMO

---

# Setting Various Functions

This chapter describes the various functions of the IL Series.

<b>4-1</b>	<b>Setting Operations.....</b>	<b>4-2</b>
<b>4-2</b>	<b>Basic Settings and Advanced Settings.....</b>	<b>4-4</b>
<b>4-3</b>	<b>Calculation Function.....</b>	<b>4-42</b>
<b>4-4</b>	<b>Calibration Function.....</b>	<b>4-45</b>

# 4-1 Setting Operations

## Setting Operations

This section explains functions operable on the main screen and functions operable after the display changes to each setting screen.

### Functions Available on the Main Screen

DIN rail mount type (IL-1000/IL-1050)

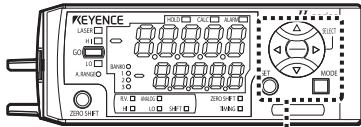

Panel mount type (IL-1500/IL-1550)

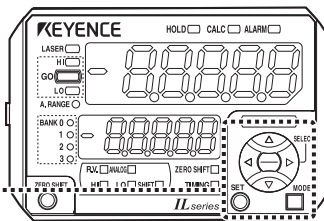

Buttons used

#### Main screen



Press ◀ or ▶ button.

#### Switching display on the sub display (lower level) (page 3-4)

The internal measurement value (R.V.), the analog output value, the HIGH side setting value, the LOW side setting value or Calculation value (CALC value) is displayed and the setting can be changed.

#### 3-4 Setting the Tolerance Setting Value (page 3-10)

HIGH side setting value and LOW side setting value are set. The judgment is made among HIGH/GO/LOW, and the value is displayed and output.

#### 3-5 Zero Shift Function (Shifting the Internal Measurement Value (R.V.)) (page 3-18)

The internal measurement value (R.V.) can be shifted (offset) to an arbitrary shift target value.

While pressing down [MODE], press ▲ or ▼ button.

#### 3-6 Bank Function (Registering Multiple Tolerance Setting Values) (page 3-20)

HIGH side setting value, LOW side setting value, shift target value, and analog output scaling upper / lower limit value can be saved in up to four banks and switched.

Press [MODE] and ▲ buttons for approx. 2 seconds.

or

Press [MODE] and ▼ buttons for approx. 2 seconds.

#### 3-7 Key Lock Function (page 3-21)

This function prevents unwanted button operations during measurement.

## Functions Available after the Display Changes to Each Setting Screen

Main screen



Press [MODE] button for approx. 2 seconds.

### 4-2 Basic Settings and Advanced Settings (page 4-4)

#### Basic settings

Basic settings such as measurement mode, response time.

#### Advanced settings

More advanced settings such as hold function, delay timer enable the unit to be used in wider applications.

Press [MODE] and ◀ buttons for approx. 2 seconds.

### 4-3 Calculation Function (page 4-42)

The internal measurement value (R.V.) made as a result of a calculation between two sensor amplifiers (addition or subtraction).

Press [MODE] and ▶ buttons for approx. 2 seconds.

### 4-4 Calibration Function (page 4-45)

When there is a difference between the internal measurement value (R.V.) or calculated value (CALC value) and the actual dimension of the object, the value can be corrected.









While pressing the [MODE] button, press the [SET] button 5 times.

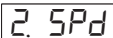

### 3-3 Initial Reset (Initialize) (page 3-8)

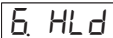
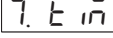
All settings, excluding the calibration function, are initialized.

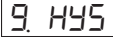
## List of Setting Items

The following items can be set.

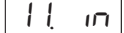
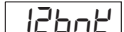
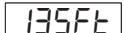
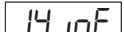
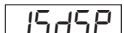
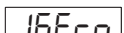
Type	Setting items	Description	Reference page
Basic setting	1. Measurement direction 	Set whether the display value increases or decreases when the object approaches the sensor head.	4-8
	2. Sampling rate 	Set the data sampling rate. To sample at a high speed, set a faster rate, and if the incoming light level is low, set a slower rate.	4-8
	3. Averaging rate, Step count filter, High-pass filter 	Set the averaging for the data retrieved from the sampling rate.	4-9
	4. Alarm setting 	Set the alarm response when the measurement range is exceeded, or when the light amount is excessive or insufficient.	4-13
	5. Output state 	According to the judgment value (P.V.), select the output state (N.O./N.C.) of judgment output ON/OFF.	4-14
Advanced setting	6. Hold function 	The hold method is set for the judgment value (P.V.).	4-15
	7. Timing input 	Set the timing input response used for the hold function.	4-23
	8. Delay timer 	Set the delay timer for the judgment output.	4-23
	9. Hysteresis 	Set the hysteresis used to stabilize the judgment output.	4-26
	10. Analog output scaling 	The analog output scaling for the judgment value (P.V.) is set.	4-27

Type	Setting items	Description	Reference page
Advanced setting	11. External input 	Select functions of the 4 external inputs.	4-30
	12. Bank switching method 	Set the bank switching method.	4-35
	13. Zero shift value memory function 	Store the settings of the state of the display based on the zero shift function into the nonvolatile memory. (EEPROM)	4-38
	14. Interference prevention function 	Set the operation of the mutual-interference prevention function.	4-38
	15. Display digit 	Set the displayed digits of the judgment value (P.V.), the internal measurement value (R.V.), and calculation value (CALC value).	4-39
	16. Power saving function 	Select power saving options for the display.	4-40
	17. Head display mode 	Select the operation of the head LED indicators.	4-40
	18. Display color 	Set the color of the judgment indicator and the display color of the main display of the panel mount type amplifier (IL-1500/IL-1550).	4-41

## Setting Screen

This section describes operations and the setting screen to modify the basic settings and the detailed setting.

### How to go to the setting screen

Press the [MODE] button for approx. 2 seconds on the main screen.  
The setting screen appears.

### Basic operations on the setting screen

Changing the setting value: ▲/▼ button  
Go to the next setting item: [MODE] button or ► button  
Return to the previous setting item: ◀ button  
Skip the rest of the settings and finish: Press and hold the [MODE] button for approx. 2 seconds.

### Setting screen view

The setting is displayed on the main display (upper level) and the setting value is displayed on the sub display (lower level).

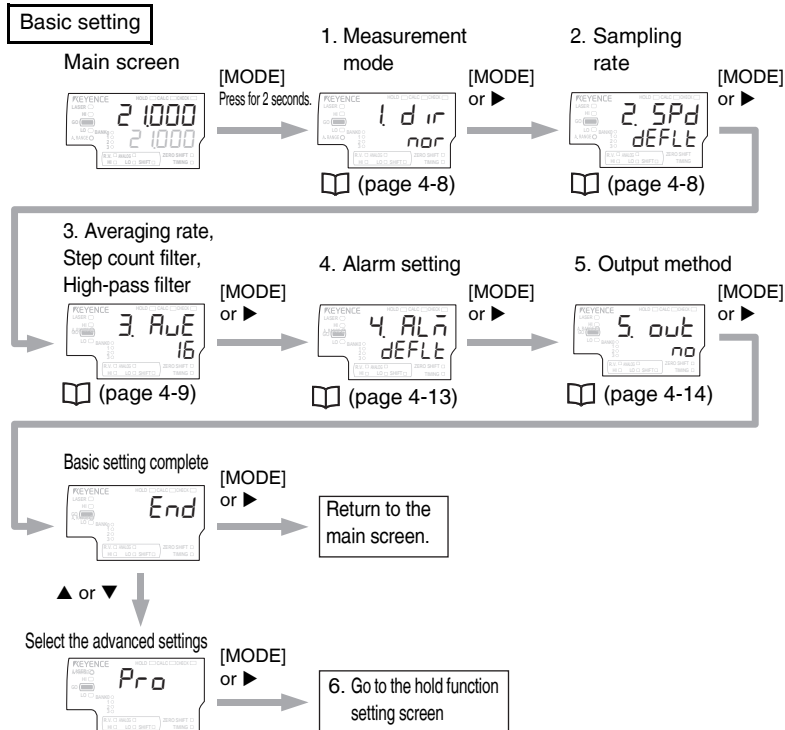



Advanced settings

From the advanced settings selection screen

[MODE]  
or ▶

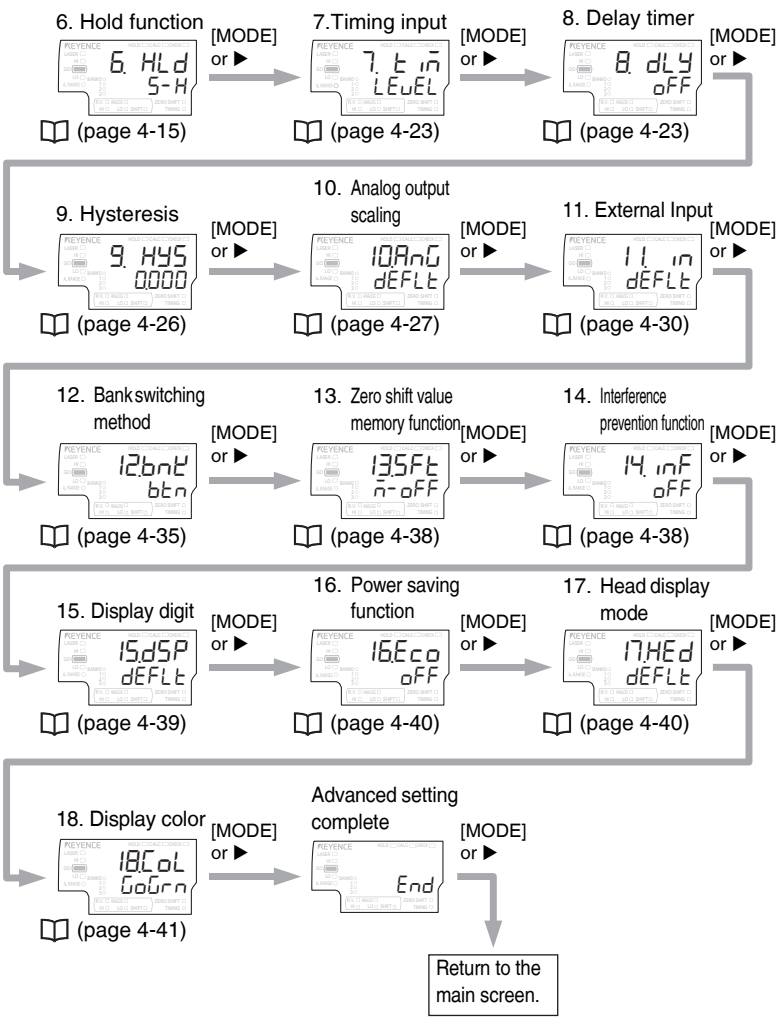

1. Measurement Direction

1 d i r

Set whether the display value increases or decreases when the object approaches the sensor head.

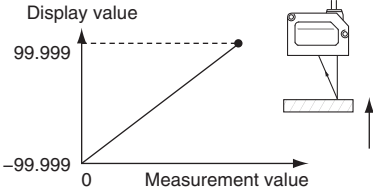
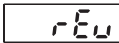
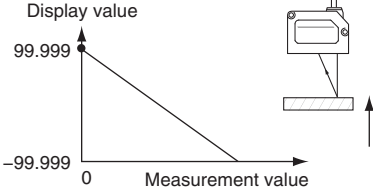
Measurement increase/decrease direction	Description	Default value
Normal 	The display value increases when the object approaches the sensor head. 	○
Reverse 	The display value decreases when the object approaches the sensor head. 	

2. Sampling Rate

2.5 Pd

Set the measurement sampling rate.

Normally the default value is used, but to sample at a faster rate, set a fast rate, and if the incoming light amount is low, set a slower rate.

Item	Setting range	Default value
Sampling rate	dEFLt / 0.33 / 1 / 2 / 5 (ms)	dEFLt

\* As for dEFLt, IL-S025/IL-030/IL-S065/IL-065/IL-100 is 1ms, IL-300/IL-600 is 2 ms, and IL-2000 is 5 ms.

 Point

- When the mutual-interference prevention function is enabled, the sampling rate of the expansion unit is set equal to that of the main unit, so the sampling rate setting screen for the expansion unit is skipped.
- When the calculation function is enabled, the sampling rate of expansion unit 1 is set equal to that of the main unit, so that the sampling rate setting screen for expansion unit 1 is skipped. Expansion unit 2 and following, units are each set individually.
- If the data between the heads is not synchronized when using the calculation function or when the DL series is connected, disable the mutual-interference prevention function and set the main unit's sampling rate to a rate other than 0.33 ms. When the mutual-interference prevention function is enabled, or 0.33 ms is set, the timing for updating the main unit and expansion unit's internal data will not match. In this case, when measuring a moving target using the calculation function, the measured value may greatly differ from the actual value.
- When the mutual-interference prevention function is enabled, 2 ms or 5 ms cannot be set for IL-S025/IL-030/IL-S065/IL-065/IL-100, and *dEFLt*, 2 ms or 5 ms cannot be set for IL-300/IL-600/IL-2000.
- If the [FrEQ] settings of the "3.AVE" of the [HPF] are set to 50 Hz/100 Hz, the IL-S025/IL-030/IL-S065/IL-065/IL-100 cannot be set to 2 ms/5 ms, and the IL-300/IL-600/IL-2000 cannot be set to *dEFLt*/2 ms/5 ms.
- When "3.AVE" is [diFF], 5 ms cannot be set.
- When using in an environment that greatly interferes with the beam, set 2 ms or 5 ms.

### 3. Averaging rate, Step count filter, High-pass filter



The averaging rate, the step count filter, and the high-pass filter data acquired by the sampling cycle will be set.

#### ■ Averaging rate

The average value is the moving average. If the measured values fluctuate, stable measurements can be obtained by increasing the average count. Also, when selecting [*dFF*], the step function, or [HPF] the High-pass filter function will be enabled.

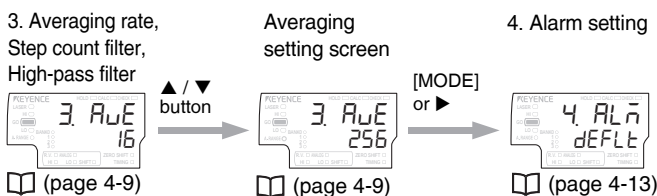

Item	Setting range (rate)	Default value
Averaging rate	1 / 2 / 4 / 8 / 16 / 32 / 64 / 128 / 256 / 512 / 1024 / 2048 / 4096 / <i>dFF</i> / HPF	16

■ Step count filter

Acknowledge the steps above the specified height (LOW setting value), it is the filter that does the one shot output. If the steps are acknowledged, the internal measurement value (R.V.) from the time that there is a sudden change in the + direction until that change has stopped will be the P.V. (Judgment Value). Also, the set one shot time, will make the Go decision output on, and will hold the P.V. (Judgment Value) until the next steps are acknowledged. The count and seam detection etc. is enabled. If [diFF] is selected using the setting screen of the averaging count, it will move to the setting screen of the continuous one shot time.

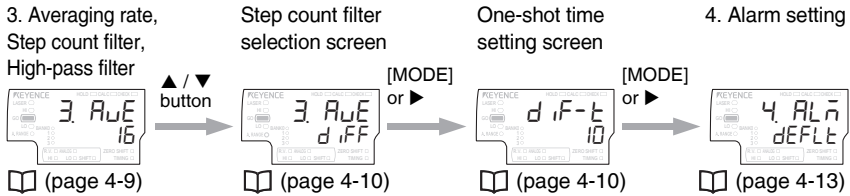

Item	Setting range (ms)	Default value
One-shot time	2 to 9999	10



**CAUTION**

- Use work pieces moving at 200 mm/s or more.
- Set the LO side setting value for approximately half of the desired step.
- While the timing input is ON, The P.V. (Judgment Value) will not renew. When OFF, The operation will restart using the first taken value as a standard.
- When the LO side setting is less than 0, no matter what step, the P.V. (Judgment Value) will not operate. Concerning LO side setting value settings, refer to  "3-4 Setting the Tolerance Setting Value" (page 3-10)
- Set the HIGH side setting value as larger than the step.
- The change of the Internal Measurement Value (R.V.) is taken and will be the Judgment Value (P.V.). Therefore, the Judgment Value will be fixed via changes in the target value of zero shift or shift.
- Set "1. Measuring Direction" so that a change of the Internal Measurement Value (R.V.) of the step portion desired to be detected becomes a change in the plus direction.
- The sampling rate will be 5 ms and when at dEFLt, the IL-2000 cannot be set to diFF.

Reference

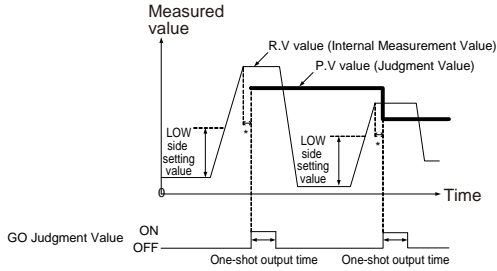

The sampling cycle is 5.5 ms when 0.33 ms, 6 ms when 5.5 ms, and 8 ms when 2 ms.

■ High-pass filter

The average value is moved and averaged. If the measured values fluctuate, stable measurements can be obtained by increasing the average number of times. When [HPF] is set, the high-pass filter will be enabled.

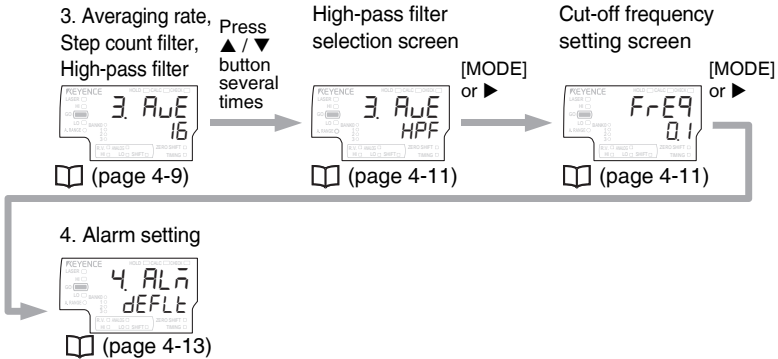

Item	Setting range (Hz)	Default value
Cut-off frequency	0 / 1 / 2 / 5 / 10 / 20 / 50 / 100	1

Reference

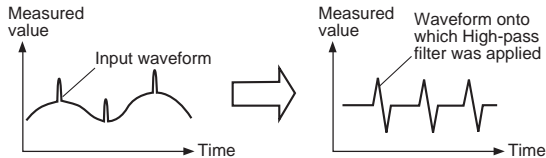

 Point

- When the mutual-interference prevention function is enabled, the averaging of the expansion units is set equal to that of the main unit, so that the averaging setting screen for expansion units is skipped. (Use of the Step counter and High-pass filter is the same)
  - When the calculation function is enabled, the averaging of expansion unit 1 is set equal to that of the main unit, so that the averaging setting screen for expansion unit 1 is skipped. Expansion unit 2 and following, units are each set individually.
  - If the data between the heads is not synchronized when using the calculation function or when the DL series is connected, set the number of main unit averaging to 256 times or less. If the averaging is set to 512 times or more, the timing for updating the main unit and expansion unit's internal data will not match. In this case, when measuring a moving target using the calculation function, the measured value may greatly differ from the actual value.
  - When the sampling cycle is set to 2 ms, 5 ms at the time of the high-pass filter, a cut off frequency of 50 Hz or over cannot be selected.
  - For amplifiers delivered before December 21st, 2010, [dIFF2]/[HPF] cannot be selected.
  - For products shipped before December 21th, 2010, that have even one amplifier, when the "14. mutual interference prevention function" is ON, [d iFF]/[HPF] cannot be selected.
  - When using the calculation function, [d iFF] cannot be selected.
  - Even if the hold function is set, it will operate as sampling hold until selected as [diFF].
  - For amplifiers with the main device shipped after December 22th 2010, and those with the extension after December 21th, 2010, while using the calculation function, [d iFF]/[HPF] cannot be selected.
-



## 4. Alarm Setting

4 ALn

The IL series cannot complete a measurement if it is outside the measurement range or if the light amount is excessive or insufficient. (If the measurement is impossible for a number of samples equal to the alarm number, "---" will appear.)

Details of operations when measurement is impossible are set with the alarm setting.

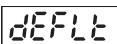
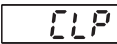
The alarm output is ON during normal measurement. It turns OFF when an alarm or error state occurs.

Setting value	Description	Default value						
Default 	When measurement is impossible, this option sets the default number of samples for which the previous normal value is held. This differs according to the set sampling rate. <table border="1" data-bbox="406 608 906 695"> <thead> <tr> <th>Sampling rate</th> <th>Sampling rate</th> </tr> </thead> <tbody> <tr> <td>0.33 ms</td> <td>6 times</td> </tr> <tr> <td>Other than 0.33 ms</td> <td>7 times</td> </tr> </tbody> </table>	Sampling rate	Sampling rate	0.33 ms	6 times	Other than 0.33 ms	7 times	○
Sampling rate	Sampling rate							
0.33 ms	6 times							
Other than 0.33 ms	7 times							
Clamp 	When measurement is impossible, the previous normal value is held until measurement is restored.							
User setting 	When measurement is impossible, this option sets the number of samples for which the previous normal value is held. The settable range is as follows: <table border="1" data-bbox="406 890 906 951"> <thead> <tr> <th>Setting range</th> <th>Default value</th> </tr> </thead> <tbody> <tr> <td>2 to 1000 times</td> <td>7 times</td> </tr> </tbody> </table>	Setting range	Default value	2 to 1000 times	7 times			
Setting range	Default value							
2 to 1000 times	7 times							

\* If measurement is impossible immediately after powering on or immediately after reset input, the display [-----] is held.

 Point

- If the default or user setting is selected and measurement remains impossible after the number of alarms, the measured value is displayed as [-----]. This is called the alarm state.
- When the amplifier is in alarm state and valid measurement values are obtained for a number of samples equal to the averaging value + 2, the amplifier recovers from the alarm state and displays the measured value.
- If measurement is restored not later than the number of sampling times specified for the default or user setting, the hold function is cancelled.
- The alarm output after power up or reset input is ON until the amplifier recognizes an unmeasurable state even if [-----] is displayed.
- The alarm output is turned ON once a reset is executed in response to reset input.
- The alarm output operates as a normally closed contact irrespective of how the output method is changed (□ "5. Output State" (page 4-14)).
- The alarm output is not held by timing input.

## 5. Output State

5 out

According to the judgment value (P.V.), set the output state (N.O./N.C.) of judgment output ON/OFF and edge check output.

Item	Setting range	Default value
Output state	no (Normally Open), n̄c (Normally Closed)	no

There are three judgment outputs as below.

- HIGH judgment output (Black wire)
- GO judgment output (Gray wire)
- LOW judgment output (White wire)

The judgment output is turned ON/OFF as below according to the tolerance setting value.

☞ "3-4 Setting the Tolerance Setting Value" (page 3-10)

### When Normally Open is set

Judgment	Judgment output		
	HIGH	GO	LOW
HIGH	ON	OFF	OFF
GO	OFF	ON	OFF
LOW	OFF	OFF	ON
Error*1	ON	OFF	ON
"-----"*2	OFF	OFF	OFF

### When Normally Closed is set

Judgment	Judgment output		
	HIGH	GO	LOW
HIGH	OFF	ON	ON
GO	ON	OFF	ON
LOW	ON	ON	OFF
Error*1	OFF	ON	OFF
"-----"*2	ON	ON	ON

\*1 ☞ "Error Displays and Corrective Actions" (page A-4)

\*2 When the judgment value (P.V.) is "-----".

**Reference**

Regardless of the output state setting, the judgment indicator on the sensor amplifier interlocks the judgment output when Normally Open is set.

☞ "3-4 Setting the Tolerance Setting Value" (page 3-10)

The following is the default state of the judgment indicator. The lighting status can be changed in the items for "18. Display Color".

☞ "18. Display Color" (page 4-41)

Judgment	Judgment output		
	HIGH	GO	LOW
HIGH	Red	OFF	OFF
GO	OFF	Green	OFF
LOW	OFF	OFF	Red
Error	Red	OFF	Red
"-----"	OFF	OFF	OFF



## 6. Hold Function

6. HLD

The holding method is set for the judgment value (P.V.).

Functions other than "Auto peak hold" and "Auto bottom hold" require the use of the external input (timing input).

## NOTICE





**When functions other than "Auto peak hold" and "Auto bottom hold" are set, assign external input 3 (pink/purple wire) to the timing input.**

☰ "11. External Input" (page 4-30)

## Reference

- While the judgment value (P.V.) is held, the hold indicator on the sensor amplifier lights up.

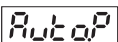
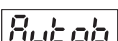

Hold Function	Description	Default value
Sample hold 	When the timing input is turned ON, the judgment value (P.V.) is held. ☰ "Sample hold" (page 4-16)	○
Peak hold 	The maximum value of the specified period (sampling period) is held as the judgment value (P.V.). ☰ "Peak hold" (page 4-17)	
Bottom hold 	The minimum value of the specified period (sampling period) is held as the judgment value (P.V.). ☰ "Bottom hold" (page 4-18)	
Peak-to-peak hold 	The difference between the maximum value and minimum value of the specified period (sampling period) is held as the judgment value (P.V.). ☰ "Peak-to-peak hold" (page 4-19)	
Auto peak hold 	According to the specified trigger level, the maximum value sampled is held as a judgment value (P.V.). The external input is not required. ☰ "Auto peak hold" (page 4-21)	
Auto bottom hold 	According to the specified trigger level, the minimum value sampled is held as a judgment value (P.V.). The external input is not required. ☰ "Auto bottom hold" (page 4-22)	

Sample hold

5-H

When the timing input is turned ON, the judgment value (P.V.) is held.

■ When "Level" is set for "7. Timing Input" (page 4-23)

The judgment value (P.V.) is held only while the timing input is ON.

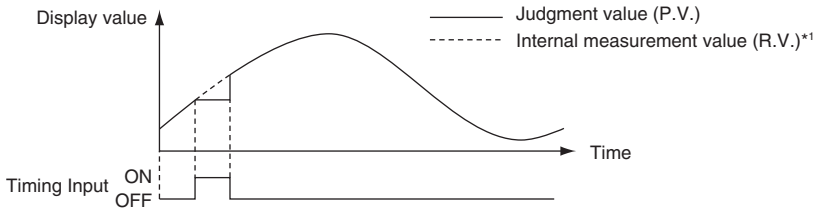

\*1 The main unit (IL-1000/IL-1500) displays the calculation value (CALC value) when the calculation function is used.

📖 "4-3 Calculation Function" (page 4-42)

■ When "Edge" is set for "7. Timing Input" (page 4-23)

The judgment value (P.V.) is held while the timing input is ON.

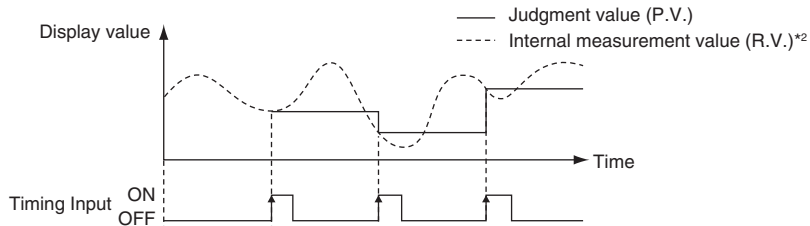

\*1 📖 "11. External Input" (page 4-30)

\*2 The main unit (IL-1000/IL-1500) displays the calculation value (CALC value) when the calculation function is used.

📖 "4-3 Calculation Function" (page 4-42)

Peak hold



The maximum value of the specified period (sampling period) is held as a judgment value (P.V.).

■ When "Level" is set for "7. Timing Input" (page 4-23)

The sampling period is from the falling edge of the timing input to the next rising edge. On the rising edge, the internal measurement value (R.V.) maximized during the sampling period is held as a judgment value. When the timing input is turned OFF, the next sampling period begins.

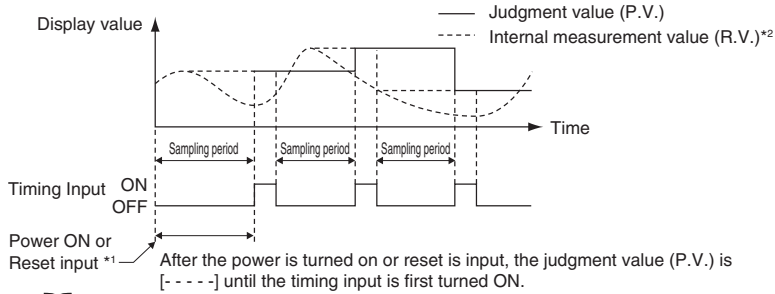

\*1 "11. External Input" (page 4-30)

\*2 The main unit (IL-1000/IL-1500) displays the calculation value (CALC value) when the calculation function is used.

"4-3 Calculation Function" (page 4-42)

\*3 If the R.V. value (or CALC value) causes an alarm even once during the sampling period, the hold results will be "-----".

■ When "Edge" is set for "7. Timing Input" (page 4-23)

The sampling period is from the rising edge of the timing input to the next rising edge of the timing input. On the rising edge, the internal measurement value (R.V.) maximized during the sampling period is held as a judgment value. When the timing input is turned ON, the next sampling period has already begun.

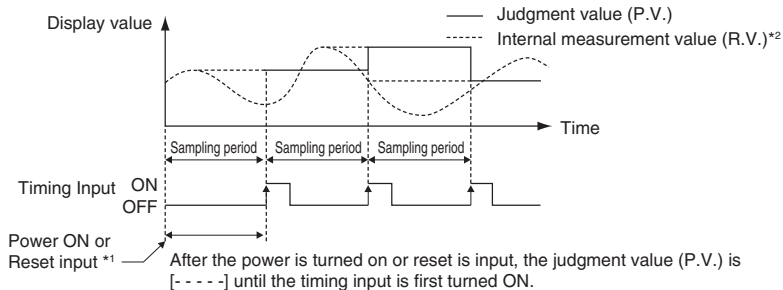

\*1 "11. External Input" (page 4-30)

\*2 The main unit (IL-1000/IL-1500) displays the calculation value (CALC value) when the calculation function is used.

"4-3 Calculation Function" (page 4-42)

\*3 If the R.V. value (or CALC value) causes an alarm even once during the sampling period, the hold results will be "-----".

Bottom hold

b-H

The minimum value of the specified period (sampling period) is held as a judgment value (P.V.).

■ When "Level" is set for "7. Timing Input" (page 4-23)

The sampling period is from the falling edge of the timing input to the next rising edge. On the rising edge, the internal measurement value (R.V.) minimized during the sampling period is held as a judgment value. When the timing input is turned OFF, the next sampling period begins.

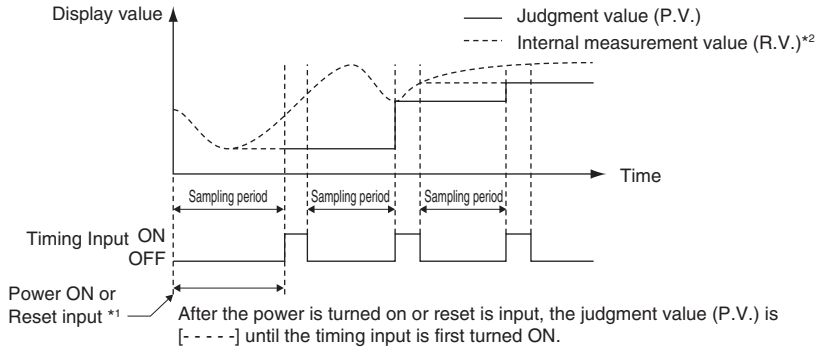

\*1 "11. External Input" (page 4-30)

\*2 The main unit (IL-1000/IL-1500) displays the calculation value (CALC value) when the calculation function is used.

"4-3 Calculation Function" (page 4-42)

\*3 If the R.V. value (or CALC value) causes an alarm even once during the sampling period, the hold results will be "-----".

■ When "Edge" is set for "7. Timing Input" (page 4-23)

The sampling period is from the rising edge of the timing input to the next rising edge of the timing input. On the rising edge, the internal measurement value (R.V.) minimized during the sampling period is held as a judgment value. When the timing input is turned ON, the next sampling period has already begun.

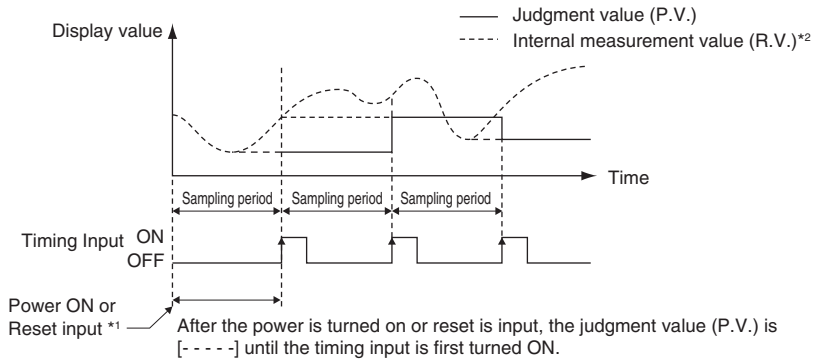

- \*1 "11. External Input" (page 4-30)
- \*2 The main unit (IL-1000/IL-1500) displays the calculation value (CALC value) when the calculation function is used.
- "4-3 Calculation Function" (page 4-42)
- \*3 If the R.V. value (or CALC value) causes an alarm even once during the sampling period, the hold results will be "-----".

## Peak-to-peak hold



The difference between the maximum value and minimum value of the specified period (sampling period) is held as a judgment value (P.V.).

### ■ When "Level" is set for "7. Timing Input" (page 4-23)

The sampling period is from the falling edge of the timing input to the next rising edge. On the rising edge, the difference between the maximum value and minimum value of the internal measurement value (R.V.) during the sampling period is held as a judgment value (P.V.). When the timing input is turned OFF, the next sampling period begins.

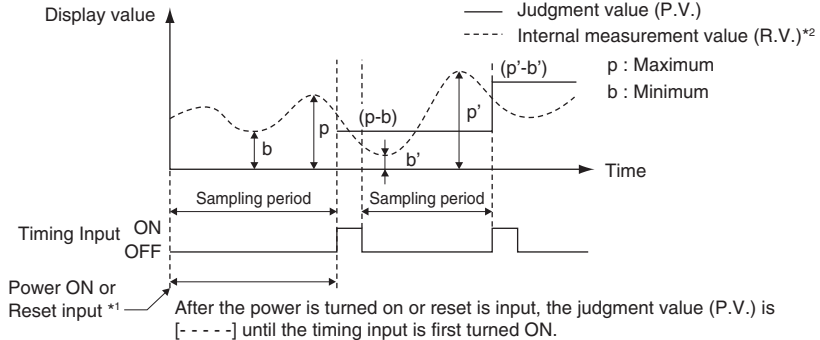

- \*1 "11. External Input" (page 4-30)
- \*2 The main unit (IL-1000/IL-1500) displays the calculation value (CALC value) when the calculation function is used.
- "4-3 Calculation Function" (page 4-42)
- \*3 If the R.V. value (or CALC value) causes an alarm even once during the sampling period, the hold results will be "-----".

■ When "Edge" is set for "7. Timing Input" (page 4-23)

The sampling period is from the rising edge of the timing input to the next rising edge of the timing input. On the rising edge, the difference between the maximum value and minimum value of the internal measurement value (R.V.) during the sampling period is held as a judgment value (P.V.). When the timing input is turned ON, the next sampling period has already begun.

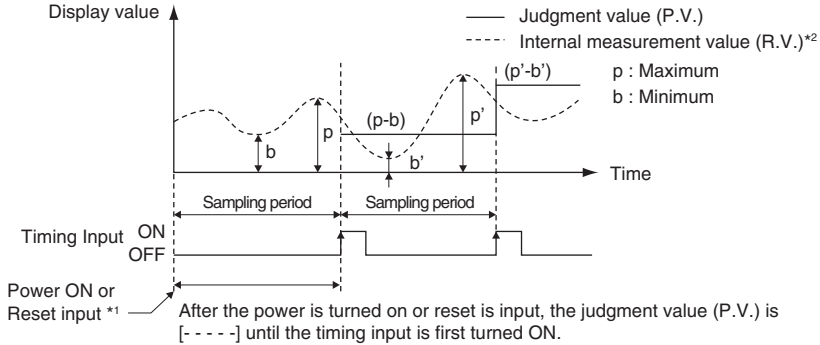

\*1 "11. External Input" (page 4-30)

\*2 The main unit (IL-1000/IL-1500) displays the calculation value (CALC value) when the calculation function is used.

"4-3 Calculation Function" (page 4-42)

\*3 If the R.V. value (or CALC value) causes an alarm even once during the sampling period, the hold results will be "-----".

## Auto peak hold



When the internal measurement value (R.V.) goes beyond the specified trigger level, the sampling begins. When it falls below the trigger level, the sampling finishes. When the sampling finishes, the maximum internal measurement value (R.V.) during the sampling period is held as a judgment value (P.V.).

The external input is not required.

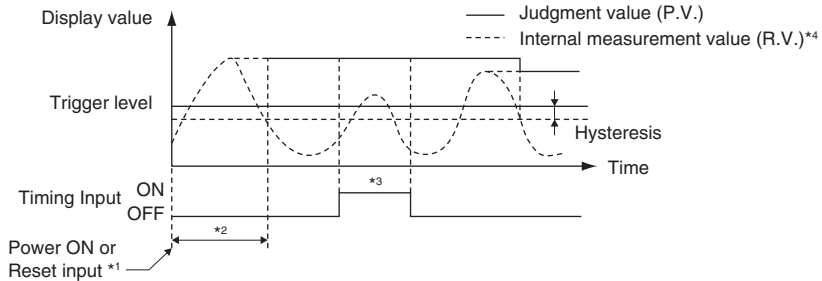

\*1 "11. External Input" (page 4-30)

\*2 After the power is turned on or reset is input, the judgment value (P.V.) is [-----] until the judgment value (P.V.) is first held.

\*3 While the timing input is ON, the sampling does not start. If the sampling is already in process, it continues.

\*4 The main unit (IL-1000/IL-1500) displays the calculation value (CALC value) when the calculation function is used.

"4-3 Calculation Function" (page 4-42)



- The operation by the timing input is the same regardless of the "7. Timing Input" (page 4-23) setting.
- After the sampling starts, if the internal measurement value (R.V.) becomes "-----" before the sampling falls below the specified trigger level, the sampling is automatically finished and the maximized value during the sampling period is held as a judgment value (P.V.).

### ■ Trigger level setting screen

When the auto peak hold is set, the display goes to the trigger level setting screen.

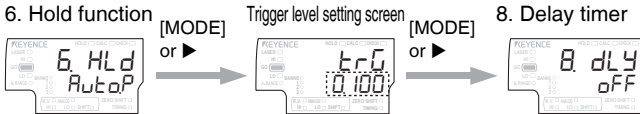

Press ▲ / ▼ button on the trigger level setting screen to specify the trigger level.

#### IL-S025/IL-030/IL-S065/IL-065/IL-100

Item	Setting range	Default value
Trigger level	-99.999 to 99.999	1.000

#### IL-300/IL-600

Item	Setting range	Default value
Trigger level	-999.99 to 999.99	10.00

#### IL-2000

Item	Setting range	Default value
Trigger level	-9999.9 to 9999.9	100.0



The hysteresis presents the same value as the one set for "9. Hysteresis" (page 4-26).

**Auto bottom hold**

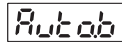

When the internal measurement value (R.V.) falls below the specified trigger level, the sampling begins. When it goes beyond the trigger level, the sampling finishes. When the sampling finishes, the internal measurement value (R.V.) minimized during the sampling period is held as a judgment value (P.V.).  
The external input is not required.

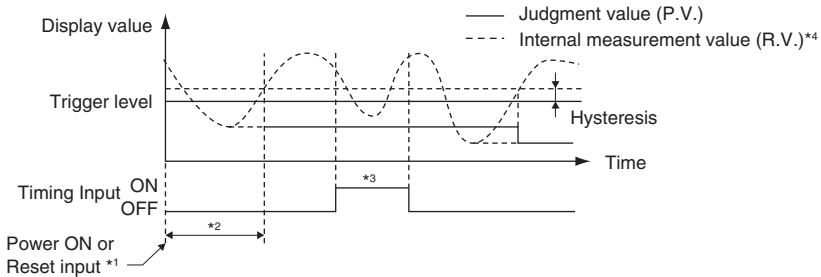

\*1 "11. External Input" (page 4-30)

\*2 After the power is turned on or reset is input, the judgment value (P.V.) is [----] until the judgment value (P.V.) is first held.

\*3 While the timing input is ON, the sampling does not start. If the sampling is already in process, it continues.

\*4 The main unit (IL-1000/IL-1500) displays the calculation value (CALC value) when the calculation function is used.

"4-3 Calculation Function" (page 4-42)



- The operation by the timing input is the same regardless of the "7. Timing Input" (page 4-23) setting.
- After the sampling starts, if the internal measurement value (R.V.) becomes "-----" before the sampling goes beyond the specified trigger level, the sampling is automatically finished and the minimized value during the sampling period is held as a judgment value (P.V.).

■ **Trigger level setting screen**

When the Auto bottom hold is set, the display goes to the trigger level setting screen.

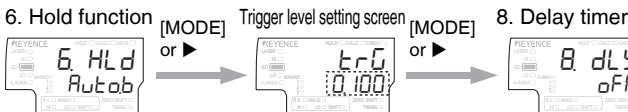

Press ▲ / ▼ button on the trigger level setting screen to specify the trigger level.

**IL-S025/IL-030/IL-S065/IL-065/IL-100**

Item	Setting range	Default value
Trigger level	-99.999 to 99.999	1.000

**IL-300/IL-600**

Item	Setting range	Default value
Trigger level	-999.99 to 999.99	10.00



IL-2000

Item	Setting range	Default value
Trigger level	-9999.9 to 9999.9	100.0



The hysteresis presents the same value as the one set for "9. Hysteresis" (page 4-26).

7. Timing Input

7. t in

The external input (timing input) operation used for "6. Hold Function" (page 4-15) is set. If "Auto peak hold" or "Auto bottom hold" is set, this item is skipped.

Item	Setting range	Default value
Timing Input	LEVEL (Level), EDGE (Edge)	LEVEL

For details, refer to the "6. Hold Function" (page 4-15).

8. Delay Timer

8. dLY

The delay timer for the judgment output is set.

There are three judgment outputs as below.

- HIGH judgment output (Black wire)
- GO judgment output (Gray wire)
- LOW judgment output (White wire)

The judgment output is turned ON/OFF according to the tolerance setting value and the output state settings.

"3-4 Setting the Tolerance Setting Value" (page 3-10)

"5. Output State" (page 4-14)

Delay Timer	Description	Default value
Delay timer off 	The delay timer is not used.	○
ON-delay timer 	Time required to change the GO judgment output operation from OFF to ON is delayed for specified time set on the timer. "ON-delay timer" (page 4-24)	
OFF-delay timer 	Time required to change the GO judgment output operation from ON to OFF is delayed for specified time set on the timer. "OFF-delay timer" (page 4-25)	
1-shot timer 	When GO judgment output is turned ON, if the specified time elapses, GO judgment output is automatically turned OFF. "1-shot timer" (page 4-25)	

Timing chart



- The following are the timing charts when the output state of judgment output is Normally Open (default value). ON/OFF is reversed for Normally Close.
- "5. Output State" (page 4-14)
- The hysteresis is not taken into account in the following timing charts. Note that the hysteresis affects the ON/OFF timing of the actual judgment output.
- "9. Hysteresis" (page 4-26)

■ Delay timer off

The delay timer is not used.

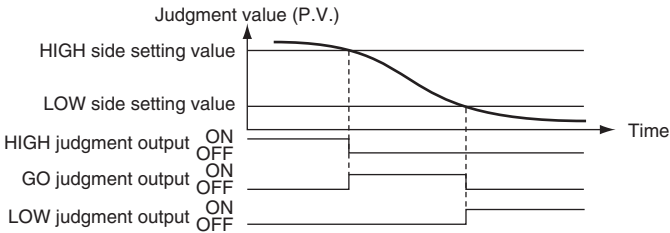

■ ON-delay timer

Time required to change the GO judgment output operation from OFF to ON is delayed for specified time set on the timer. Also, time required to change the HIGH judgment output and LOW judgment output operations from ON to OFF is delayed.

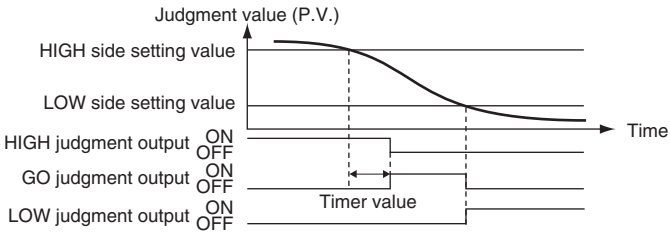

■ OFF-delay timer

Time required to change the GO judgment output operation from ON to OFF is delayed for specified time set on the timer. Also, time required to change the HIGH judgment output and LOW judgment output operations from OFF to ON is delayed.

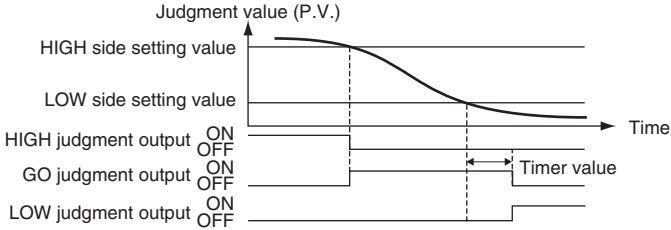

■ 1-shot timer

When the GO judgment output is turned ON, if the specified time set on the timer elapses, the GO judgment output is forcibly turned OFF. The HIGH judgment output and the LOW judgment output are not turned ON.

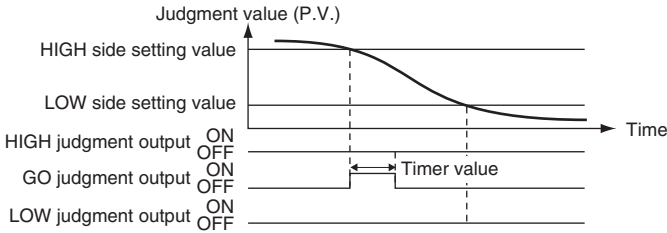

Timer setting screen

When the timer settings other than the Delay timers off are set, the display goes to the timer setting screen. (When the Delay timer off is set, this screen is skipped.)

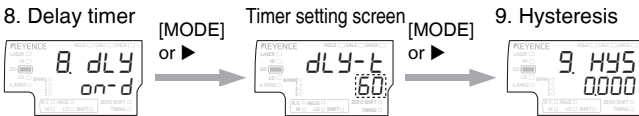

Press ▲ / ▼ button on the timer setting screen to specify the timer.

Item	Setting range	Default value
Timer value	5 to 9999 (ms)	60

## 9. Hysteresis

9.445

The hysteresis for the tolerance setting value is set.

If the judgment value (P.V.) fluctuates due to the vibration of the object, etc. and the judgment output repeats ON/OFF, increasing the hysteresis value stabilizes ON/OFF.

☐ "3-4 Setting the Tolerance Setting Value" (page 3-10)

### IL-S025/IL-030/IL-S065/IL-065/IL-100

Item	Setting range	Default value
Hysteresis	0.000 to 99.999	0.000

### IL-300/IL-600

Item	Setting range	Default value
Hysteresis	0.00 to 999.99	0.00

### IL-2000

Item	Setting range	Default value
Hysteresis	0.0 to 9999.9	0.0

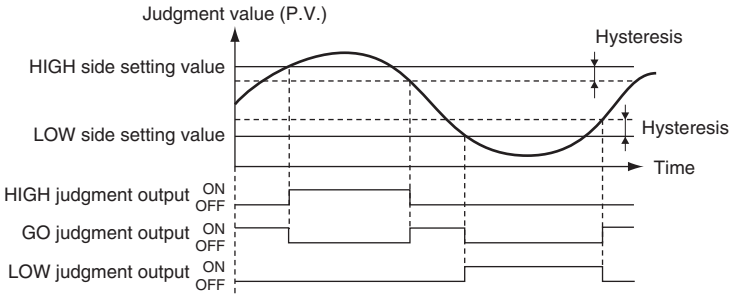

Reference

The above is the timing chart when the output state of judgment output is Normally Open (default value). ON/OFF is reversed for Normally Close.

☐ "5. Output State" (page 4-14)

## 10. Analog Output Scaling

10AN0

The analog output scaling for the judgment value (P.V.) is set.  
If the analog output is set to no output, this screen is skipped.

- "3-1 Operation When the Power is Turned on for the First Time" (page 3-2)
- "3-3 Initial Reset (Initialize)" (page 3-8)

Analog output	Description	Default value
Default setting 	Scaling is not performed.	○
Free range 	Scaling is performed. The analog output range can be changed by specifying the upper limit and lower limit of the judgment value (P.V.).	
Bank 	A different scaling is provided for each bank. The analog output range can be changed by designating an upper limit and lower limit for each bank.	

### Example 1: Lower limit < Upper limit (Analog output 1 to 5 V)

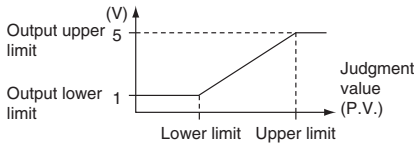

### Example 2: Lower limit > Upper limit (Analog output 1 to 5 V)

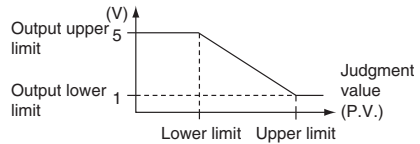

If Upper limit = Lower limit is set, the analog output is output as below.  
Judgment value (P.V.) ≤ Upper limit: Analog output lower limit (When 1 to 5 V → 1 V)  
Judgment value (P.V.) > Upper limit: Analog output upper limit (When 1 to 5 V → 5 V)

### ■ Relation of voltage and analog output in default state (dEFLt)

Model	Upper limit	Lower limit
IL-S025	5.000	- 5.000
IL-030	5.000	- 5.000
IL-S065/IL-065	10.000	- 10.000
IL-100	20.000	- 20.000
IL-300	140.00	- 140.00
IL-600	400.00	- 400.00
IL-2000	1000.0	-1000.0

The upper and lower limits for the different selections of analog outputs are as follows.

Analog setting	Output upper limit	Output lower limit
OFF	Not output	
0-5V	5 V	0 V
-5-5V	5 V	- 5 V
1-5V	5 V	1 V
ANP	20 mA	4 mA

Upper limit setting screen and lower limit setting screen

When set to the default state [dEFLt], the following screens will be skipped.

When set to free range or bank, the upper limit setting and lower limit setting screens will appear.

■ For free range (FrEE)

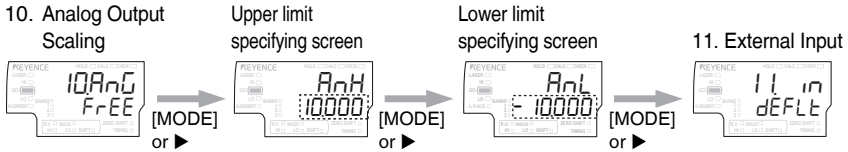

Press ▲ / ▼ button on each setting screen to specify the upper limit and the lower limit.

■ For bank (bAnH)

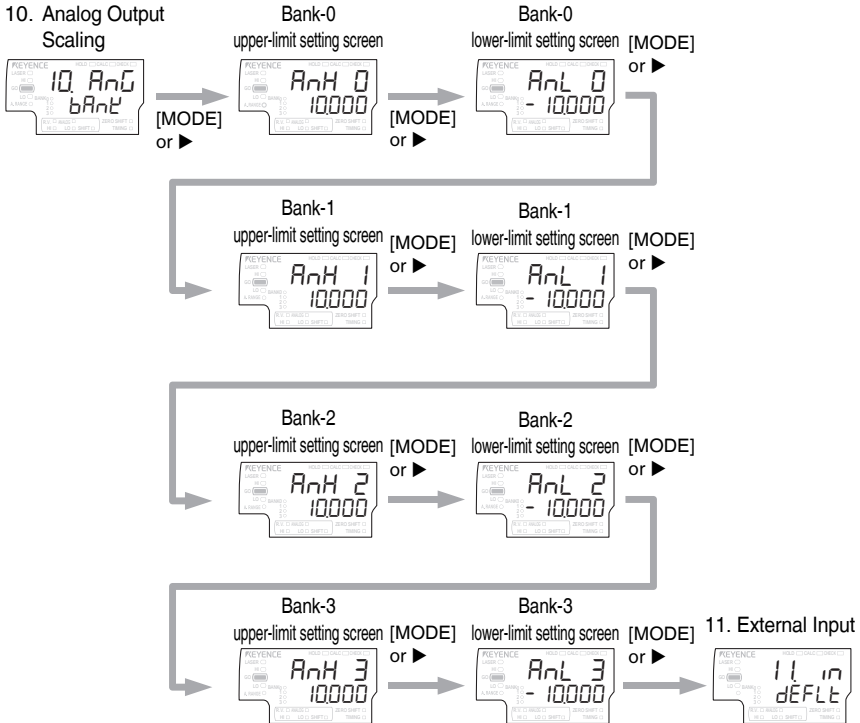

Press ▲/▼ button on each setting screen to specify the upper limit and the lower limit.

### ■ Setting range for analog output scaling

If free range or bank is selected for the analog output scaling state, the upper limit and lower limit can be set within the range shown below.

#### IL-S025/IL-030/IL-S065/IL-065/IL-100

Item	Setting range	Default value
Upper limit	-99.999 to 99.999	10.000
Lower limit	-99.999 to 99.999	-10.000

#### IL-300/IL-600

Item	Setting range	Default value
Upper limit	-999.99 to 999.99	100.00
Lower limit	-999.99 to 999.99	-100.00

#### IL-2000

Item	Setting range	Default value
Upper limit	-9999.9 to 9999.9	1000.0
Lower limit	-9999.9 to 9999.9	-1000.0

## Analog Output Accuracy

The analog output can be selected from  $\pm 5$  V, 1-5 V, 0-5 V or 4-20 mA.

	Voltage output	Current output
Output range	$\pm 5$ V (Full scale 10 V)	4 - 20 mA (Full scale 16 mA)
Output resistance	100 $\Omega$	-
Maximum load resistance	-	350 $\Omega$
Repeatability	$\pm 1$ mV	$\pm 1.5$ $\mu$ A
Accuracy in respect to display	$\pm 0.05\%$ of F.S.	$\pm 0.25\%$ of F.S.
Temperature characteristics	$\pm 0.005\%$ of F.S./ $^{\circ}$ C	$\pm 0.01\%$ of F.S./ $^{\circ}$ C
Refresh rate*1	Same as sensor head sampling rate	

\*1 The averaging is as follows after 512 times.



- 512 times: Sampling rate x 2
- 1024 times: Sampling rate x 4
- 2048 times: Sampling rate x 8
- 4096 times: Sampling rate x 16

## 11. External Input

11 in

You can select functions to be assigned to four external inputs (External input 1 to 4).

☐ "Power/Input-output cable" (page 2-7)

External Input	Description	Default value
Default setting 	Functions for the external inputs remain the same as the factory default setting.	○
User setting 	Functions for the external inputs are changed from the factory default setting.	

### External input setting screen

When the user setting is set, each function of the external input 1 to 4 can be set. Functions that can be set differ for each external input. (When the default is set, these four screens are skipped.)

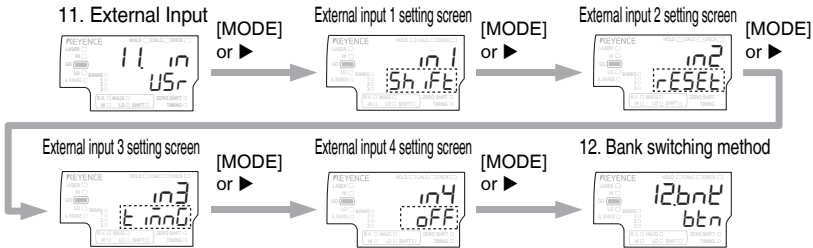

Press ▲ / ▼ button on each setting screen to specify functions.

#### External Input 1 (Pink wire)

Setting value	Description	Default value
Sh iFt	Zero shift input	○
bnk-A	Bank A input	
bnk-b	Bank B input	
L-5tP	Laser emission stop input	
oFF	Not use	

#### External input 3 (Pink/Purple wire)

Setting value	Description	Default value
t inG	Timing Input	○
bnk-A	Bank A input	
bnk-b	Bank B input	
L-oFF	Laser emission stop input	
oFF	Not use	

#### External Input 2 (Yellow wire)

Setting value	Description	Default value
rESEt	Reset input	○
bnk-A	Bank A input	
bnk-b	Bank B input	
L-5tP	Laser emission stop input	
oFF	Not use	

#### External Input 4 (Purple wire)

Setting value	Description	Default value
oFF	Not use	○
bnk-A	Bank A input	
bnk-b	Bank B input	
L-5tP	Laser emission stop input	



When the same function is selected for multiple external inputs, if any are ON, ON (OR operation) works.



## Zero shift input

Shift

When the zero shift input is set to ON, the internal measurement value (R.V.) is shifted (offset) to an arbitrary shift target value.

📖 "3-5 Zero Shift Function (Shifting the Internal Measurement Value (R.V.))" (page 3-18)

### ■ Timing chart

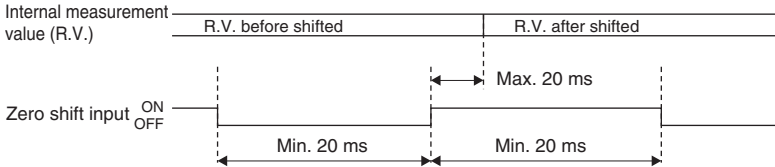

### ■ Minimum Input Time

ON time: 20 ms

OFF time: 20 ms

## Reset input

RESET

When the reset input is turned ON while using the hold function, the judgment value (P.V.) in the held state is canceled and the value becomes [-----].

📖 "6. Hold Function" (page 4-15)

### ■ Timing chart

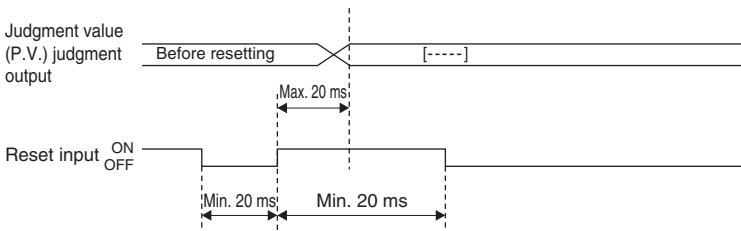

### ■ Minimum Input Time

ON time: 20 ms

OFF time: 20 ms

## Timing Input



When the timing input is turned ON while using the hold function, the judgment value (P.V.) is held.

📖 "6. Hold Function" (page 4-15)

### ■ Timing chart

#### ● When Sample hold is set

##### "7. Timing Input" (page 4-23) setting: "Level"

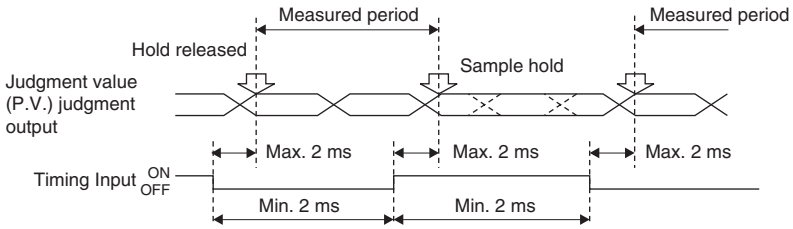

##### "7. Timing Input" (page 4-23) setting: "Edge"

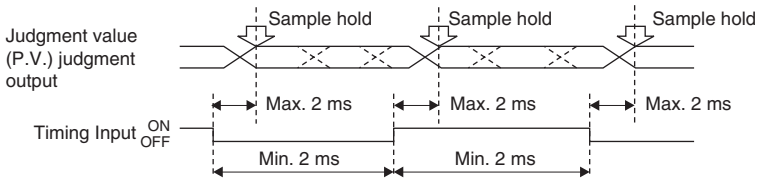

- When Peak hold, Bottom hold or Peak-to-peak hold is set  
**"7. Timing Input" (page 4-23) setting: "Level"**

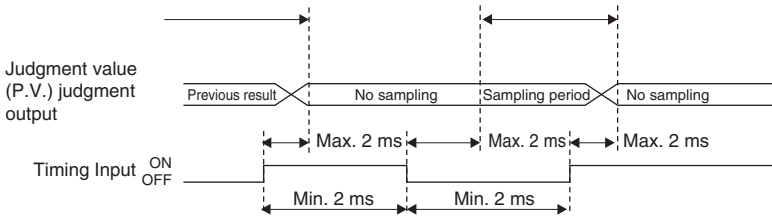

- **"7. Timing Input" (page 4-23) setting: "Edge"**

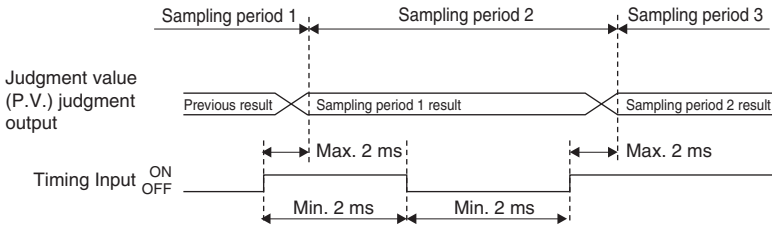

- When Auto peak hold or Auto bottom hold is set

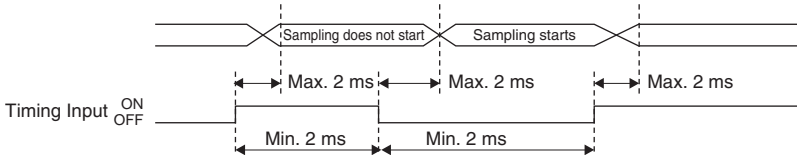

■ **Minimum Input Time**

ON time: 2 ms  
 OFF time: 2 ms

## Bank A input/Bank B input

bnl-A bnl-b

By combining ON/OFF setting of bank A input and bank B input, you can switch the banks.

☞ "3-6 Bank Function (Registering Multiple Tolerance Setting Values)" (page 3-20)

☞ "12. Bank Switching Method" (page 4-35)

### ■ Timing chart

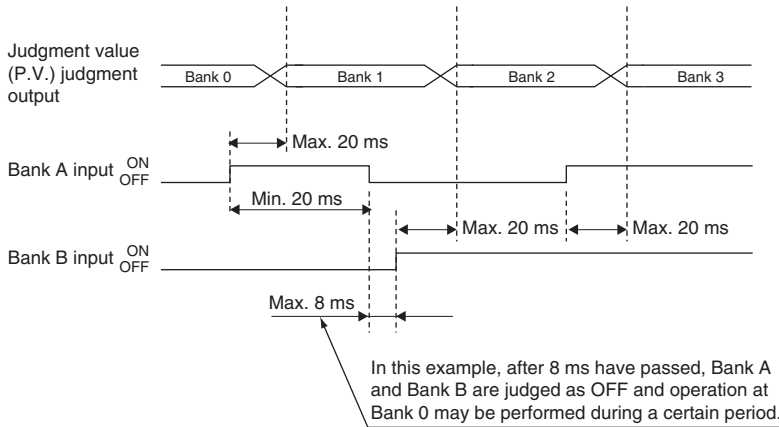

#### Reference

When the judgment value (P.V.) is held using the hold function, the judgment value (P.V.) remains held even if ON/OFF for bank A input or bank B input is switched. However, the judgment output changes according to the setting value set for the new bank.

☞ "6. Hold Function" (page 4-15)

### ■ Minimum Input Time

ON time: 20 ms

OFF time: 20 ms

## Laser emission stop input

L-SEP

The laser emission remains interrupted while the laser emission stop input is ON. The laser emission indicator on the sensor amplifier lights off while the laser emission is stopped.

📖 "Amplifier control unit" (page 1-6)

Reference

Measurements are disabled while the laser emission is stopped. R.V. is determined by the alarm process.

📖 "2 Display Screen and Output" (page A-8)

### ■ Timing chart

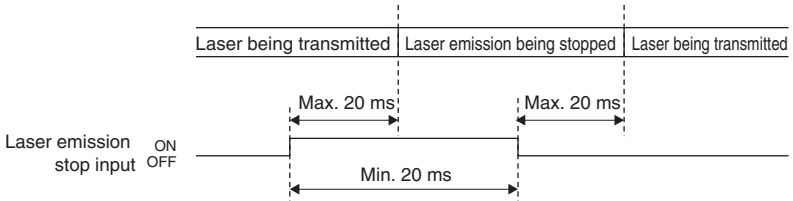

### ■ Minimum Input Time

ON time: 2 ms

OFF time: 2 ms

## 12. Bank Switching Method

12bnE

Set whether to switch the bank with the amplifier buttons or with external inputs.

Setting	Description	Default value
Switching with buttons bn	The banks are switched by operating the amplifier buttons.	○
Switching with external input in	The banks are switched only by turning ON/OFF the bank A input or bank B input set in "11. External input".	

\* If switching with buttons is selected, the bank can be switched only with the buttons. If switching with external input is selected, the bank can be switched only from the external input cable.

### Switching the bank with button operations

Press the ▲/▼ button while holding down the [MODE] button on the main screen. The bank will switch, and the bank indicator [BANK0 to 3] will light according to the selected bank.

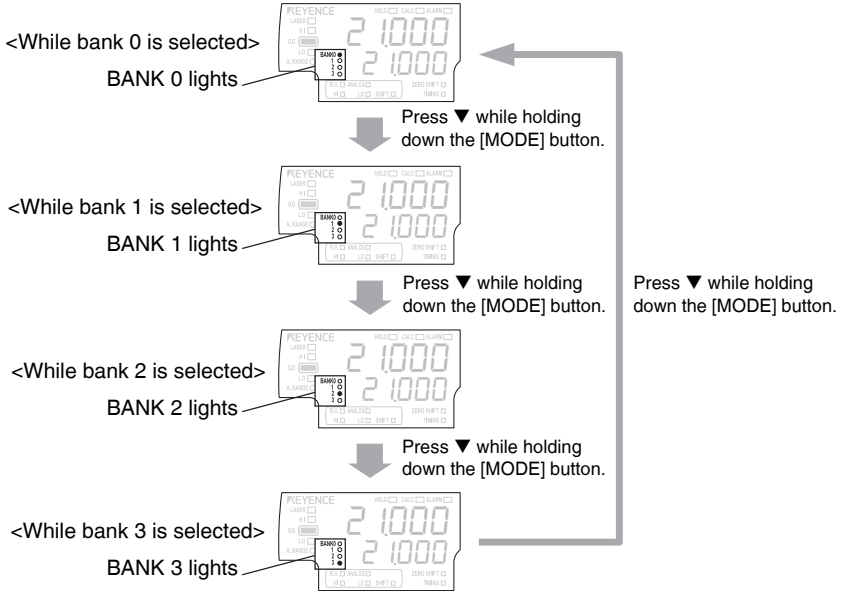

**Reference**

- If the ▲ button is pressed while holding down the [MODE] button, the banks will change in the reverse direction.
- The banks cannot be switched with buttons if the bank switching method is set to external input. If the banks are switched with buttons, the following is displayed.



## Switching the bank by the external input

When the Bank A input and Bank B input are set for the external inputs, the bank can be switched using the external inputs.

📖 "11. External Input" (page 4-30)

📖 "12. Bank Switching Method" (page 4-35)

### 1 The banks are switched with the ON/OFF combination of the bank A input and bank B input.

- The bank input must be held 20 ms or longer.

📖 "11. External Input" (page 4-30)

- The combinations of bank A input and bank B input are shown in the following table.

Bank	Bank A input	Bank B input
Bank 0	OFF	OFF
Bank 1	ON	OFF
Bank 2	OFF	ON
Bank 3	ON	ON

ON : Short-circuited

OFF: Open



If the external input is not set to bank A or bank B, it is regarded as OFF.  
(Example) If only Bank A input is set for the external input, only two patterns (bank 0 and bank 1) can be switched using the external input.

### 2 The bank switching method is switched from button input to external input.

📖 "12. Bank Switching Method" (page 4-35)

### 13. Zero Shift Value Memory Function

135FE

When the zero shift is performed with the external input, make the setting for the nonvolatile memory (EEPROM) to save the shifted status.

When the zero shift is performed with the sensor amplifier button operation, it is saved on the nonvolatile memory (EEPROM) regardless of the setting.

☞ "3-5 Zero Shift Function (Shifting the Internal Measurement Value (R.V.))" (page 3-18)

 Point

**If the data is written in the nonvolatile memory (EEPROM) over 1 million times, the error message is displayed and the setting may not be saved any more. (It is still possible to obtain a measurement value.)**

☞ "Error Displays and Corrective Actions" (page A-4)

**For such cases as the zero shift occurring frequently from the PLC, and, it is not necessary to store it in the nonvolatile memory (EEPROM), it is recommended to set it as OFF.**

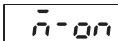
Saving the Standard Waveform	Description	Default value
OFF 	Not save on the nonvolatile memory (EEPROM)	○
ON 	Save on the nonvolatile memory (EEPROM)	

### 14. Interference Prevention Function (Only for IL-1000/1500)

14.0nF

This function allows the amplifier to prevent the mutual interference caused by light interaction between sensor heads.

If the "mutual-interference prevention function setting" is ON, the function is effective between adjacent amplifiers.

When set to OFF, the laser emission timing is synchronized if the sampling rate is the same within "(number of amplifiers - 1) x 5 μs".

☞ "3. Averaging rate, Step count filter, High-pass filter" (page 4-9)

When the expansion units are not installed, this screen is skipped.



 Point

- If the data between the heads is not synchronized when using the calculation function or when the DL series is connected, disable the mutual-interference prevention function and set the main unit's sampling rate to a rate other than 0.33 ms. When the mutual-interference prevention function is enabled, or 0.33 ms is set, the timing for updating the main unit and expansion unit's internal data will not match. In this case, when measuring a moving target using the calculation function, the measured value may greatly differ from the actual value.
  - The timing cannot be synchronized for the following time after the power has been turned ON and after the interference prevention setting has been changed.
    - When sampling rate is 0.33 ms/1 ms/2 ms : 3 seconds
    - When sampling rate is 5 ms : 15 seconds
-  "4-3 Calculation Function" (page 4-42)
- The screen is skipped if the sampling rate is set to 2 ms or 5 ms for IL-S025/IL-030/IL-S065/IL-065/IL-100, and  $dEFLt$ , 2 ms or 5 is set for IL-300/IL-600/IL-2000.
  - Skipped if there is no expansion unit or if expansion unit 1 is not an IL Series unit.
  - For those items with even one amplifier included and shipped before December 21th, 2010, when the "3.AVE" settings of the main unit are  $[dFF]/[HPF]$ , the screen will be skipped.

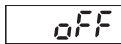
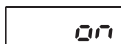
Interference prevention	Description	Default value
OFF 	Interference prevention function OFF	<input type="radio"/>
ON 	Interference prevention function ON	<input type="checkbox"/>

\* When the mutual-interference prevention function is ON, the expansion unit's sampling rate and number of average times are the same as the main unit settings.

## 15. Display Digit

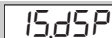

The number of digits of the judgment value (P.V.), the internal measurement value (R.V.) or the calculation value (CALC value) displayed on the sensor amplifier is set.

Display Digit	Description	Default value
$dEFLt$	A different value is displayed for each head.*1	<input type="radio"/>
0.00 I	3 decimal places*2 *3	
0.0 I	Truncate the 3rd decimal place*3	
0. I	Truncate the 2nd decimal place	
I	Truncate the 1st decimal place	

\*1 The 7 segment inscription of  $[dEFLt]$  is IL-S025/IL-030/IL-S065/IL-065/IL-100: 0.01, IL-300/IL-600: 0.1, and IL-2000: 1.

\*2 This cannot be set under IL-300/IL-600/IL-2000.



\*3 This cannot be set under IL-2000.

## 16. Power Saving Function

16Eco

When no buttons are pressed for more than one minute, the power saving function is activated with the sensor amplifier.

The power saving function is activated as soon as the setting is complete. The normal display is restored by pressing any of the buttons.

Power save function	Sensor Amplifier	Default value
OFF 	Normally ON	○
Half 	Animation display*1	
All 	All OFF	



\*1 Only one segment (horizontal bar in the center) on the main display (upper) flashes, moving in order on the display from right to left. Also, the sub display indicator turns off.



## 17. Head Display Mode

17HEd

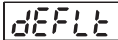
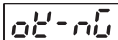
The display status of the sensor head is set.

Head display mode	Item	Description	Default value
Normal display mode 	(1) Reference distance indicator	Lights near the center of the measurement range.	○
	(2) Analog range indicator	Lights when in the range of the analog output.*1	
	(3) Laser radiation emission indicator	Lights while the laser is being emitted, and blinks when stopped.	
Judgment status display mode 	(1) Reference distance indicator	During GO judgment: Green LED turns ON*2 During HI, LOW, Err: Red LED turns ON*2 Judgment standby status: OFF	
	(2) Analog range indicator	Always OFF	
	(3) Laser radiation emission indicator	Lights while the laser is being emitted, and blinks when stopped.	
OFF 	(1) Reference distance indicator	Always OFF	
	(2) Analog range indicator	Always OFF	
	(3) Laser radiation emission indicator	Lights while the laser is being emitted, and blinks when stopped.	

Near measurement center  
 IL-S025 : 25 mm ± 0.25 mm  
 IL-030 : 30 mm ± 0.25 mm  
 IL-S065/IL-065 : 65 mm ± 0.5 mm  
 IL-100 : 100 mm ± 1 mm  
 IL-300 : 300 mm ± 7 mm  
 IL-600 : 600 mm ± 20 mm  
 IL-2000: 2000 mm ± 50 mm

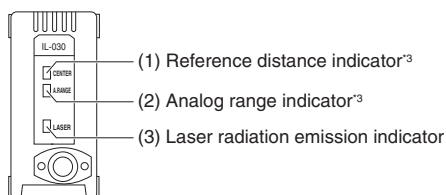

- \*1 When the analog output of the main unit is set to OFF, or the expansion unit is operating, the indicator turns on if the following distances are detected.  
 IL-S025: 25 ± 5 mm  
 IL-030: 30 ± 5 mm  
 IL-S065/IL-065: 65 ± 10 mm  
 IL-100: 100 ± 20 mm  
 IL-300: 300 ± 140 mm  
 IL-600: 600 ± 400 mm  
 IL-2000: 2000 mm ± 1000 mm
- \*2 If GO is set to red with "18. Display color", the green LED and red LED lighting methods will be reversed.
- \*3 The position of the display light (CENTER/A.RANGE) of the IL-S025/IL-S065/IL-2000 is different from that of above.

## 18. Display Color

18Col

The LED color of the judgment indicator is set. The display color for the main display (upper part) can be set at the same time only for the panel mount type amplifier (IL-1500/IL-1550).

📖 "3-4 Setting the Tolerance Setting Value" (page 3-10)

Display color	DIN rail mount type (IL-1000/1050)	Panel mount type (IL-1500/IL-1550)		Default value
	Judgment indicator	Judgment indicator	Main display	
GO Green 	HI: Red GO: Green LO: Red	HI: Red GO: Green LO: Red	GO: Green, otherwise: Red	○
GO Red 	HI: Green GO: Red LO: Green	HI: Green GO: Red LO: Green	GO: Red, otherwise: Green	
Always Red 	HI: Red GO: Red LO: Red	HI: Red GO: Red LO: Red	Always Red display	

The internal measurement value (R.V.) for the "main unit" and the "expansion unit additionally installed next to the main unit (referred to as expansion unit 1)" can be calculated (addition or subtraction).

If there is more than one expansion unit, the calculation function can be used between the "main unit" and the "expansion unit 1" only.

There are two calculation modes for the calculation function.

- Addition Mode
- Subtraction Mode

 Point

1. When using the calculation function, the setting of the averaging of expansion unit and sampling rate will be changed to the same setting as the main unit.
2. If the sampling rate is set to 0.33 ms or if the interference prevention function is ON, the timing for updating the main unit and expansion unit's internal data will not match. In this case, when measuring a moving target using the calculation function, the measured value may be greatly differ from the actual value.



### Calculation Value (CALC value)

The calculation result of the internal measurement value (R.V.) for the "main unit" and the "expansion unit 1" is referred to as calculation value (CALC value).

The "main unit" operates with the calculation value (CALC value) considered as a judgment value (P.V.).

The "expansion unit 1" operates with its internal measurement value (R.V.) considered as a judgment value (P.V.).

 Reference

- The calculation value (CALC value) can be displayed on the sub display (lower level) on the main unit.
  -  "Sub Display (Lower Level)" (page 3-4)
- When the hold function is used, the calculation value (CALC value) is not held.
  -  "6. Hold Function" (page 4-15)

The calculation function cannot be used when a mixture of units from the following groups is used: IL-S025/IL-030/IL-S065/IL-065/IL-100, IL-300/IL-600, and IL-2000.

The calculation function can be used when a combination of units from within each of the following groups is used: IL-S025/IL-030/IL-S065/IL-065/IL-100 and IL-300/IL-600. The calculation function can also be used when multiple IL-2000s are used in combination.

## Addition Mode

In the addition mode, the added value of the internal measurement value (R.V.) for the "main unit (A)" and the "expansion unit 1 (B)" is considered as the calculation value (CALC value).

$$\text{Calculation value} = (\text{A's R.V.}) + (\text{B's R.V.})$$

The thickness or width of a large object that cannot be measured with the measurement range of one sensor head can be measured.

### Setting example 1

Head connected to main unit (A)

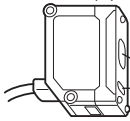

Head connected to main unit (B)

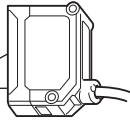

Workpiece

If the zero shift function is used, the actual diameter or width of the object can be displayed as a calculation value (CALC value).

☐ "3-5 Zero Shift Function (Shifting the Internal Measurement Value (R.V.))" (page 3-18)

## Subtraction Mode

In the subtraction mode, the value obtained by subtracting the internal measurement value (R.V.) for the "expansion unit 1 (B)" from the internal measurement value (R.V.) for the "main unit (A)" is considered as the calculation value (CALC value).

$$\text{Calculation value} = (\text{A's R.V.}) - (\text{B's R.V.})$$

### Setting example 1

Head connected to main unit (B)

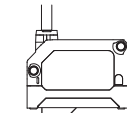

Head connected to expansion unit (A)

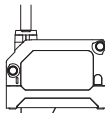

If the zero shift function is used, the actual levels of the object can be displayed as a judgment value (P.V.).

☐ "3-5 Zero Shift Function (Shifting the Internal Measurement Value (R.V.))" (page 3-18)

Setting Method (Only Main Unit)

Main screen



Press [MODE] + ◀ button 2 seconds or more at the same time

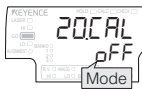

[MODE] or ▶ button



[MODE] or ▶ button



Main screen



**1** Press [MODE] button and ◀ button for approx. 2 seconds on the main screen at the same time.

[20.CAL] is displayed on the main display (upper level).

**2** Press ▲ / ▼ button to set the mode and press [MODE] or ▶ button.

Setting value	Description	Default value
OFF	The calculation function is not used.	○
PLUS	Addition Mode	
MINUS	Subtraction Mode	

If there is no expansion unit additionally installed, the setting cannot be changed from [OFF].

**3** [End] blinks on the sub display (lower level). When the settings are finished with [MODE] or the ▶ button, the main screen is restored.

**4** When settings other than "The calculation function is not used" are set on the main screen, the calculation indicator "CALC" lights up.

## Setting method (Calibrating R.V.)

When there is a difference between the internal measurement value (R.V.) and the actual dimension of the object, the value can be calibrated. The zero point (offset) and tilt are both corrected.

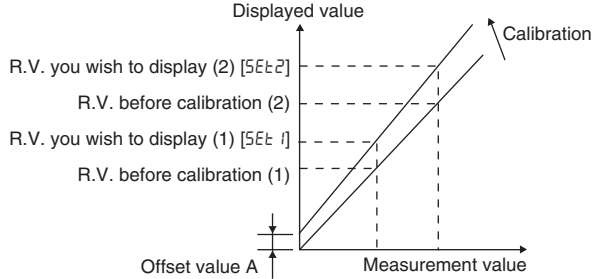

**! Point**

- If the following conditions are not satisfied, the screen below is displayed when the setting is complete. Make the setting again.



- $0.5 \leq \frac{(\text{R.V. you wish to display (2)}) - (\text{R.V. you wish to display (1)})}{(\text{R.V. before calibration (2)}) - (\text{R.V. before calibration (1)})} \leq 2$
- Workpiece is not within measurement range.
- The setting was switched during the calibration.

### When calculation function is disabled

Main screen



Press [MODE] +

▶ button  
2 seconds or more  
at the same time



Calibration setting



**1** Press [MODE] button and ▶ button for approx. 2 seconds on the main screen at the same time.

[30 CLb] is displayed on the main display (upper level).

**2** Press ▲ / ▼ button to set [USr] and press ▶ button.

Setting value	Description	Default value
dEFLt	Standard	○
USr	User setting	

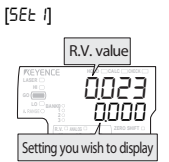

[SET] button

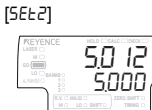

[SET] button

4

Setting Various Functions

3

Insert workpiece A for which the measured value is known, and using the ▲ / ▼ buttons, set the "R.V. you wish to display (1)" for that workpiece A.

The current internal measurement value is displayed on the main display (upper level). [SEt 1] and the "R.V. you wish to display (1)" are alternately displayed on the sub display (lower level).

IL-S025/IL-030/IL-S065/IL-065/IL-100

Item	Setting range	Default value
SEt 1	-99.999 to 99.999	0.000

IL-300/IL-600

Item	Setting range	Default value
SEt 1	-999.99 to 999.99	0.00

IL-2000

Item	Setting range	Default value
SEt 1	-9999.9 to 9999.9	0.0

4

Press the [SET] button. (SET1 confirmation operation)

After [SEt 1] blinks several times on the sub display (lower level), [SEt 2] is displayed.

5

Insert workpiece B for which the measured value is known, and using the ▲ / ▼ buttons, set the "R.V. you wish to display (2)" for that workpiece B.

The current internal measurement value is displayed on the main display (upper level). [SEt 2] and the "R.V. you wish to display (2)" are alternately displayed on the sub display (lower level).

IL-S025/IL-030/IL-S065/IL-065/IL-100

Item	Setting range	Default value
SEt 2	-99.999 to 99.999	5.000

IL-300/IL-600

Item	Setting range	Default value
SEt 2	-999.99 to 999.99	50.00

IL-2000

Item	Setting range	Default value
SEt 2	-9999.9 to 9999.9	500.0





▶ button

Main screen

## 6 Press the [SET] button. (SET2 confirmation operation)

After [SEt2] blinks several times on the sub display (lower level), [End] blinks.

This completes the calibration.

## 7 Press the ▶ button.

The main screen is restored.

### When using the calculation function

Main screen



Press [MODE] +

▶ button

2 seconds or more at the same time

## 1 Press [MODE] button and ▶ button for approx. 2 seconds on the main screen at the same time.

[CAL] is displayed on the main display (upper level).

## 2 Press ▲ / ▼ button to set [HERd] and press ▶ button.

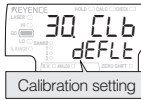

Calibration setting



▶ button

Setting value	Description
HERd	The internal measurement value (R.V.) calibration is set.
CALc	The calculated value (CALC) calibration is set.

Go to Step 2 of "When calibration function is disabled".

### Setting method (Two-point calibration of calculated value (CALC value))

When there is a difference between the calculated value (CALC value) and the actual dimension of the object, the value can be corrected.  
Both the zero point (offset) and tilt (span) are corrected.

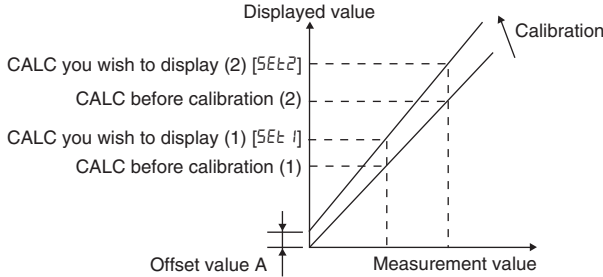

**! Point**

- If the following conditions are not satisfied, the screen below is displayed when the setting is complete. Make the setting again.



- $0.5 \leq \frac{(\text{CALC you wish to display (2)}) - (\text{CALC you wish to display (1)})}{(\text{CALC before calibration (2)}) - (\text{CALC before calibration (1)})} \leq 2$
- Workpiece is not within measurement range.
- The setting was changed during the calibration.

Main screen



Press [MODE] + **▶** button 2 seconds or more at the same time



Calculation calibration setting



**1** Press [MODE] button and **▶** button for approx. 2 seconds on the main screen at the same time.

[CAL ib] is displayed on the main display (upper level).

**2** Press **▲ / ▼** button to set [CAL ib] and press **▶** button.

Setting value	Description
HEAD	The internal measurement value (R.V.) calibration is set.
CALC	The calculated value (CALC) calibration is set.

**3** Press **▲ / ▼** button to set [USr 2P] and press **▶** button.

Setting value	Description	Default value
dEFLt	Standard	○
USr 2P	User setting (Two-point calibration)	
USr 3P	User setting (Three-point calibration)	



#### 4 Insert workpiece A for which the measured value is known, and using the ▲ / ▼ buttons, set the "CALC you wish to display (1)" for that workpiece A.

The current internal measurement value is displayed on the main display (upper level). [5Et 1] and the "CALC you wish to display (1)" are alternately displayed on the sub display (lower level).

IL-S025/IL-030/IL-S065/IL-065/IL-100

Item	Setting range	Default value
5Et 1	-99.999 to 99.999	5.000

IL-300/IL-600

Item	Setting range	Default value
5Et 1	-999.99 to 999.99	50.00

IL-2000

Item	Setting range	Default value
5Et 1	-9999.9 to 9999.9	500.0

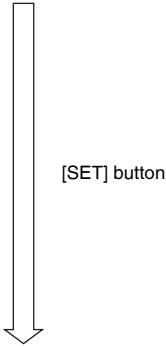

[5Et 1]

#### 5 Press the [SET] button. (SET1 confirmation operation)

After [5Et 1] blinks several times on the sub display (lower level), [5Et2] is displayed.

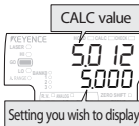

[5Et2]

#### 6 Insert workpiece B for which the measured value is known, and using the ▲ / ▼ buttons, set the "CALC you wish to display (2)" for that workpiece B.

The current internal measurement value is displayed on the main display (upper level). [5Et2] and the "CALC you wish to display (2)" are alternately displayed on the sub display (lower level).

IL-S025/IL-030/IL-S065/IL-065/IL-100

Item	Setting range	Default value
5Et2	-99.999 to 99.999	10.000

IL-300/IL-600

Item	Setting range	Default value
5Et2	-999.99 to 999.99	100.00

IL-2000

Item	Setting range	Default value
5Et2	-9999.9 to 9999.9	1000.0

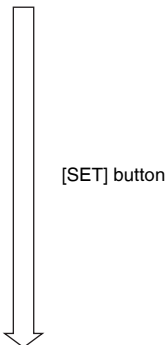

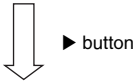

Main screen

### 7 Press the [SET] button. (SET2 confirmation operation)

After [5E $\pm$ 2] blinks several times on the sub display (lower level), [End] blinks.

This completes the calibration.

### 8 Press the ► button.

The main screen is restored.

## 4

### Setting method (Three-point calibration of calculated value (CALC value))

When there is a difference between the calculated value (CALC value) and the actual dimension of the object, the value can be corrected.

With two-point calibration of the calculated value (CALC value), the zero point (offset) and tilt (span) of the calculated value are corrected, but with three-point calibration of the calculated value (CALC value), the tilt (span) of the main unit's internal measurement value (R.V.) is calibrated with the zero point (offset) and tilt (span) of the calculated value. Even when measuring the same workpiece, an error may result in the measurement position. This error can be calibrated with three-point calibration.



Point

- Move the same workpiece between the 1st point and 2nd point.
- If the following conditions are not satisfied, the screen below is displayed when the setting is complete. Make the setting again.



$$0.5 \leq \frac{(\text{CALC you wish to display (3)}) - (\text{CALC you wish to display (1)})}{(\text{CALC before calibration (3)}) - (\text{CALC before calibration (1)})} \leq 2$$

•Addition

$$0.5 \leq \frac{-(\text{R.V. of expansion unit at 2nd point} - \text{R.V. of expansion unit at 1st point})}{(\text{R.V. of main unit at 2nd point before calibration}) - (\text{R.V. of main unit at 1st point before calibration})} \leq 2$$

•Subtraction

$$0.5 \leq \frac{\text{R.V. of expansion unit at 2nd point} - \text{R.V. of expansion unit at 1st point}}{(\text{R.V. of main unit at 2nd point before calibration}) - (\text{R.V. of main unit at 1st point before calibration})} \leq 2$$

- Workpiece is not within measurement range.
- The setting was switched during the calibration.
- Workpieces inserted at the 1st point and 2nd point are different.
- When three-point calibration is performed, the main unit's internal measurement value (R.V.) is calibrated. Thus, the calibration settings for the main unit's head are automatically changed to [L5r].

Main screen



Press [MODE] +  $\blacktriangleright$  button  
2 seconds or more  
at the same time



[SET] button  
[SEt I]

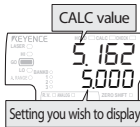

[SET] button

**1** Press [MODE] button and  $\blacktriangleright$  button for approx. 2 seconds on the main screen at the same time.

[CAL Ib] is displayed on the main display (upper level).

**2** Press  $\blacktriangle$  /  $\blacktriangledown$  button to set [CALc] and press  $\blacktriangleright$  button.

Setting value	Description
HEAD	The internal measurement value (R.V.) calibration is set.
CALc	The calculated value (CALC) calibration is set.

**3** Press  $\blacktriangle$  /  $\blacktriangledown$  button to set [USr. 3P] and press  $\blacktriangleright$  button.

Setting value	Description	Default value
dFLt	Standard	○
USr. 2P	User setting (Two-point calibration)	
USr. 3P	User setting (Three-point calibration)	

**4** Workpiece A is set closer to the head connected to the main unit allowing for the possible workpiece positional deviation. Then set the "CALC value you wish to display (1)" for that workpiece A by  $\blacktriangle$  /  $\blacktriangledown$  buttons.

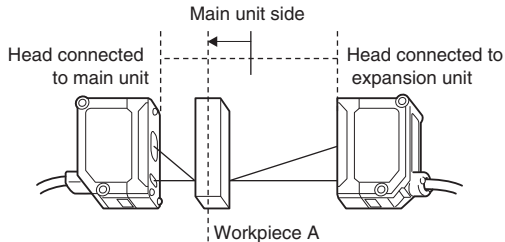

The current internal measurement value is displayed on the main display (upper level). [SEt I] and the "CALC you wish to display (1)" are alternately displayed on the sub display (lower level).

IL-S025/IL-030/IL-S065/IL-065/IL-100

Item	Setting range	Default value
SEt I	-99.999 to 99.999	5.000

IL-300/IL-600

Item	Setting range	Default value
SEt I	-999.99 to 999.99	50.00

IL-2000

Item	Setting range	Default value
SEt I	-9999.9 to 9999.9	500.0

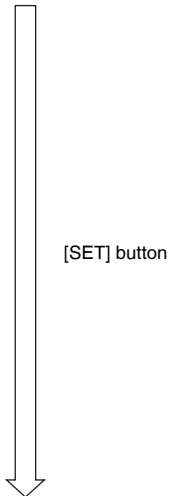
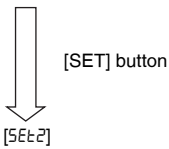

**5** Press the [SET] button. (SET1 confirmation operation)

After [5E±2] blinks several times on the sub display (lower level), [5E±2] is displayed.

**6** Workpiece A is set closer to the head connected to the expansion unit allowing for the possible workpiece positional deviation.

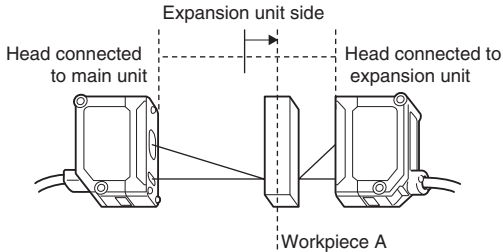

The current internal measurement value is displayed on the main display (upper level). [5E±2] and the "CALC you wish to display (2)" are alternately displayed on the sub display (lower level). The "CALC value you wish to display (2)" cannot be set. The same value of "CALC value you wish to display (1)" is displayed.

**!** Point

The same workpiece as point 1 is moved.

**7** Press the [SET] button. (SET2 confirmation operation)

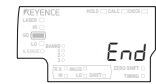
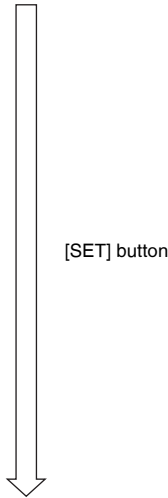
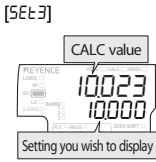

**8** Insert workpiece B for which the measured value is known, and using the ▲ / ▼ buttons, set the "CALC you wish to display (3)" for that workpiece B.

Head connected to main unit      Head connected to expansion unit

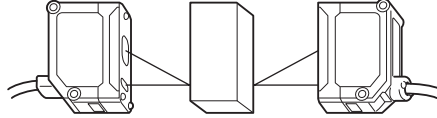

Workpiece B

The current internal measurement value is displayed on the main display (upper level). [5Et3] and the "CALC you wish to display (3)" are alternately displayed on the sub display (lower level).

**IL-S025/IL-030/IL-S065/IL-065/IL-100**

Item	Setting range	Default value
5Et3	-99.999 to 99.999	10.000

**IL-300/IL-600**

Item	Setting range	Default value
5Et3	-999.99 to 999.99	100.00

**IL-2000**

Item	Setting range	Default value
5Et3	-9999.9 to 9999.9	1000.0

**9** Press the [SET] button. (SET3 confirmation operation)

After [5Et3] blinks several times on the sub display (lower level), [End] is displayed.

This completes the calibration.

**10** Press the ▶ button.

The main screen is restored.

MEMO

4

Setting Various Functions



---

# Specifications

# 5

This chapter describes the specifications, circuit diagrams, and dimensions of the IL Series.

<b>5-1</b>	<b>Specifications .....</b>	<b>5-2</b>
<b>5-2</b>	<b>Circuit Diagram.....</b>	<b>5-5</b>
<b>5-3</b>	<b>Dimensions.....</b>	<b>5-7</b>
<b>5-4</b>	<b>Response Time .....</b>	<b>5-18</b>

# 5-1 Specifications

## Sensor Head

Model	IL-S025	IL-S065
Mounting distance	25 mm	65 mm
Measurement range	20 to 30 mm	55 to 75 mm
Light source	Red semiconductor laser; wavelength 655 nm (visible light)	
	Laser Class	Class 2 (FDA CDRH Part1040.10 <sup>-1</sup> , IEC 60825-1: 2014)
	Output	560 μW
Spot diameter (at the reference distance)	Approx. 25 x 1200 μm	Approx. 55 x 1700 μm
Linearity <sup>*2 *3</sup>	±0.075% of F.S. (When used under 20 to 25 mm)	±0.05% of F.S. (When used under 55 to 65 mm)
	±0.1% of F.S. (When used under 20 to 30 mm)	±0.075% of F.S. (When used under 55 to 75 mm)
Repeatability <sup>*4</sup>	1 μm	2 μm
Sampling rate	0.33/1/2/5 ms (Variable to 4 levels)	
Operating indicators	Laser emission warning indicator: green LED, Analog range indicator: orange LED, Reference distance indicator: red/green LED	
Temperature characteristic <sup>*3</sup>	0.03% of F.S./°C	0.02% of F.S./°C
Environmental resistance	Enclosure rating	IP67
	Ambient light <sup>*5</sup>	Incandescent lamp: 10000 lx
	Ambient temperature	-10 to + 50°C (No condensation and freezing)
	Relative humidity	35 to 85% RH (No condensation)
	Vibration	10 to 55 Hz, 1.5 mm double amplitude, 2 hours each for X, Y, and Z axes
Pollution degree	3	
Material	Housing material: PBT, Metal: SUS304, Packing: NBR, Lens cover: Glass, Cable: PVC	
Weight	Approx. 60 g	Approx. 75 g

\*1 The classification is implemented based on IEC60825-1 following the requirement of Laser Notice of FDA (CDRH).

\*2 Value when measuring the KEYENCE standard target (white diffuse object).

\*3 The F.S. of all of the models are as follows. IL-S025: ±5 mm, IL-S065: ±10 mm

\*4 Is the value for when our standard object (white diffuse object) is measured at an average of 128 times and with a sampling rate of 1 ms from a standard distance.

\*5 Value when the sampling rate is set to 2 ms or 5 ms.

Model	IL-030	IL-065	IL-100	IL-300	IL-600	IL-2000
Mounting distance	30 mm	65 mm	100 mm	300 mm	600 mm	2000 mm
Measurement range	20 to 45 mm	55 to 105 mm	75 to 130 mm	160 to 450 mm	200 to 1000 mm	1000 to 3500 mm
Light source	Red semiconductor laser; wavelength 655 nm (visible light)					
	Laser Class	Class 1 (FDA CDRH Part 1040.10 <sup>1</sup> , IEC 60825-1: 2014) Class 2 (FDA CDRH Part1040.10 <sup>1</sup> , IEC 60825-1: 2014)				
	Output	220 μW 560 μW				
Spot diameter (at the reference distance)	Approx. 200 x 750 μm	Approx. 550 x 1750 μm	Approx. 400 x 1350 μm	Approx. ø500 μm	Approx. ø1600 μm	Approx. 1400 x 7000 μm
Linearity <sup>*2 *3</sup>	±0.1% of F.S. (When used under 25 to 35 mm)	±0.1% of F.S. (When used under 55 to 75 mm)	±0.15% of F.S. (When used under 80 to 120 mm)	±0.25% of F.S. (When used under 160 to 440 mm)	±0.25% of F.S. (When used under 200 to 600 mm) ±0.5% of F.S. (When used under 200 to 1000 mm)	±0.16% of F.S. (When used under 1000 to 3500 mm)
Repeatability <sup>*4</sup>	1 μm	2 μm	4 μm	30 μm	50 μm	100 μm
Sampling rate	0.33/1/2/5 ms (Variable to 4 levels)					
Operating indicators	Laser emission warning indicator: green LED, Analog range indicator: orange LED, Reference distance indicator: red/green LED					
Temperature characteristic <sup>*3</sup>	0.05% of F.S./°C	0.06% of F.S./°C	0.06% of F.S./°C	0.08% of F.S./°C	0.08% of F.S./°C	0.016% of F.S./°C
Environmental resistance	Enclosure rating	IP67				
	Ambient light <sup>*5</sup>	Incandescent lamp: 5000 lx	Incandescent lamp: 7500 lx	Incandescent lamp: 5000 lx	Incandescent lamp: 10000 lx	
	Ambient temperature	-10 to + 50°C (No condensation and freezing)				
	Relative humidity	35 to 85% RH (No condensation)				
	Vibration	10 to 55 Hz, 1.5 mm double amplitude, 2 hours each for X, Y, and Z axes				
	Pollution degree	3				
Material	Housing material: PBT, Metal: SUS304, Packing: NBR, Lens cover: Glass, Cable: PVC					
Weight	Approx. 60 g	Approx. 75 g	Approx. 135 g	Approx. 350 g		

- \*1 The classification is implemented based on IEC60825-1 following the requirement of Laser Notice of FDA (CDRH).
- \*2 Value when measuring the KEYENCE standard target (white diffuse object).
- \*3 The F.S. of all of the models are as follows. IL-030: ±5 mm, IL-065: ±10 mm, IL-100: ±20 mm, IL-300: ±140 mm, IL-600: ±400 mm, IL-2000: +1000 to -1500 mm
- \*4 Is the value for when our standard object (white diffuse object) is measured at an average of 128 times and with a sampling rate of 1 ms from a standard distance. (IL-300/IL-600 is 2 ms and IL-2000 is 5 ms)
- \*5 Value when the sampling rate is set to 2 ms or 5 ms.

## Sensor Amplifier

Model		IL-1000	IL-1500	IL-1050	IL-1550
Amplifier type		DIN rail mount	Panel mount	DIN rail mount	Panel mount
Main unit/Expansion unit		Main unit		Expansion unit	
Head compatibility		Yes			
Display	Minimum display unit	IL-S025/IL-030: 1 μm, IL-S065/IL-065/IL-100: 2 μm, IL-300: 10 μm, IL-600: 50 μm, IL-2000: 100 μm			
	Display range	IL-S025/IL-030/IL-S065/IL-065/IL-100: ± 99.999 mm to ± 99 mm (Variable to 4 levels) IL-300/IL-600: ± 999.99 mm to ± 999 mm (Variable to 3 levels) IL-2000: ± 9999.9 to ± 9999 (Variable to 2 levels)			
	Display rate	Approx. 10 times/sec			
Analog voltage output <sup>*1</sup>		± 5 V, 1 to 5 V, 0 to 5 V Output impedance 100 Ω		No	
Analog current output <sup>*1</sup>		4 to 20 mA Maximum load resistance 350 Ω			
Control input <sup>*2</sup>	Bank switching input	No-voltage input			
	Zero shift input				
	Emission stop input				
	Timing input				
	Reset input				
Control output <sup>*3</sup>	Judgment output	Open collector (NPN/PNP switchable, N.O./N.C. switchable)			
	Alarm output	Open collector (NPN/PNP switchable, N.C. switchable)			
Power supply	Power voltage <sup>*4</sup>	10 to 30 VDC, including ripple (P-P) 10% Class2 or LPS <sup>*5</sup>		Supplied from main unit	
	Power consumption (without load)	2300 mW or less (at 30 V, 77 mA max.) <sup>*6</sup>	2500 mW or less (at 30 V, 84 mA max.) <sup>*7</sup>	2000 mW or less (at 30 V, 67 mA max.)	2200 mW or less (at 30 V, 74 mA max.)
Environmental resistance	Ambient temperature	-10 to +50°C (No freezing)			
	Relative humidity	35 to 85% RH (No condensation)			
	Vibration	10 to 55 Hz, 1.5 mm double amplitude, 2 hours each for X, Y, Z axes			
	Pollution degree	2			
Materials		Main unit case/Front panel: polycarbonate, keypad: polyacetal, cable: PVC			
Mass (including accessories)		Approx. 150 g	Approx. 170 g	Approx. 140 g	Approx. 160 g

<sup>\*1</sup> ± 5 V, 1 to 5 V, 0 to 5 V, or 4 - 20 mA should be selected.

<sup>\*2</sup> The four external input wires are assigned with desired inputs. Rated no-voltage input: ON voltage 2 V or less; OFF current 0.02 mA or less.

Rated voltage input is max. input rating 30 V or less, ON voltage 7.5 V or more, and OFF current 0.05 mA or less.

<sup>\*3</sup> Rated NPN open collector output: max. 50 mA/ch (20 mA/ch when expansion units are connected), 30 V or less, residual voltage 1 V or less. (1.5 V or less when five or more expansion units are connected.)

Rated PNP open collector output: max. 50 mA/ch (20 mA/ch when expansion units are connected), power voltage or less, residual voltage 2 V or less. (2.5 V or less when five or more expansion units are connected.)

<sup>\*4</sup> When connecting five or more expansion units, ensure that the power voltage is 20 to 30 V.

<sup>\*5</sup> Use Class 2 or LPS power supply with the overcurrent protection device rated 2.5 A or less.

<sup>\*6</sup> 18 W max. (Total power consumption when connecting seven expansion units and DL Series)

<sup>\*7</sup> 19.5 W max. (Total power consumption when connecting seven expansion units and DL Series)

# 5-2 Circuit Diagram

## Output Circuit Diagram

### When NPN output is selected

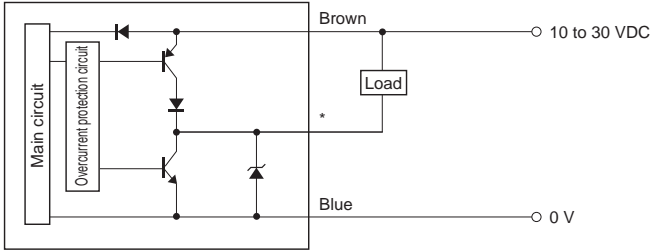

\* Black (HIGH judgment output)/White (LOW judgment output)/  
Gray (GO judgment output)/Green (alarm output)

### When PNP output is selected

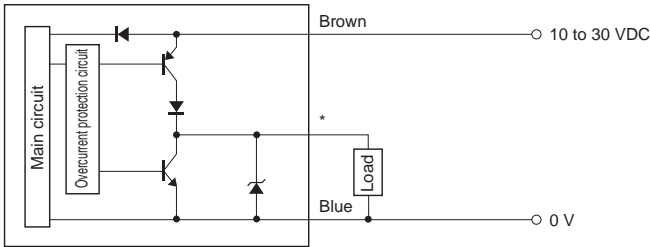

\* Black (HIGH judgment output)/White (LOW judgment output)/  
Gray (GO judgment output)/Green (edge check output)

## Analog Output Circuit

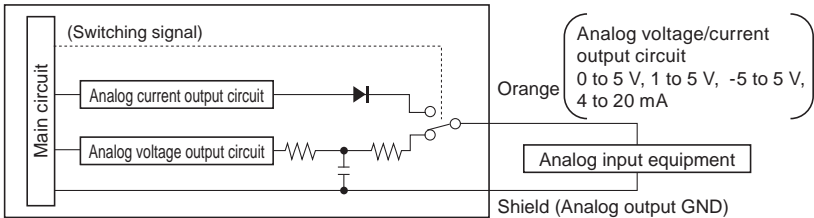

**Point**

**Do not short-circuit the shield (analog output GND) and blue (0 V).**

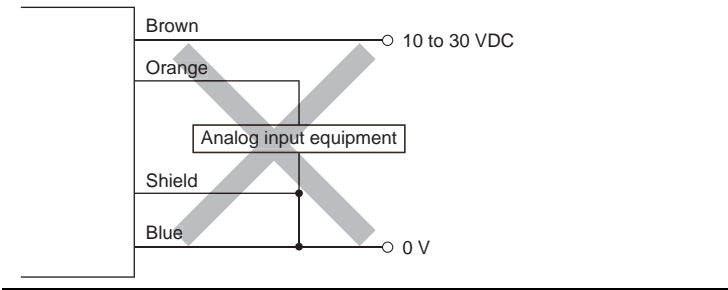

## Input Circuit Diagram

### When NPN output is selected

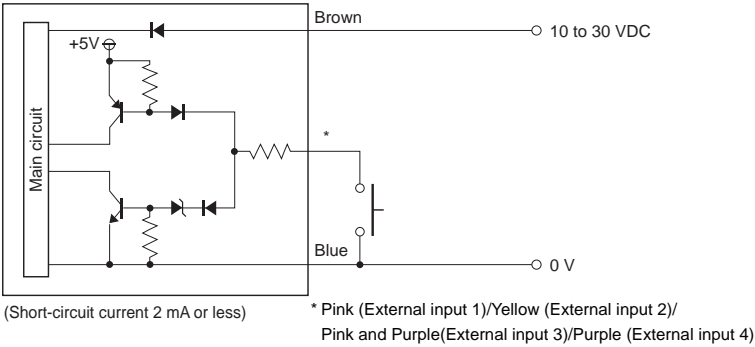

### When PNP output is selected

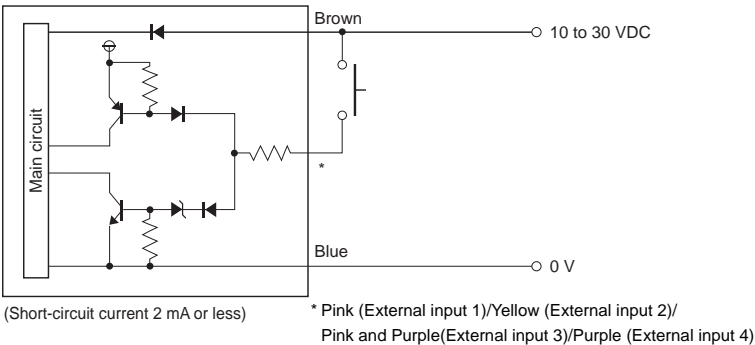

# 5-3 Dimensions

- Amplifier
- IL-1000/IL-1050

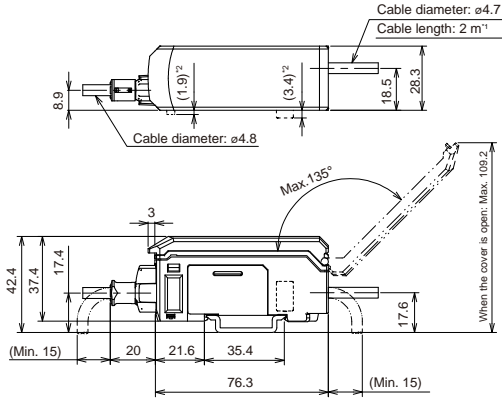

- \*1 Cable specification : IL-1000 12 cores, Nominal cross-section area brown/blue: 0.20 mm<sup>2</sup>, others 0.15 mm<sup>2</sup>  
: IL-1050 8 cores, Nominal cross-section area: 0.15 mm<sup>2</sup>
- \*2 Not mounted on the IL-1000.

- IL-1500/IL-1550

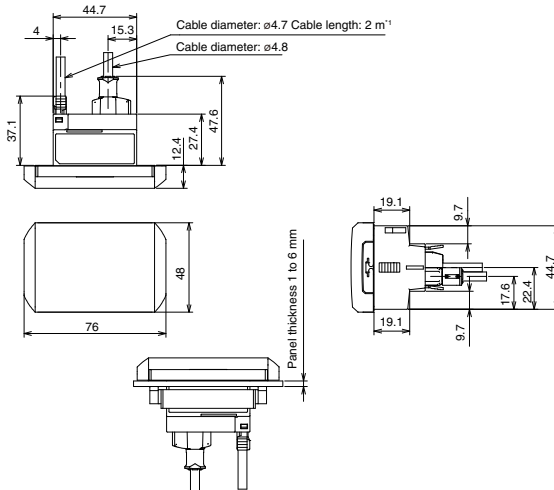

- \*1 Cable specification : IL-1000 12 cores, Nominal cross-section area brown/blue: 0.20 mm<sup>2</sup>, others 0.15 mm<sup>2</sup>  
: IL-1550 8 cores, Nominal cross-section area: 0.15 mm<sup>2</sup>

5 Specifications

### 5-3 Dimensions

- Sensor Head
- IL-S025/IL-030

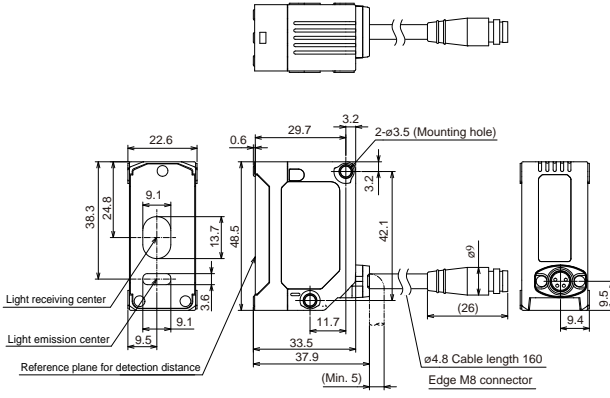

### Mounting bracket

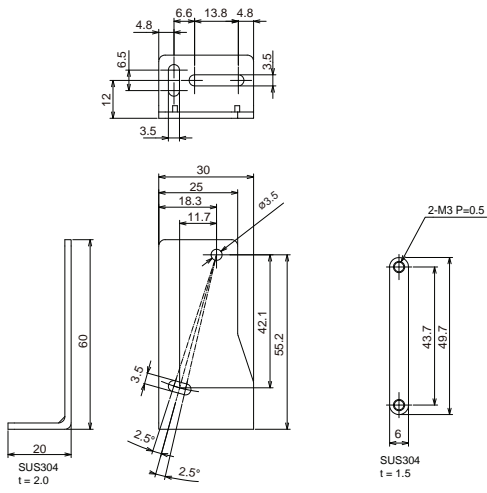

5 Specifications



● IL-S065/IL-065/IL-100

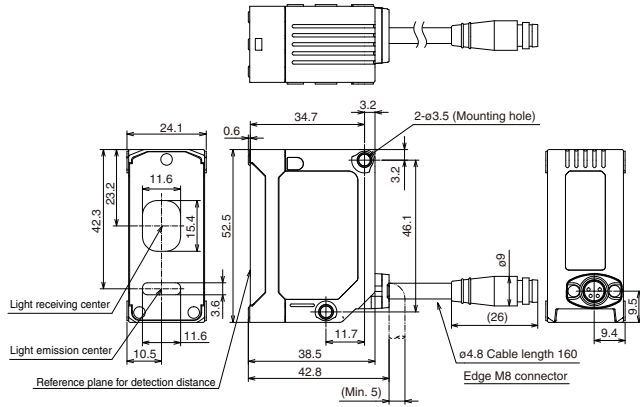

Mounting bracket

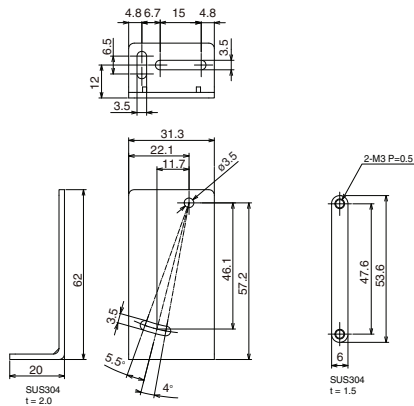

### 5-3 Dimensions

● IL-300/IL-600

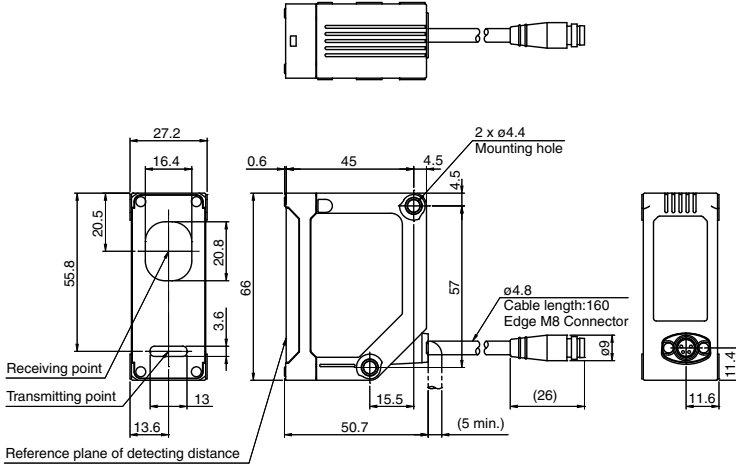

#### Mounting bracket

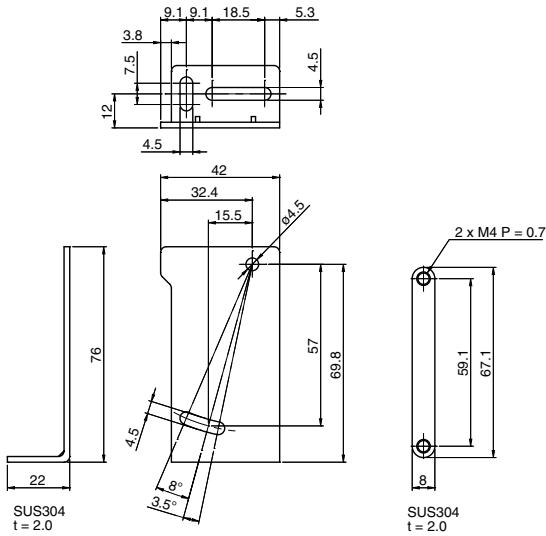

● IL-2000

When using the straight connector

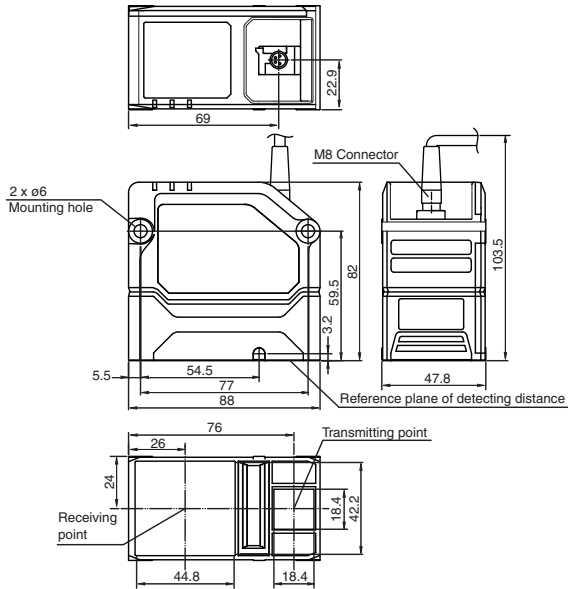

When using the L-shaped connector

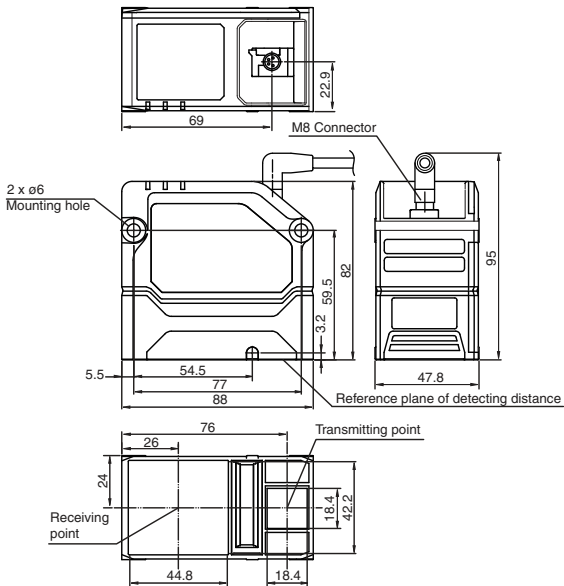



Mutual-interference

● IL-S025

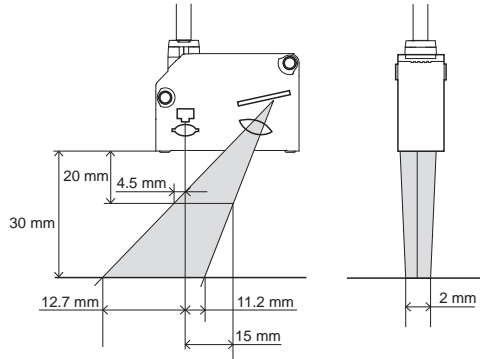

● IL-030

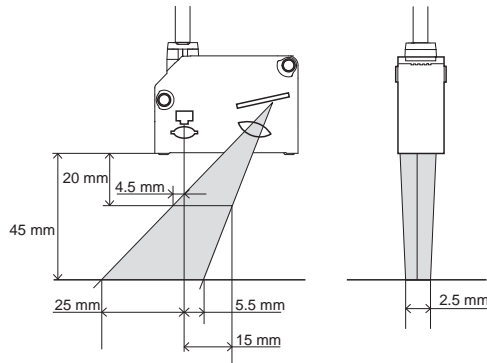

● IL-S065

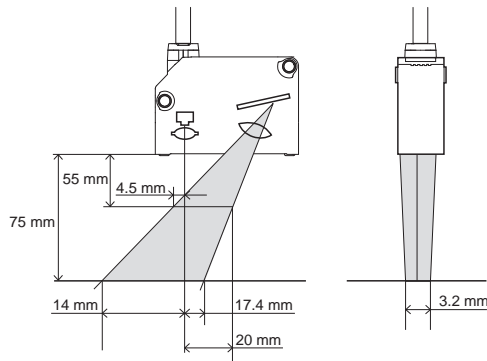

### 5-3 Dimensions

- IL-065/IL-100

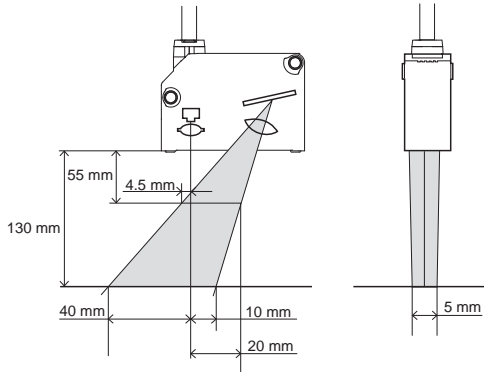

- IL-300

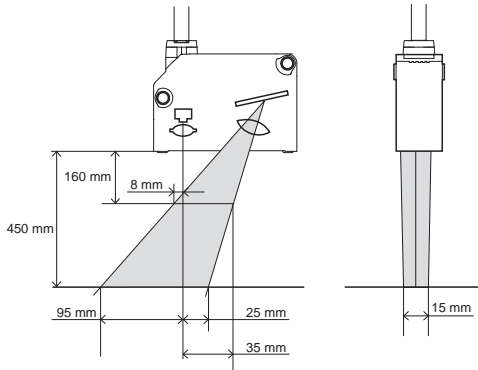

- IL-600

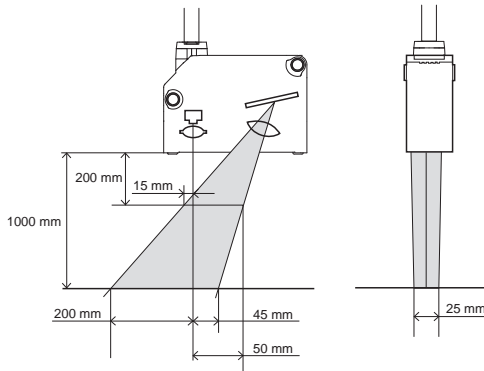

## ● IL-2000

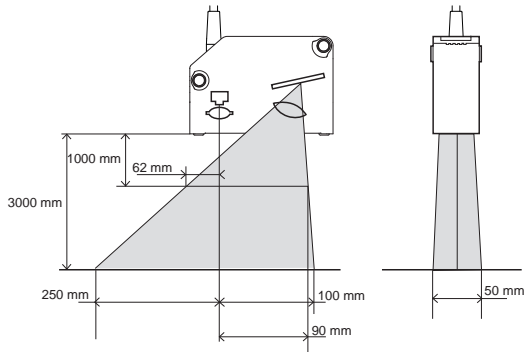

This drawing shows the interference area when the optical axis is perpendicular to the target surface.

The optical axis may vary by approximately  $\pm 1.5^\circ$  (IL-S025/IL-S065/IL-2000), or  $\pm 2.0^\circ$  (IL-030/IL-065/IL-100/IL-300/IL-600).

Spot Diameter

- IL-S025

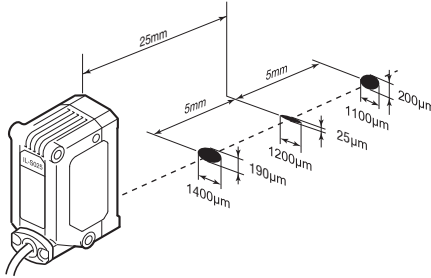

- IL-030

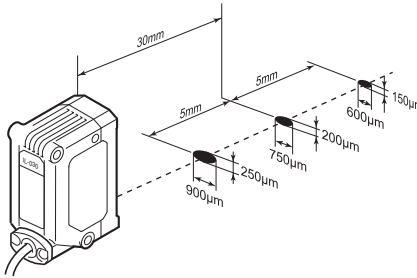

- IL-S065/IL-065

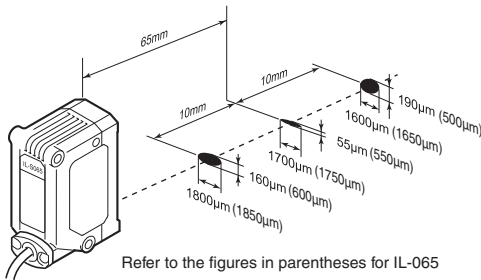

- IL-100

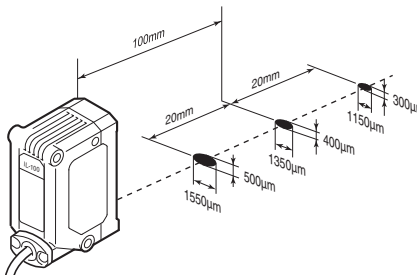



● IL-300

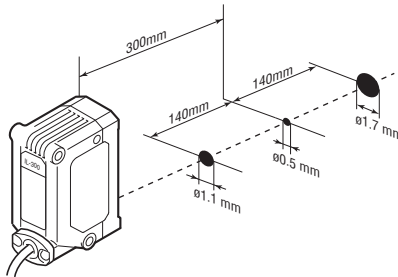

● IL-600

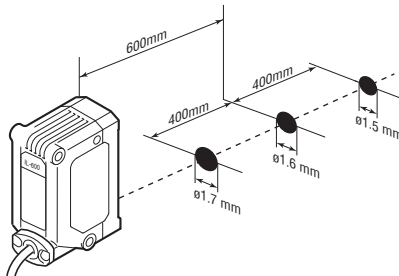

● IL-2000

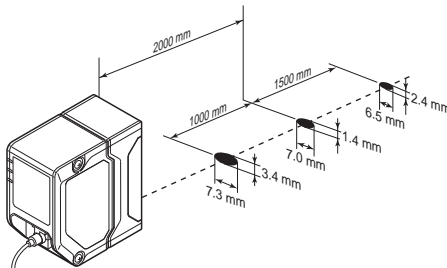

The optical axis may vary by approximately  $\pm 1.5^\circ$  (IL-S025/IL-S065/IL-2000), or  $\pm 2.0^\circ$  (IL-030/IL-065/IL-100/IL-300/IL-600).

# 5-4 Response Time

## ■ Response time

Response time means the following time range: from sensor recognition for the target object changes to output.

### Response time of judgment output (Maximum value)

[ms]

Sampling rate	Averaging						
	1	2	4	8	16	32	64
0.33 ms	4	4	5	6	9	14	25
1 ms	11	12	14	18	26	41	72
2 ms	21	23	27	35	50	81	143
5 ms	52	57	66	86	125	202	357

Sampling rate	Averaging					
	128	256	512	1024	2048	4096
0.33 ms	46	88	172	341	678	1351
1 ms	134	258	506	1002	1995	3979
2 ms	267	516	1012	2004	3988	7957
5 ms	667	1287	2528	5008	9970	19892

### Response time of analog output

Response time of judgment output +0.3 ms

## ■ Response time when the calculation function is used

When the calculation function is used, since the calculation process is added, the response time delays. Add the following times based on the response time which is calculated by the sampling rate and averaging, and the number of additional expansion units.

Number of additional units (including the main unit)	No DL Series connection	With DL Series connection
2 units	6 ms	11 ms
3 units	7 ms	14 ms
4 units	12 ms	18 ms
5 units	14 ms	20 ms
6 units	19 ms	24 ms
7 units	20 ms	27 ms
8 units	26 ms	31 ms

---

# Appendix

1	Troubleshooting.....	A-2
2	Display Screen and Output.....	A-8
3	Factory Setting (Default Value) List.....	A-9
4	Index.....	A-10

This section describes corrective actions when errors occur.

## Frequently Asked Questions

Problem	Check points	Corrective actions
Nothing is displayed on the amplifier control unit.	Is the power cable connected correctly?	Connect the power cable correctly. ☞ "Sensor Amplifier Wiring" (page 2-6)
	Is the sensor amplifier correctly added?	Add the sensor amplifier correctly. ☞ "Mounting the Sensor Amplifier" (page 2-2)
	The power saving function may be on.	Cancel the power saving function. ☞ "16. Power Saving Function" (page 4-40)
Values are not displayed.	Is the object within the detection range?	Adjust the object to correctly fall within the measurement range.
	Is there an obstacle within the measurement range?	Remove the obstacle.
	Is the hold function being used?	Check the hold function setting. Input the timing input according to the setting. ☞ "6. Hold Function" (page 4-15)
	The laser emission may be stopped.	Check whether the laser emission stop input is ON or not. ☞ "11. External Input" (page 4-30)
	Is there strong ambient light such as a photoelectric sensor and inverter fluorescent light?	Shield the ambient light to prevent it from entering the laser receiver.
	Is there mutual-interference?	<ul style="list-style-type: none"> <li>Shield the other transmitter laser light to prevent it from entering the laser receiver.</li> <li>Use the mutual-interference prevention function. ☞ "14. Interference Prevention Function (Only for IL-1000/1500)" (page 4-38)</li> </ul>
Are the output wire and input wire short-circuited?	Check the wiring. ☞ "Sensor Amplifier Wiring" (page 2-6)	
The value fluctuates.	Is the averaging set to small (response time set too fast)?	Increase the averaging. ☞ "3. Averaging rate, Step count filter, High-pass filter" (page 4-9)
	Is the object or sensor head vibrating?	Take adequate measures to prevent vibration.
	Is dirt or dust stuck to the laser transmitter/receiver?	Remove the dirt or dust. ☞ "Influence of dirt" (page 5)
	Is dust, dirt, water or oil stuck to the target?	Remove the dust, dirt, water, oil, etc. ☞ "Influence of dirt" (page 5)
	Are there airborne droplets of dust, water or oil during use?	Remove the droplets with air purge, etc.
	Is the mounting position deviated?	Correctly mount the sensor head. ☞ "Mounting the Sensor Head" (page 2-8)
Are the output wire and input wire short-circuited?	Check the wiring. ☞ "Sensor Amplifier Wiring" (page 2-6)	











Problem	Check points	Corrective actions
The values are incorrect.	Is the object tilted or located in an incorrect position?	Adjust the object to correctly fall within the measurement range.
	Is the mounting position deviated?	Correctly mount the sensor head. <input type="checkbox"/> "Mounting the Sensor Head" (page 2-8)
	Is dirt or dust stuck to the laser transmitter/receiver?	Remove the dirt or dust. <input type="checkbox"/> "Influence of dirt" (page 5)
	Is dust, dirt, water or oil stuck to the object?	Remove the dust, dirt, water, oil, etc. <input type="checkbox"/> "Influence of dirt" (page 5)
	Does the ambient operating temperature significantly change?	Keep the ambient operating temperature constant.
	Is the zero shift function correctly set?	Configure the settings correctly. <input type="checkbox"/> "Zero Shift Function (Shifting the Internal Measurement Value (R.V.))" (page 3-18)
	Is the shift target value set correctly?	
	Is the zero shift input wire connected correctly?	
	Is the calibration complete correctly?	Redo the calibration. <input type="checkbox"/> "Calibration Function" (page 4-45)
	Are the output wire and input wire short-circuited?	Check the wiring. <input type="checkbox"/> "Sensor Amplifier Wiring" (page 2-6)
Button operations are ignored.	Is the key lock function being used?	Cancel the key lock function. <input type="checkbox"/> "Key Lock Function" (page 3-21) The connected communication unit <DL-RS1A> read/write setting switch is set to RW. Set the read/write setting switch to R. <input type="checkbox"/> "RS-232C Communication Unit DL-RS1A User's Manual"
The judgment output cannot be output properly.	Is the output polarity set correctly?	Make the settings for NPN output and PNP output. <input type="checkbox"/> "Initial Reset (Initialize)" (page 3-8)
	Is the unit properly wired?	Wire the unit correctly. <input type="checkbox"/> "Output Circuit Diagram" (page 5-5)
	Is the tolerance setting value set correctly?	Set the tolerance setting value. <input type="checkbox"/> "Setting the Tolerance Setting Value" (page 3-10)
	Is the output state (N.O./N.C.) set correctly?	Set the output state. <input type="checkbox"/> "5. Output State" (page 4-14)
The analog output cannot be output properly.	Is the unit properly wired?	Wire the unit correctly. <input type="checkbox"/> "Output Circuit Diagram" (page 5-5)
	Is the type of analog output (current/voltage) set correctly?	Set the type of analog output. <input type="checkbox"/> "Initial Reset (Initialize)" (page 3-8)
The bank cannot be switched by the external input	Is the bank switching method set correctly?	Set the bank switching method. <input type="checkbox"/> "12. Bank Switching Method" (page 4-35)
The sensor head indicator does not change.	Is the power voltage used within the specification range?	Use the power voltage within the specification range. <input type="checkbox"/> "Specifications" (page 5-2)
	Is there an error message on the sensor amplifier?	Take adequate measures according to the error messages. <input type="checkbox"/> "Error Displays and Corrective Actions" (page A-4)



## Error Displays and Corrective Actions

When an error occurs, an error message appears on the sensor amplifier.

**Reference**

- If an error occurs, the judgment output changes to the error status and the alarm output turns OFF.
-  “5. Output State” (page 4-14)
- When [ErC] is displayed, all judgment outputs and alarm outputs turn OFF to protect the outputs.
- When the error display is other than [ErC] or [ErE], the analog voltage output is 5.5 V and the analog output current is 3.0 mA.

Error displays	Error contents	Corrective actions
 <p>Head error</p>	<ul style="list-style-type: none"> <li>• The sensor head is not connected.</li> <li>• The head cable is damaged.</li> <li>• The sensor head is damaged.</li> <li>• A sensor head is connected that is incompatible with this amplifier.</li> </ul>	<ul style="list-style-type: none"> <li>• Check the sensor head connection.</li> <li>• Check whether the head cable is damaged.</li> <li>• Check the connection of the head cable to the connector.</li> <li>• After checking the above matters, turn the power ON again.</li> <li>• Check the models of the sensor head and sensor amplifier.</li> </ul>
 <p>Transmitter laser error</p>	<p>Laser inside head is damaged.</p>	<p>Replace the head.</p>
 <p>Head model error</p>	<p>A head incompatible with this amplifier is connected.</p>	<p>Check the head and amplifier models.</p>
 <p>Overcurrent error</p>	<p>Overcurrent beyond specification is flowing through the judgment output and alarm output.</p>	<ul style="list-style-type: none"> <li>• Wire the unit correctly.</li> <li>•  “Output Circuit Diagram” (page 5-5)</li> <li>• Check the load and reduce the current to be within the specification range.</li> <li>• Check that the output wire is not touching other wires or the frame.</li> </ul>
 <p>EEPROM error</p>	<p>Reading/writing the nonvolatile memory (EEPROM) storage data failed.</p>	<p>Turn the power on again. Perform the initial reset.  “Initial Reset (Initialize)” (page 3-8)</p>
	<p>Data has been written in the nonvolatile memory (EEPROM) over 1 million times and malfunction occurred.</p>	<p>To save the setting values when the power is turned OFF, replace the sensor amplifier.</p>
	<p> <b>Reference</b></p> <p>When using the zero shift function frequently, make sure that the zero shift value is not saved in the nonvolatile memory (EEPROM).  “13. Zero Shift Value Memory Function” (page 4-38)</p>	
 <p>Communication error</p>	<p>Communication cannot be established between the added sensor amplifiers.</p>	<p>Make the setting for the added sensor amplifiers again after the power is turned OFF.  “Mounting the Sensor Amplifier” (page 2-2)</p>

Error displays	Error contents	Corrective actions
 <p>Additional setting error</p>	When using the calculation function, a model other than IL-1050 or IL-1550 is mounted next to the main unit, or there is no expansion unit.	<ul style="list-style-type: none"> <li>• Check the type of sensor amplifier after the power is turned OFF.</li> <li>• Turn the power OFF and then connect the expansion unit.</li> </ul>
 <p>Calculation error</p>	While using the calculation function, an error is found on the expansion unit (expansion unit 1) added next to the main unit.	Solve the error on the expansion unit 1.

## Non-Error Displays and Corrective Actions

When the judgment value (P.V.) is "-----" the judgment output becomes all OFF (When Normally Open is set), and the analog voltage output is 5.5 V and the analog output current is 3.0 mA.

☞ "5. Output State" (page 4-14)



☞ "10. Analog Output Scaling" (page 4-27)







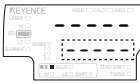

In cases other than the above, the judgment output and analog output keeps the output status immediately before the output.

### Reference



If the internal measurement value (R.V.) becomes [-----] because the target is out of the measurement range, the internal measurement value (R.V.) retains the value immediately before the target disappears for the period the response time elapses. After the response time elapses, the internal measurement value (R.V.) becomes [-----].

☞ "3. Averaging rate, Step count filter, High-pass filter" (page 4-9)

Display	Description	Corrective actions
 <p>The internal measurement value (R.V.) is displayed as [-----].</p>	<p>A target is not in the measurement range. A target cannot be measured.</p> <p>The laser emission stop input is ON.</p>	<p>Adjust the target to correctly fall within the measurement range.</p> <p>Set the laser emission stop input to OFF. Check the wiring of the laser emission stop input. ☞ "11. External Input" (page 4-30)</p>
 <p>The judgment value (P.V.) is displayed as [-----].</p>	The hold function is used and the judgment value (P.V.) is held.	<p>Check the hold function setting. Input the timing input according to the setting. ☞ "6. Hold Function" (page 4-15)</p>

Display	Description	Corrective actions
 <p>The internal measurement value (R.V.) is displayed as [-FFFF].</p>	The internal measurement value (R.V.) falls below the lower limit (-99.999) of display range.	<ul style="list-style-type: none"> <li>Check the setting for shift target value and shift the display again. <ul style="list-style-type: none"> <li>☐ "3-5 Zero Shift Function (Shifting the Internal Measurement Value (R.V.))" (page 3-18)</li> </ul> </li> <li>Redo the calibration. <ul style="list-style-type: none"> <li>☐ "Calibration Function" (page 4-45)</li> </ul> </li> </ul>
 <p>The internal measurement value (R.V.) is displayed as [FFFF].</p>	The internal measurement value (R.V.) goes beyond the upper limit (99.999) of display range.	
	The bank switching method is set to external input.	To switch the banks with button operations, set "12. Bank switching method" to [bLn].
	When the R.V. (Internal Measurement Value) is [-----], the tolerance tuning and the 2 point tuning will occur, and, when the P.V. (Judgment Value) is [-----] 1 point tuning will occur.	When the internal measurement value (R.V.) and judgment value (P.V.) is a number value, conduct tuning by the condition of the measured measurement object. <ul style="list-style-type: none"> <li>☐ "Setting the Tolerance Setting Value" (page 3-10)</li> </ul>
	<ul style="list-style-type: none"> <li>When the R.V. is [-----], the zero shift function was used.</li> <li>When the "3.AVE" is [HPF], the zero-shift was used.</li> </ul>	<ul style="list-style-type: none"> <li>Shift the display when the internal measurement value (R.V.) is displayed (with the object measured). <ul style="list-style-type: none"> <li>☐ "Zero Shift Function (Shifting the Internal Measurement Value (R.V.))" (page 3-18)</li> </ul> </li> <li>Make sure the "3.AVE" is not [HPF]. <ul style="list-style-type: none"> <li>☐ "3. Averaging rate, Step count filter, High-pass filter" (page 4-9)</li> </ul> </li> </ul>
	The SET1, SET2, or SET3 value is incorrect and the correction using the calibration function could not be performed.	Perform the calibration within the possible correction range. <ul style="list-style-type: none"> <li>☐ "Calibration Function" (page 4-45)</li> </ul>
	The button operation is disabled.	The connected communication unit <DL-RS1A> read/write setting switch is set to RW. Set the read/write setting switch to R. <ul style="list-style-type: none"> <li>☐ "RS-232C Communication Unit DL-RS1A User's Manual"</li> </ul>
	The light amount is saturated.	Tilt the sensor head so that regular reflectance beam is not received.







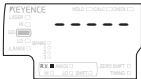

Display	Description	Corrective actions
	<p>The calculation mode was changed or the mutual-interference prevention function was changed with the main unit while the setting screen was displayed on the expansion unit.</p>	<p>Display the setting screen again. The previous settings are saved.</p>
	<ul style="list-style-type: none"> <li>• The main device delivered from December 22th, 2010, and the extension device delivered before December 21th, will have the calculation function setting included when the "3.AVE" is [HPF].</li> <li>• When "3.AVE" is [d,FF] The calculation setting is included.</li> </ul>	<ul style="list-style-type: none"> <li>• Please use the extension device shipped after December 22th, 2010.</li> <li>• Use a setting other than [d,FF] for "3.AVE".   "3. Averaging rate, Step count filter, High-pass filter" (page 4-9)</li> </ul>

Normally, the judgment value (P.V.) is displayed on the main display (upper level). This section describes the judgment output and analog output status when displays other than numbers appear on the main display.

## Reference

The judgment indicator on the sensor amplifier operates in the same way as Normally Open regardless of the output state setting.  
 "Setting the Tolerance Setting Value" (page 3-10)

Status	Amplifier		Control input			Control output		Analog output
	Upper level main display	Judgment indicator*1	Timing/Reset	Bank switching/emission stop	Zero-shift	Judgment output*1	Alarm	Voltage (current) value
Measuring	Judgment value (P.V)	Measurement results	Yes	Yes	Yes	Measurement results	Output: ON Display: OFF	Voltage (current) for measured value
Out of measurement range 	-----	All off	Yes	Yes	No	All OFF	Output: OFF Display: ON	Analog voltage output: 5.5 V fixed Analog current output: 3.0 mA fixed
Out of display range 	FFFF	Only HI lights	Yes	Yes	Yes	Only HIGH output ON	Output: ON Display: OFF	Fixed to upper limit of analog output range (For 1-5 V, fixed to 1 V) (When upper limit < lower limit: 1 V)
Out of display range 	-FFFF	Only LO lights	Yes	Yes	Yes	Only LOW output ON	Output: ON Display: OFF	Fixed to lower limit of analog output range (For 1-5 V, fixed to 1 V) (When upper limit < lower limit: 5 V)
Setting	Setting item	Follows setting details	During error: No Other than error: Yes	Yes	Outside measurement range, mid-error, mid-high-pass filter: No	Follows setting details	Output: ON Display: OFF	Follows setting details
Other than [E-r], [E-E] errors  "Error Displays and Corrective Actions" (page 4)	Error display	HI/LO simultaneously light	No	Yes	No	HIGH/LOW output simultaneously ON	Output: ON Display: OFF	Analog voltage output: 5.5 V fixed Analog current output: 3.0 mA fixed
Overcurrent error 	E-rC	All off	Yes	Yes	Yes	All OFF	Measurement in progress, or same as out of measurement range	Voltage (current) for measured value
EEPROM error 	E-rE	Measurement results	Yes	Yes	Yes	Measurement results	Measurement in progress, or same as out of measurement range	Voltage (current) for measured value

\*1 The output state of judgment output can be set to N.O. (Normally Open) or N.C. (Normally Close).

 "5. Output State" (page 4-14)

This section describes the factory settings (default values).

If the initial reset is performed, the default values will be restored as below except for the calibration function.

📖 “Initial Reset (Initialize)” (page 3-8)

### Values set on the main screen

The bank 0 to 3 have the same value.

Setting items	Default value
HIGH side setting value	5.000 (50 00)((500 0))
LOW side setting value	-5.000 (-50 00)((-500 0))
Shift target value	0.000 (0 00)((0 0))

### Basic Settings and Advanced Settings

Setting items	Default value	Description
1. Measurement direction	nor	The display value increments when the object approaches the sensor head.
2. Sampling rate	dEFLt	Default setting
3. Averaging rate, Step count filter, High-pass filter	16	Averaging:16
4. Alarm setting	dEFLt	Default setting
5. Output state	no	Normally Open
6. Hold function	S-H	Sample hold
7. Timing input	LEvEL	Level
8. Delay timer	oFF	The delay timer is not used.
9. Hysteresis	0.000 (0 00)((0 0))	0.000 mm (0.00 mm)((0.0 mm))
10. Analog output scaling	dEFLt	Default setting
11. External Input	dEFLt	Default setting
12. Bank switching method	btN	Button operation
13. Zero shift value memory function	n-oFF	Not save on the nonvolatile memory (EEPROM)
14. Interference prevention function	oFF	Mutual-interference prevention function OFF
15. Display digit	dEFLt	Default setting
16. Power saving function	oFF	Not display the power saving (Normally ON)
17. Head display mode	dEFLt	Normal
18. Display color	GoGrn	GO green

### Other functions

Setting items	Default value	Description
Calculation Function	oFF	The calculation function is not used.
Calibration Function	dEFLt	Default setting
Calculation calibration function	dEFLt	Default setting
Tolerance for tolerance tuning	0 200 (2 00)((20 0))	0.200 mm (2.00 mm)((20.0 mm))

The values for the IL300/600 are written in parentheses. The values for the IL-2000 are written in double parentheses.

**A**

Addition Mode .....	4-43
Analog Output Circuit .....	5-5
Analog Output Scaling .....	4-27
Attaching the sensor head cable connector (OP-84338:) .....	2-11
Auto bottom hold .....	4-22
Auto peak hold .....	4-21
Automatic Setting (When other than step count filter) .....	3-12
2 point tuning .....	3-14
Tolerance tuning .....	3-12
Automatic Setting (When step count filter) .....	3-16
1 point tuning .....	3-17
2 point tuning .....	3-16

**B**

Bank A input/Bank B input .....	4-34
Bank Function (Registering Multiple Tolerance Setting Values) .....	3-20
How to Switch the Bank .....	3-20
Settings Registered with the bank .....	3-20
Basic Settings and Advanced Settings .....	4-4
External Input .....	4-30
Bottom hold .....	4-18

**C**

Calculation Function .....	4-42
Calculation Value (CALC value) .....	4-42
Calibration Function .....	4-45
Checking the Package Contents .....	1-2
Circuit Diagram .....	5-5

**D**

Delay Timer .....	4-23
Dimensions .....	5-7
Display color .....	4-41
Display Digit .....	4-39
Display Screen and Output .....	A-8

**F**

Factory Setting (Default Value) List ....	A-9
---	-----

**H**

Hold Function .....	4-15
Hysteresis .....	4-26

**I**

Initial Reset (Initialize) .....	3-8
Input Circuit Diagram .....	5-6
Interference Prevention Function (only for IL-1000/1500) .....	4-38
Internal measurement value (R.V.) .....	3-3

**J**

Judgment output .....	3-10
Judgment value (P.V.) .....	3-3

**K**

Keylock Function .....	3-21
------------------------	------

**L**

Laser emission stop input .....	4-35
List of Setting Items .....	4-4

**M**

Main Display (Upper Level) .....	3-3
----------------------------------	-----

**N**

Normally open/Normally closed .....	4-14
-------------------------------------	------

**O**

Operation When the Power is Turned on for the First Time .....	3-2
Operations on the Main Screens .....	3-3
Output Circuit Diagram .....	5-5
Output mode .....	4-14

**P**

Peak hold .....	4-17
Peak-to-peak hold .....	4-19
Power Saving Function .....	4-40
Power/Input-output cable .....	2-7

**R**

R.V. (Internal Measurement Value) and P.V. (Judgment Value) .....	3-3
Reset input .....	4-31
Response Time .....	5-18

**S**

Sample hold .....	4-16
Saving zero shift value function .....	4-38
Setting Screen .....	4-6
Setting the Tolerance Setting Value ..	3-10
Specifications .....	5-2
Sub Display (Lower Level) .....	3-4
Subtraction Mode .....	4-43

**T**

Timing Input .....	4-23, 4-32
Troubleshooting .....	A-2

**Z**

Zero Shift Function (Shifting the Internal Measurement Value (R.V.)) .....	3-18
Setting the Shift Target Value .....	3-18
Zero shift input .....	4-31

## Revision History

Print date	Revision no.	Description
March, 2010	Initial release	
April, 2010	Second edition	IL-065 added
May, 2010	Revised first edition	Correspondence with CSA
June, 2010	Re-revised first edition	IL-300/IL-600 added
July, 2010	Re-revised second edition	Clerical error corrected
December, 2010	Revision 3, first edition	IL-S025/IL-S065 added, Step count filter function, High-pass filter function added
April, 2011	Revision 3, second edition	Clerical error corrected
August, 2012	5th revision 1st edition	IL-2000 added
September, 2012	5th revision 2nd edition	
August, 2015	5th revision 3rd edition	

# WARRANTIES AND DISCLAIMERS

- (1) KEYENCE warrants the Products to be free of defects in materials and workmanship for a period of one (1) year from the date of shipment. If any models or samples were shown to Buyer, such models or samples were used merely to illustrate the general type and quality of the Products and not to represent that the Products would necessarily conform to said models or samples. Any Products found to be defective must be shipped to KEYENCE with all shipping costs paid by Buyer or offered to KEYENCE for inspection and examination. Upon examination by KEYENCE, KEYENCE, at its sole option, will refund the purchase price of, or repair or replace at no charge any Products found to be defective. This warranty does not apply to any defects resulting from any action of Buyer, including but not limited to improper installation, improper interfacing, improper repair, unauthorized modification, misapplication and mishandling, such as exposure to excessive current, heat, coldness, moisture, vibration or outdoors air. Components which wear are not warranted.
- (2) KEYENCE is pleased to offer suggestions on the use of its various Products. They are only suggestions, and it is Buyer's responsibility to ascertain the fitness of the Products for Buyer's intended use. KEYENCE will not be responsible for any damages that may result from the use of the Products.
- (3) The Products and any samples ("Products/Samples") supplied to Buyer are not to be used internally in humans, for human transportation, as safety devices or fail-safe systems, unless their written specifications state otherwise. Should any Products/Samples be used in such a manner or misused in any way, KEYENCE assumes no responsibility, and additionally Buyer will indemnify KEYENCE and hold KEYENCE harmless from any liability or damage whatsoever arising out of any misuse of the Products/ Samples.
- (4) **OTHER THAN AS STATED HEREIN, THE PRODUCTS/SAMPLES ARE PROVIDED WITH NO OTHER WARRANTIES WHATSOEVER. ALL EXPRESS, IMPLIED, AND STATUTORY WARRANTIES, INCLUDING, WITHOUT LIMITATION, THE WARRANTIES OF MERCHANTABILITY, FITNESS FOR A PARTICULAR PURPOSE, AND NON-INFRINGEMENT OF PROPRIETARY RIGHTS, ARE EXPRESSLY DISCLAIMED. IN NO EVENT SHALL KEYENCE AND ITS AFFILIATED ENTITIES BE LIABLE TO ANY PERSON OR ENTITY FOR ANY DIRECT, INDIRECT, INCIDENTAL, PUNITIVE, SPECIAL OR CONSEQUENTIAL DAMAGES (INCLUDING, WITHOUT LIMITATION, ANY DAMAGES RESULTING FROM LOSS OF USE, BUSINESS INTERRUPTION, LOSS OF INFORMATION, LOSS OR INACCURACY OF DATA, LOSS OF PROFITS, LOSS OF SAVINGS, THE COST OF PROCUREMENT OF SUBSTITUTED GOODS, SERVICES OR TECHNOLOGIES, OR FOR ANY MATTER ARISING OUT OF OR IN CONNECTION WITH THE USE OR INABILITY TO USE THE PRODUCTS, EVEN IF KEYENCE OR ONE OF ITS AFFILIATED ENTITIES WAS ADVISED OF A POSSIBLE THIRD PARTY'S CLAIM FOR DAMAGES OR ANY OTHER CLAIM AGAINST BUYER.** In some jurisdictions, some of the foregoing warranty disclaimers or damage limitations may not apply.

## **BUYER'S TRANSFER OBLIGATIONS:**

If the Products/Samples purchased by Buyer are to be resold or delivered to a third party, Buyer must provide such third party with a copy of this document, all specifications, manuals, catalogs, leaflets and written information provided to Buyer pertaining to the Products/Samples.

Specifications are subject to change without notice.

## KEYENCE CORPORATION

[www.keyence.com/glb](http://www.keyence.com/glb)

1-3-14, Higashi-Nakajima, Higashi-Yodogawa-ku, Osaka, 533-8555, Japan PHONE: +81-6-6379-2211

### AUSTRIA

Phone: +43 (0)2236 378266 0

### BELGIUM

Phone: +32 (0)15 281 222

### BRAZIL

Phone: +55-11-3045-4011

### CANADA

Phone: +1-905-366-7655

### CHINA

Phone: +86-21-3357-1001

### CZECH REPUBLIC

Phone: +420 220 184 700

### FRANCE

Phone: +33 1 56 37 78 00

### GERMANY

Phone: +49-6102-3656-0

### HONG KONG

Phone: +852-3104-1010

### HUNGARY

Phone: +36 1 802 7360

### INDIA

Phone: +91-44-4963-0900

### INDONESIA

Phone: +62-21-2966-0120

### ITALY

Phone: +39-02-6688220

### KOREA

Phone: +82-31-789-4300

### MALAYSIA

Phone: +60-3-7883-2211

### MEXICO

Phone: +52-55-8850-0100

### NETHERLANDS

Phone: +31 (0)40 206 6100

### PHILIPPINES

Phone: +63-(0)2-8981-5000

### POLAND

Phone: +48 71 368 61 60

### ROMANIA

Phone: +40 (0)269 232 808

### SINGAPORE

Phone: +65-6392-1011

### SLOVAKIA

Phone: +421 (0)2 5939 6461

### SLOVENIA

Phone: +386 (0)1 4701 666

### SWITZERLAND

Phone: +41 (0)43 455 77 30

### TAIWAN

Phone: +886-2-2721-1080

### THAILAND

Phone: +66-2-078-1090

### UK & IRELAND

Phone: +44 (0)1908-696-900

### USA

Phone: +1-201-930-0100

### VIETNAM

Phone: +84-24-3772-5555

