



3-8450.090-1

Rev. G 11/05

English



## CAUTION!

- Remove power to unit before wiring input and output connections.
- Follow instructions carefully to avoid personal injury.

## Contents

1. Installation
2. Specifications
3. Electrical Connections
4. Menu Functions



## 1. Installation

ProcessPro transmitters are available in two styles: panel mount and field mount. The panel mount is supplied with the necessary hardware to install the transmitter. This manual includes complete panel mounting instructions.

Field mounting requires one of two separate mounting kits. The 3-8052 integral kit joins the sensor and instrument together into a single package. The 3-8050 Universal kit enables the transmitter to be installed virtually anywhere.

Detailed instructions for integral mounting or other field installation options are included with the 3-8052 Integral kit or the 3-8050 Universal kit.

### 1.1 Panel Installation

1. The panel mount transmitter is designed for installation using a 1/4 DIN Punch. For manual panel cutout, an adhesive template is provided as an installation guide. Recommended clearance on all sides between instruments is 1 inch.
2. Place gasket on instrument, and install in panel.
3. Slide mounting bracket over back of instrument until quick-clips snap into latches on side of instrument.
4. To remove, secure instrument temporarily with tape from front or grip from rear of instrument. **DO NOT RELEASE.** Press quick-clips outward and remove.

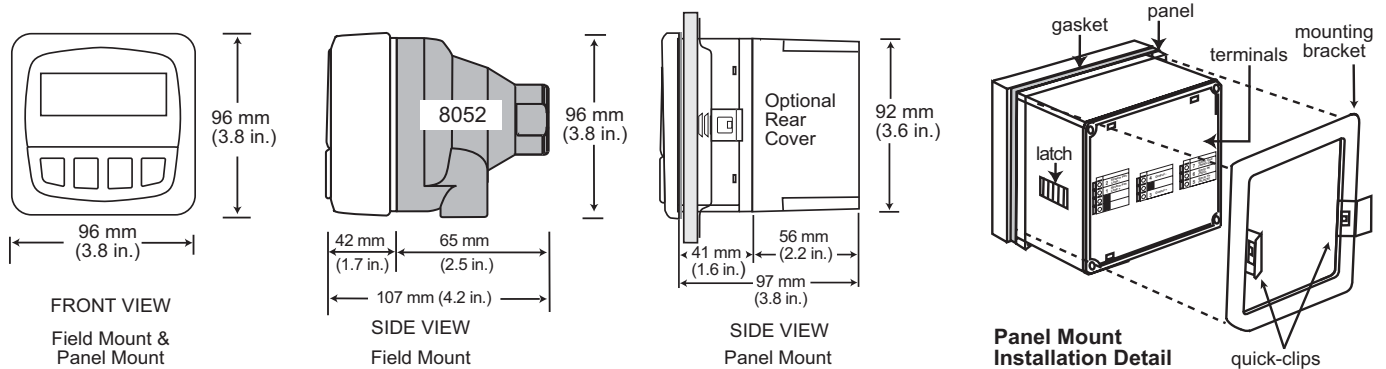

## 2. Specifications

### General

Compatibility: Signet 2450 Pressure Sensor

Accuracy:  $\pm 1\%$  of full scale

Repeatability:  $\pm 0.5\%$  of full scale

Enclosure:

- Rating: NEMA 4X/IP65 front
- Case: PBT
- Panel case gasket: Neoprene
- Window: Polyurethane coated polycarbonate
- Keypad: Sealed 4-key silicone rubber
- Weight: Approx. 325g (12 oz.)

Display:

- Alphanumeric 2 x 16 LCD
- Update rate: 1 second
- Contrast: User selected, 5 levels

### Electrical

Sensor Input:

- Range: 0-250 psig, 0-17 bar, 0-1700 kPa

Current output:

- 4 to 20 mA, isolated, fully adjustable and reversible
- Power: 12 to 24 VDC  $\pm 10\%$ , regulated, 21 mA max current

- Max loop impedance: 50  $\Omega$  max. @ 12 V, 325  $\Omega$  max. @ 18 V, 600  $\Omega$  max. @ 24 V

- Update rate: 100 ms

- Accuracy:  $\pm 0.03$  mA

Open-collector output: Hi, Lo, Programmable:

- Open-collector, optically isolated, 50 mA max. sink, 30 VDC max. pull-up voltage
- Hysteresis: User adjustable

### Environmental

- Operating temperature: -10 to 70°C (14 to 158°F)
- Storage temperature: -15 to 80°C (5 to 176°F)
- Relative humidity: 0 to 95%, non-condensing
- Maximum altitude: 2000 m (6562 ft)
- Insulation category: II
- Pollution degree: 2

### Standards and Approvals

- CSA, CE, UL listed
- Immunity: EN50082-2
- Emissions: EN55011 Class B
- Manufactured under ISO 9001 and ISO 14001

### 3. Electrical Connections



**Caution:** Failure to fully open terminal jaws before removing wire may permanently damage instrument.

#### Wiring Procedure

1. Remove 0.5 - 0.625 in. (13-16 mm) of insulation from wire end.
2. Press the orange terminal lever downward with a small screwdriver to open terminal jaws.
3. Insert exposed (non-insulated) wire end in terminal hole until it bottoms out.
4. Release orange terminal lever to secure wire in place. Gently pull on each wire to ensure a good connection.

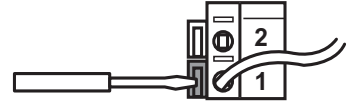

#### Wiring Removal Procedure

1. Press the orange terminal lever downward with a small screwdriver to open terminal jaws.
2. When fully open, remove wire from terminal.

#### Wiring Tips:

- Do not route sensor cable in conduit containing AC power wiring. Electrical noise may interfere with sensor signal.
- Routing sensor cable in grounded metal conduit will help prevent electrical noise and mechanical damage.
- Seal cable entry points to prevent moisture damage.
- Only one wire should be inserted into a terminal. Splice double wires outside the terminal.
- The cable length from the sensor to the transmitter must not exceed 400 ft. (122 m)
- For best performance, ground the sensor SHIELD wire to a local earth ground at a point near the sensor.  
(Experiment with connecting the sensor shield wire to different local ground points to identify best signal quality.)

**Terminals 1 and 2: Loop Power**  
 12-24 VDC  $\pm 10\%$  system power and current loop output.  
 Max. loop impedance:  
 50 $\Omega$  max. @ 12 V  
 325 $\Omega$  max. @ 18 V  
 600 $\Omega$  max. @ 24 V

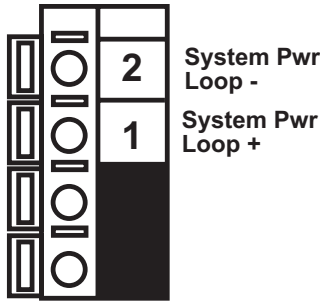

**Terminals 5-7: Digital sensor input**  
 See next page for more information.

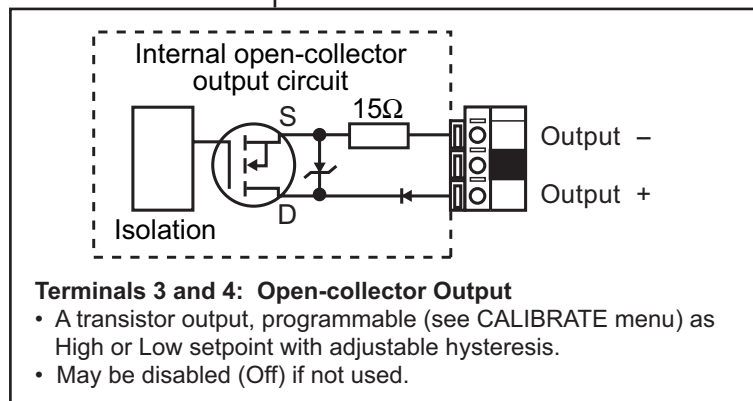
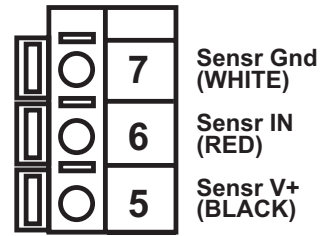
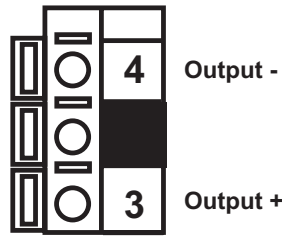

### 3.1 Sensor Input Connections



### 3.2 System Power/Loop Connections

Stand-alone application, no current loop used

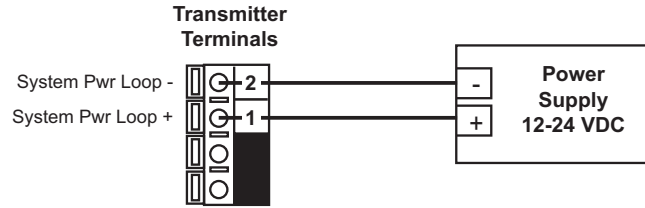

Connection to a PLC/Recorder, separate supply

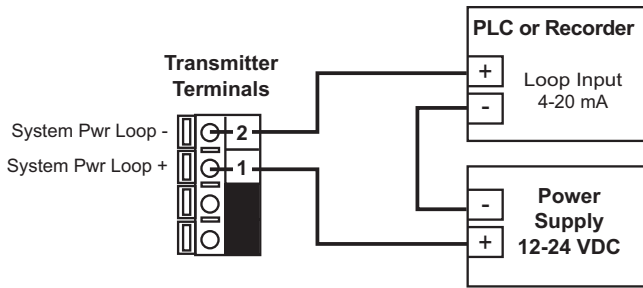

Connection to a PLC with built-in power supply

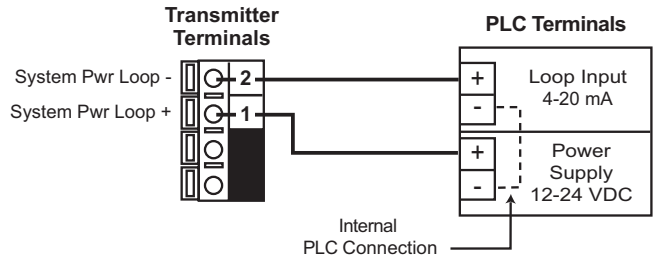

Example: Two transmitters connected to PLC/Recorder with separate power supply

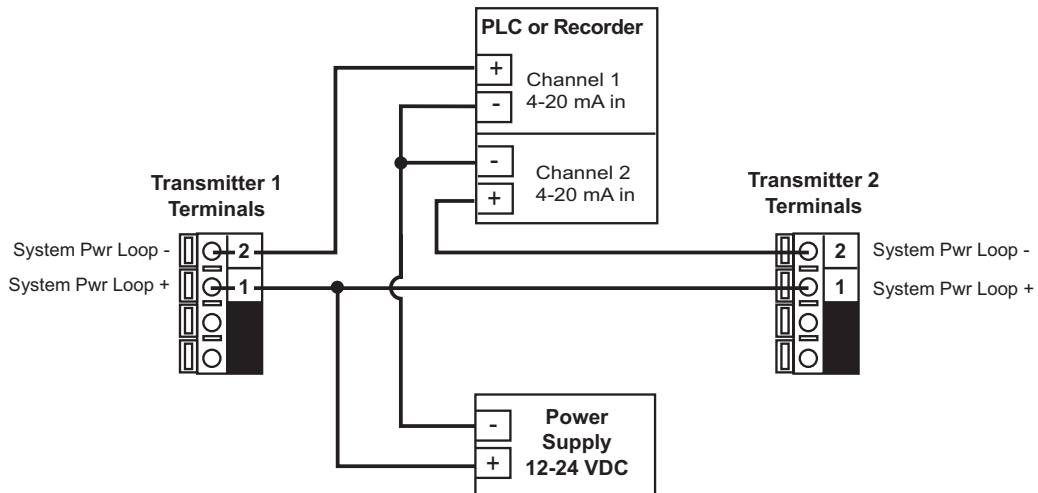

### 3.3 Open Collector Output

The Open Collector output can be used as a switch that responds when the process value moves above or below a setpoint, or it can be used to generate a pulsing signal with a rate proportional to the process value.

- **Low:**

Output triggers when process variable is less than the setpoint. The output will relax when the process variable moves above the setpoint plus the hysteresis value.



- **High:**

Output triggers when process variable is greater than the setpoint. The output will relax when the process variable moves below the setpoint plus the hysteresis value.

- **Off**

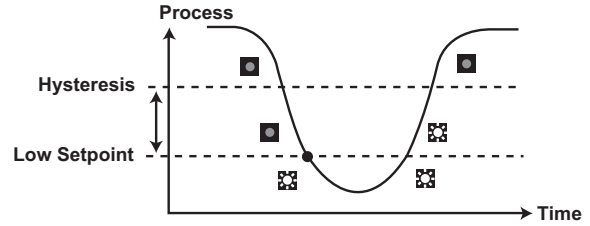
The outputs may be disabled if not being used.



**Output energized**   
**Output relaxed** 

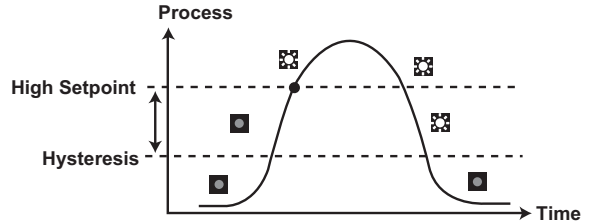

## VIEW menu

- During normal operation, the ProcessPro displays the VIEW menu.
- When using the CALIBRATE or OPTIONS menus, the ProcessPro will return to the VIEW menu if no activity occurs for 10 minutes.
- To select the item you want displayed, press the UP or DOWN arrow keys. The items will scroll in a continuous loop.
- Changing the display selection does not interrupt system operations.
- No keycode is necessary to change display selection.
- Output settings cannot be edited from the VIEW menu.



### View Menu

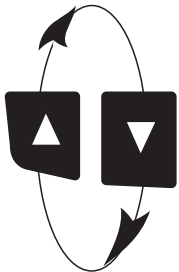

Display	Description
<b>Pressure:</b> 60 psi	Monitor the pressure input from the sensor. This is the permanent display.

The displays below are temporary. The permanent display will return after 10 minutes

<b>Loop Output:</b> 12.00 mA	Monitor the 4-20 mA Loop output.
<b>Last Cal</b> 06-30-03	Monitor date for scheduled maintenance or date of last calibration.

# ProcessPro Editing Procedure:

## Step 1. Press and hold ENTER key:

- 2 seconds to select the CALIBRATE menu
- 5 seconds to select the OPTIONS menu.

## Step 2. The Key Code is UP-UP-UP-DOWN keys in sequence.

- After entering the Key Code, the display will show the first item in the selected menu.

## Step 3. Scroll menu with UP or DOWN arrow keys.

## Step 4. Press RIGHT ARROW key to select menu item to be edited.

- The first display element will begin flashing.

## Step 5. Press UP or DOWN keys to edit the flashing element.

- RIGHT ARROW key advances the flashing element.

## Step 6. Press ENTER key to save the new setting and return to Step 3.

### Notes on Step 1:

- The View Menu is normally displayed.
- The CALIBRATE and OPTIONS menus require a KEY CODE.

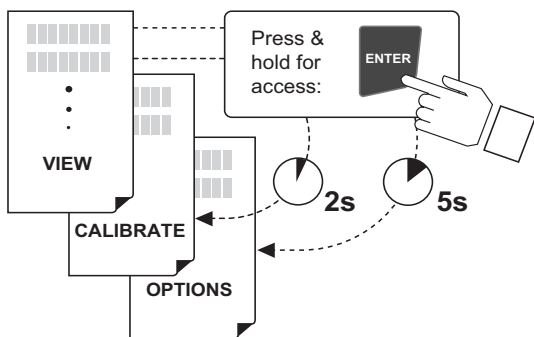

### Notes on Step 2:

If no key is pressed for 5 minutes while display is showing "Enter Key Code", the display will return to the VIEW menu.

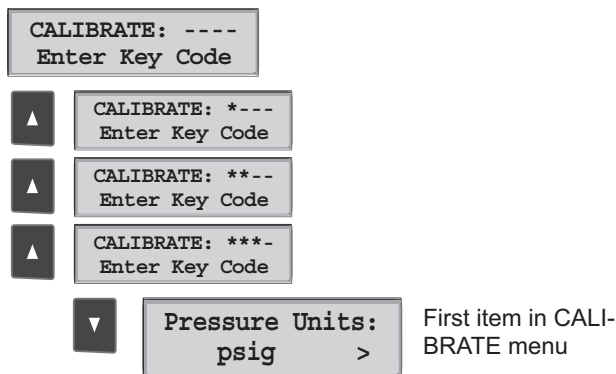

### Notes on Steps 3 and 4:

- Refer to pages 6 and 7 for complete listing of menu items and their use.
- From the Step 3 display, pressing the UP and DOWN keys simultaneously will return the display to the VIEW menu.
- If no key is pressed for 10 minutes, display will also return to the VIEW menu.

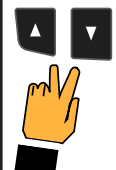

**Step 3: Finished Editing?**  
Press the UP and DOWN keys simultaneously after saving the last setting to return to normal operation.

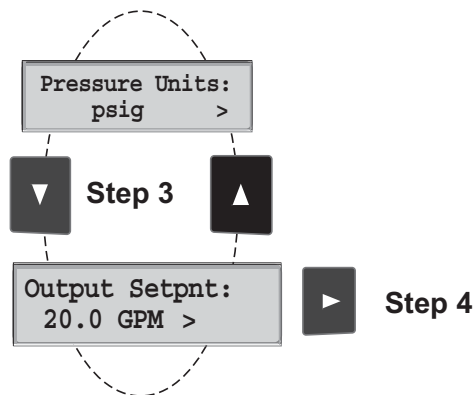

### Notes on Steps 5 and 6:

- All output functions remain active during editing.
- Only the flashing element can be edited.
- RIGHT ARROW key advances the flashing element in a continuous loop.
- Edited value is effective immediately after pressing ENTER key.
- If no key is pressed for 10 minutes unit will restore the last saved value and return to step 3.
- Step 6 (pressing ENTER key) always returns you to Step 3.
- Repeat steps 3-6 until all editing is completed.

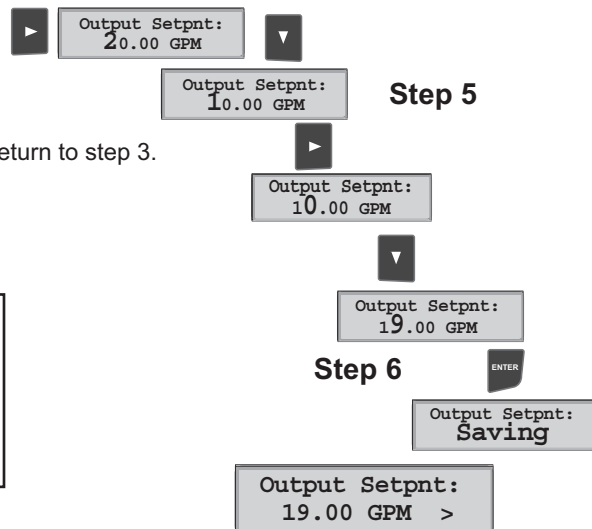

**Step 5: Made an Error?**

Press the UP and DOWN keys simultaneously while any element is flashing. This will recall the last saved value of the item being edited and return you to Step 3.



## Calibrate Menu

Display (Factory settings shown)	Description
<b>Pressure Units:</b> psi >	Select Pressure units for both input channels: psi, bar or kPa.
<b>Set:</b> Pressure >	Provides a maximum 5 psi offset to match 8450 to external reference. Enter "-999" to restore the original Factory calibration value. Changes to this setting will become effective when the display exits the Calibrate menu.
<b>Loop 1 Range: psi</b> 0.0 – 100.0 >	Check the 2450 Sensor instructions for the range capability of your sensor. Be sure to modify this setting if you change the Pressure Units.
<b>Output1 Mode</b> Low >	Select the mode of operation for the Open Collector output: OFF, LOW or HIGH.
<b>Output1 Setpnt:</b> 10.0 psi >	The Open Collector Output will be activated when the pressure reaches this value. Be sure to modify this setting if you change the Pressure Units.
<b>Output1 Hys:</b> 5 >	The Open Collector Output will be deactivated at <u>setpoint ± Hysteresis</u> (depending on High or Low selection).
<b>Last Cal</b> 06-30-03 >	Use this "note pad" to record important dates, such as annual recertification or scheduled maintenance.

## Options Menu

Display (Factory settings shown)	Description
<b>Contrast:</b> 3 >	Adjust the LCD contrast for best viewing. A setting of 1 is lower contrast, 5 is higher. In general, select lower contrast if the display is in warmer ambient surroundings.
<b>Decimal</b> ***.* >	Set the decimal to the best resolution for your application. The display will automatically scale down to this restriction. Select ***, **, **. or *.
<b>Averaging</b> Off >	OFF provides the most instantaneous response to changes in pressure. It is the preferred option in systems where the measurement is very stable. Select LOW or HIGH averaging if your process experiences frequent or extreme fluctuations in pressure.
<b>Output Active:</b> Low >	Active HIGH: This setting is used to turn a device (pump, valve) ON at the setpoint. Active LOW: This setting is used to turn a device OFF at the setpoint.
<b>Loop Adjust:</b> 4.00 mA >	Adjust the minimum and maximum current output. The display value represents the precise current output. Adjustment limits: <ul style="list-style-type: none"> <li>• 3.80 mA &lt; 4.00 mA &gt; 5.00 mA</li> <li>• 19.00 mA &lt; 20.00 mA &gt; 21.00 mA</li> </ul> Use this setting to match the system output to any external device.
<b>Loop Adjust:</b> 20.00 mA >	
<b>Test Loop:</b> >	Press UP and DOWN keys to manually order any output current value from 3.6 mA to 21.00 mA to test the output loop.
<b>Test Output:</b> >	Press UP and DOWN keys to manually toggle the relay state.

## Troubleshooting

Display Condition	Possible Causes	Suggested Solutions
"Check Sensor?"	<ul style="list-style-type: none"> <li>• Sensor not wired properly.</li> <li>• Sensor connected to 8450 while power is on.</li> <li>• Defective sensor.</li> </ul>	<ul style="list-style-type: none"> <li>• Correct sensor wiring.</li> <li>• Recycle power with all sensors connected.</li> <li>• Replace defective sensor.</li> </ul>
"Too much error CHECK SENSOR"	The value entered in Set Pressure field is greater than 5 psi deviation from sensor input. (The 8450 allows a maximum of 5 psi calibration offset.)	<ul style="list-style-type: none"> <li>• Confirm calibration values.</li> <li>• Remove sensor from installation, check 8450 reading (should be zero). If necessary, Set Pressure to zero, reinstall sensor, then recalibrate.</li> </ul>
"Reset to Factory Calibration"	Value in SET PRESSURE field is -999.	Entering "-999" in this field will remove all user calibration input and restore the factory values.
Open Collector output is activated when process is within the setpoint	Hysteresis value too large.	Reset hysteresis value in Calibrate menu.
"SETUP READ ERROR Press Any Key"	Memory fault occurred.	<ul style="list-style-type: none"> <li>• Press any key to reload factory presets.</li> <li>• Reprogram all setpoints.</li> <li>• If this message appears again, replace the 8450.</li> </ul>

## Ordering Information

Mfr. Part No.	Code	Description
3-8450-1	159 000 041	Pressure transmitter, Field mount
3-8450-1P	159 000 042	Pressure transmitter, Panel mount
3-8450-2	159 000 043	Pressure transmitter, Field mount with relays
3-8450-2P	159 000 044	Pressure transmitter, Panel mount with relays
3-8450-3	159 000 045	Pressure transmitter, Field mount with dual input/output
3-8450-3P	159 000 046	Pressure transmitter, Panel mount with dual input/output

## Accessories

Mfr. Part No.	Code	Description
3-8050	159 000 184	Universal mounting kit
3-8052	159 000 188	3/4 in. Integral mounting kit
3-8052-1	159 000 755	3/4 in. NPT mount junction box
3-8050.395	159 000 186	Splashproof rear cover
3-8050.396	159 000 617	RC Filter kit (for relay use)
3-0000.596	159 000 641	Heavy duty wall mount bracket
3-5000.598	198 840 225	Surface Mount Bracket
3-9000.392	159 000 368	Liquid tight connector kit for rear cover (includes 3 connectors)
3-9000.392-1	159 000 839	Liquid tight connector kit, NPT (1 piece)
3-9000.392-2	159 000 841	Liquid tight connector kit, PG13.5 (1 piece)



George Fischer Signet, Inc. 3401 Aerojet Avenue, El Monte, CA 91731-2882 U.S.A. • Tel. (626) 571-2770 • Fax (626) 573-2057  
 For Worldwide Sales and Service, visit our website: [www.gfsignet.com](http://www.gfsignet.com) • Or call (in the U.S.): (800) 854-4090

