

**Signet 2724-2726 and 2734-2736 Series DryLoc pH and ORP Electrodes**

3-2724.090 Rev. 20 10/19

*Operating Instructions*

**2724 & 2725  
2734 & 2735  
Flat Style  
Electrode**



**2726 & 2736  
Protected  
Bulb Style  
Electrode**



- [English](#)
- [Deutsch](#)
- [Français](#)
- [Español](#)
- [Italiano](#)
- [Português](#)
- [中文](#)
- [한국어](#)

**Description**

Signet General Purpose 2724-2726 and High Performance 2734-2736 series of pH and ORP electrodes are designed to minimize maintenance time and maximize performance longevity and value.

- The unique DryLoc® connector provides quick assembly and a secure connection featuring gold-plated contacts and an O-ring seal.
- The patented design features a lengthened reference chamber pathway to extend the operational life of the electrode.
- Wetted materials are selected to withstand a wide range of industrial applications.
- Multiple mounting features address the need for installation flexibility. These electrodes can be threaded into ¼ in. NPT or ISO 7/1 R¾ inch pipe fittings, submerged in a tank, or mounted into familiar Signet installation fittings ranging from 0.5" to 4" size.
- Combine the 2724-2726 or 2734-2736 electrodes with the Signet 2751 Smart Sensor Electronics or the 2760 Preamplifier to provide a 4 to 20 mA loop to a Programmable Logic Controller (PLC), SCADA system, or datalogger.
- Memory chip enabled to store Manufacturing, Calibration and Operational Data.
  - Manufacturing Information (Serial Number, Model Number, and Factory Glass Impedance).
  - Calibration Information (Factory Calibration pH/ORP, Factory Calibration Temperature, User Calibration pH/ ORP, User Calibration Temperature, Offset pH/ORP and Slope Efficiency % pH/ORP).
  - Operational Data (Sensor Runtime Hours, Minimum & Maximum Measured pH/ ORP, and Minimum and Maximum Measured Temperature).
- For more flexibility and unique features, pair the 2724-2726 or 2734-2736 series with a 2751 Smart Sensor Electronics and the 9900 Transmitter, 9950 Dual Channel Transmitter or the 0486 Profibus Concentrator. Additional features include electrode health monitoring and diagnostics through glass impedance measurement, broken glass detection and reference impedance measurement. Convenient remote calibration eliminates the hassle of field calibration.
- Connect up to six 2724-2726 or 2734-2736 electrodes to one 8900 Multi-Parameter Controller with six 2751 pH/ORP Sensor Electronics using digital (S<sup>3</sup>L) serial data output.
- Connect up to two 2724-2726 or 2734-2736 electrodes to one 9950 Dual Channel Transmitter with two 2751 pH/ORP Sensor Electronics using digital (S<sup>3</sup>L) output for a truly amazing set of features, options and measurements.
- The 2724-2726 electrodes are recommended for general purpose applications.
- The High Performance 2734-2736 electrodes are recommended for harsh applications.
- The 2734-2736 electrodes utilize advanced reference technology and special formulation glass to extend electrode life in all applications.

## Warranty Information

Refer to your local Georg Fischer Sales office for the most current warranty statement.

All warranty and non-warranty repairs being returned must include a fully completed Service Form and goods must be returned to your local GF Sales office or distributor. Product returned without a Service Form may not be warranty replaced or repaired.

Signet products with limited shelf-life (e.g. pH, ORP, chlorine electrodes, calibration solutions; e.g. pH buffers, turbidity standards or other solutions) are warranted out of box but not warranted against any damage, due to process or application failures (e.g. high temperature, chemical poisoning, dry-out) or mishandling (e.g. broken glass, damaged membrane, freezing and/or extreme temperatures).

## Product Registration

Thank you for purchasing the Signet line of Georg Fischer measurement products.

If you would like to register your product(s), you can now register online in one of the following ways:







- Visit our website [www.gfsignet.com](http://www.gfsignet.com) and click on **Product Registration Form**.
- If this is a pdf manual (digital copy), [click here](#).

## Safety Information

1. Use appropriate eye, face, hand, body and/or respiratory protection when using chemicals or solvents.
2. Prior to installation or removal:
  - Depressurize and vent system
  - Drain below sensor level.
3. Confirm chemical compatibility before use.
4. Do not exceed the max. temperature/pressure specifications.
5. Do not alter product construction.

### If installing into a threaded connection:

6. Inspect threads to ensure integrity. Do not install a sensor that has damaged threads.
7. Apply PTFE tape to the 3/4" M-NPT or ISO 7/1-R 3/4 process connection threads in accordance with industry practices.
8. **HAND TIGHTEN** the sensor into the process connection. **DO NOT USE TOOLS.**

	<b>Caution / Warning / Danger</b> Indicates a potential hazard. Failure to follow all warnings may lead to equipment damage, injury, or death
	<b>Personal Protective Equipment (PPE)</b> Always utilize the most appropriate PPE during installation and service of Signet products.
	<b>Pressurized System Warning</b> Sensor may be under pressure, take caution to vent system prior to installation or removal. Failure to do so may result in equipment damage and/or serious injury.
	<b>Hand Tighten Only</b> Overtightening may permanently damage product threads and lead to failure of the retaining nut.
	<b>Do Not Use Tools</b> Use of tool(s) may damage product beyond repair and potentially void product warranty.
	<b>Note / Technical Notes</b> Highlights additional information or detailed procedure.
	<b>Do Not Freeze</b> Products are temperature sensitive and may contain freezable liquids. Freezing damage to pH, ORP, and Chlorine electrodes voids product warranty.

## Chemical Compatibility

The retaining nuts of pH and ORP sensors are not designed for prolonged contact with aggressive substances. Strong acids, caustic substances and solvents or their vapor may lead to failure of the retaining nut, ejection of the sensor and loss of the process fluid with possibly serious consequences, such as damage to equipment and serious personal injury. Retaining nuts that may have been in contact with such substances, e.g. due to leakage or spilling, must be replaced.

- The use of this product assumes operators are trained and familiar with this type of device.
- Operators should be knowledgeable of the potential risks associated with pressurized piping systems.
- Operators **MUST** follow all necessary safety procedures.

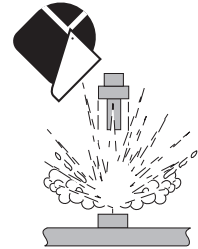

## Dimensions

### 2724, 2725, 2734, & 2735 Flat Glass Electrode

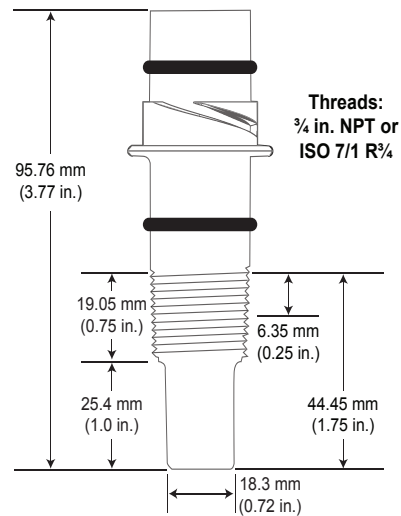

### 2726 & 2736 Protected Bulb Glass Electrode

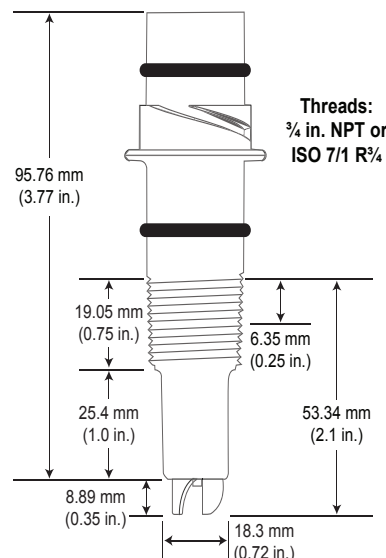

## Specifications

### General

Compatibility..... 2751 pH/ORP Smart Sensor Electronics,  
2760 pH/ORP Preamplifier  
(2724-2726 3K Balco only)

### pH Temp. Sensor:

Pt1000..... Compatible with 2751 pH/ORP Smart  
Sensor Electronics

Connection to..... PLC, 9900 Transmitter,  
8900 Multi-Parameter Controller  
9950 Dual Channel Transmitter

3 KΩ Balco..... Compatible with 2760 Preamplifier

Connection to..... 8750 pH/ORP Transmitter

Process Connection..... ¾ in. NPT, ISO 7/1 R¾ threads,  
or Signet Installation Fittings 0.5" to 4" sizes

### Wetted Materials

pH (2724 & 2726)..... Ryton (PPS), glass, UHMW PE, FKM

ORP (2725)..... Ryton (PPS), glass, UHMW PE, FKM,  
Platinum

pH (2734 & 2736)..... Ryton (PPS), glass, PTFE, FKM

ORP (2735)..... Ryton (PPS), glass, PTFE, FKM, Platinum

Shipping Weight..... 0.25 kg (0.55 lb)

### Performance

#### Efficiency

2724-2726..... > 97% @ 25 °C (77 °F)

2734-2736..... > 95% @ 25 °C (77 °F)

- Efficiency indicates the "wellness" of a new electrode.
- Efficiency is measured by comparing the actual slope (mV/pH) at 25 °C to the theoretical output of 59.16 mV/pH.
- An efficiency of 95% to 100% is equivalent to a slope of 56.20 to 59.16 mV/pH.

#### Measuring Range

pH..... 0 to 14

ORP..... ±2000 mV

3-2726-LC..... Low Conductivity fluids (20 to 100 µS/cm)  
≤ 20 µS/cm..... Flow must be less than 150 ml/min. in a  
properly grounded system

3-2724-HF, 3-2726-HF, 3-2734-HF, 3-2736-HF:

Hydrofluoric acid resistant glass, pH 6 or below; trace HF ≤ 2%

For applications where hydrofluoric acid, **in concentrations of 2% or less**, will attack standard pH glass in situations where process upsets may temporarily drop to these pH levels.

### Environmental Requirements

#### Operating Temperature

2724-2726\*..... -10 °C to 85 °C (14 °F to 185 °F)

2734-2736\*..... 10 °C to 100 °C (50 °F to 212 °F)

\*Best performance for 3-2724-HF, 3-2726-HF, 3-2734-HF,  
3-2736-HF is above 10 °C (50 °F)

**Note:** The Sensor Electronics must be remotely mounted when the temperature exceeds 85 °C (185 °F)

#### Operating Pressure Range

2724-2726:

- 0 to 6.9 bar (0 to 100 psi) @ -10 °C to 65 °C (14 °F to 149 °F)
- Linearity Derated 6.9 to 4.0 bar (100 to 58 psi) @ 65 °C to 85 °C (149 °F to 185 °F)

2734-2736:

- 0 to 6.9 bar (0 to 100 psi) @ 10 °C to 65 °C (50 °F to 149 °F)
- Linearity Derated 6.9 to 4.0 bar (100 to 58 psi) @ 65 °C to 100 °C (149 °F to 212 °F)

#### Recommended storage temperature

pH/ORP electrodes..... 0 °C to 50 °C (32 °F to 122 °F)



- The electrode glass will shatter if shipped or stored at temperatures below 0 °C (32 °F).
- The performance life of the electrode will be shortened if stored at temperatures above 50 °C (122 °F).

### Maximum Temperature and Pressure Rating

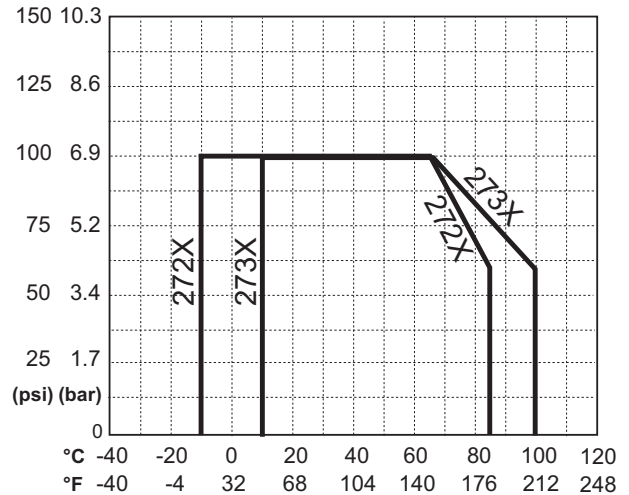

### Standards and Approvals

- CE, WEEE, RoHS Compliant
- Manufactured under ISO 9001 for Quality, ISO 14001 for Environmental Management and OHSAS 18001 for Occupational Health and Safety.



China RoHS (Go to [www.gfsignet.com](http://www.gfsignet.com) for details)



Declaration of Conformity according to FCC Part 15

This device complies with Part 15 of the FCC rules.

Operation is subject to the following two conditions:

- (1) This device may not cause harmful interference, and
- (2) This device must accept any interference received, including interference that may cause undesired operation.

**REACH Information Obligation:** in accordance with Article 33 of the European REACH Regulation (EC) No. 1907/2006, the substances Lead and Acrylamide are present in the glass matrix and as a polymerized gel respectively; in a concentration >0.1% (w/w). During normal use, the articles do not pose any risks and no additional information is required for safe use.

## In-Line Installation

1. The electrode can be mounted at any angle.
2. Avoid air pockets and sediment.
3. The fitting must place the electrode in the flow but must not bottom out in the pipe.
4. Select a Signet installation fitting (0.5" to 4" size range) for convenience. Lightly lubricate O-ring with a non-petroleum based lubricate (grease) compatible with the system.

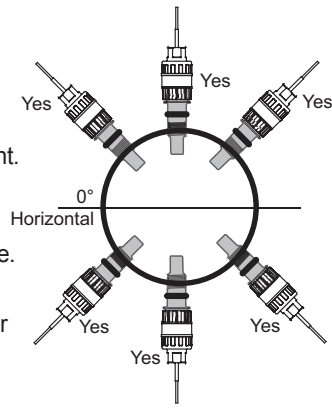

### NOTE:

When mounting in a standard threaded fitting, the electrode must be mounted horizontal to 60 degrees below horizontal position only:

5. Use the 3/4 in. M-NPT or ISO 7/1-R 3/4 threads on the electrode body to install the electrode into reducing tee fittings.
6. Inspect threads to ensure integrity. Do not install an electrode with damaged threads.
7. Apply PTFE tape to the M-NPT or ISO 7/1-R 3/4 process connection threads, in accordance with industry standards.
8. Use piping installation hardware with smooth, well-finished threads to facilitate the installation.
9. If necessary, the pipe should be plumbed with a depression (trap) so liquid is maintained around the electrode tip.
10. Hand-tighten the electrode into the process connection. Do not use any tools to install the electrode. The use of wrenches, pliers or similar may over-stress the sensor body and lead to breakage and subsequent spillage of the process liquid.

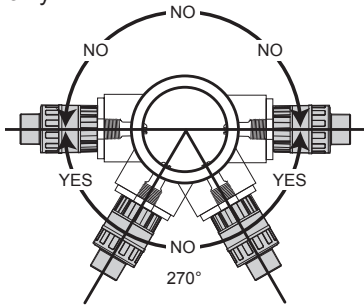

### CAUTION:



A broken sensor may be ejected forcefully from the fitting and can cause severe injury.

11. The safety instructions have an adhesive label and should be placed near the sensor.



## Low Conductivity Installation

- The 3-2726-LC pH electrodes can be used in low conductivity water of less than 100  $\mu$ S.
- When used in the range of 20 to 100  $\mu$ S, the flow range must not exceed 1 m/s (3 ft/s) velocity.
- When used in liquids of less than 20  $\mu$ S, the flow range must not exceed 150 ml/min; the sensor should also be mounted in a well grounded cell.

3-2751-X  
3-2760-X  
Submersible  
Pre-amplifier

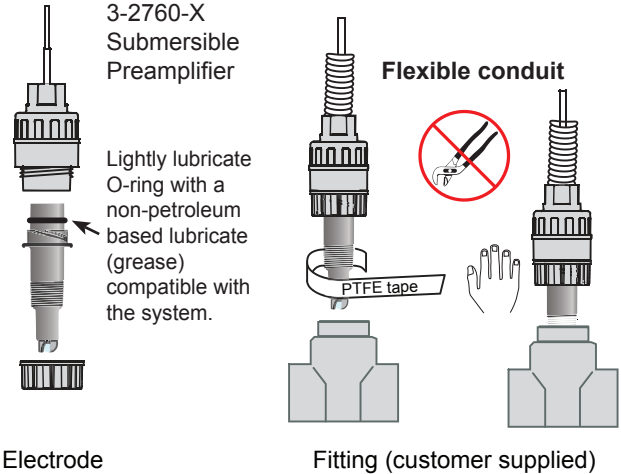

3-2751-X,  
3-2760-X1  
In-Line  
Pre-amplifier

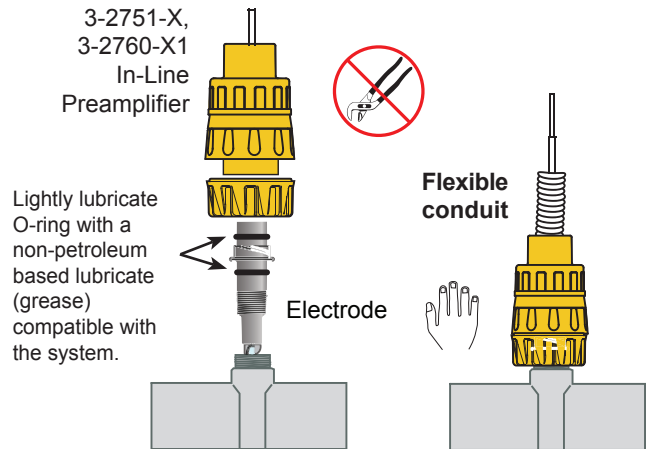



Signet Installation Fitting DN15 to DN100 (1/2 in. to 4 in.)

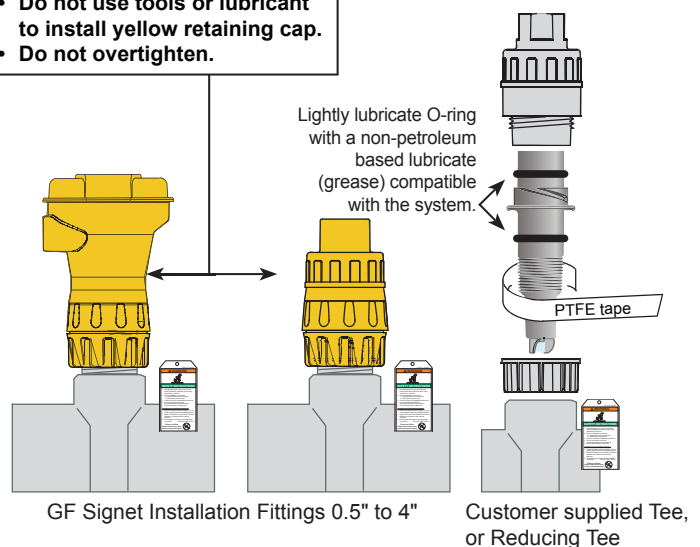

### Do not use as a handle!

- Do not use tools or lubricant to install yellow retaining cap.
- Do not overtighten.



## Signet Installation Fittings

Type	Description
 <p>Plastic tees</p>	<ul style="list-style-type: none"> <li>Available in ½ in. to 4 in. sizes</li> <li>PVC, CPVC w/solvent cement socket</li> <li>PVDF or PP w/union end fittings</li> </ul>
 <p>PVC saddles</p>	<ul style="list-style-type: none"> <li>Available in 2 in. to 4 in. sizes</li> <li>Requires 1-7/16 in. hole in pipe</li> </ul>
 <p>Iron strap-on saddles</p>	<ul style="list-style-type: none"> <li>Available in 2 in. to 4 in. sizes</li> <li>Requires 1-7/16 in. hole in pipe</li> </ul>

Type	Description
 <p>Carbon steel weldolets</p>	<ul style="list-style-type: none"> <li>Available in 2 in. to 4 in. sizes</li> <li>Requires 1-7/16 in. hole in pipe</li> <li>Install by certified welder only</li> </ul>
 <p>Carbon steel threaded tees</p>	<ul style="list-style-type: none"> <li>Available in ½ in. to 2 in. sizes</li> <li>Female NPT ends</li> </ul>
 <p>Universal pipe adapters</p>	<ul style="list-style-type: none"> <li>Use for installation in pipes &gt;4 in. (1¼ in. NPT)</li> <li>PVC, CPVC, or PVDF versions</li> <li>Specify socket or 1¼ inch NPT male threads</li> <li>Contact factory for support</li> </ul>

## Removing from In-Line Installation

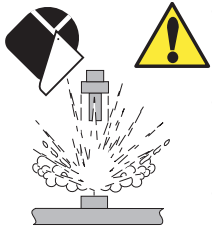

- The use of this product assumes that operators are trained and are familiar with this type of device.
- They should be knowledgeable of the potential risks associated with pressurized piping systems.
- Operators MUST follow all necessary safety procedures.

### In-line removal Instructions:

- Depressurize and vent the piping system.
- Drain the system to below sensor level.
- Wear safety goggles or face shield during removal. Use all appropriate eye, face, hand, body and/or respiratory protection when working with chemicals or solvents.
- Practice proper Lock Out/ Tag Out procedures when the sensor is removed for maintenance to prevent accidental opening and exposure to potentially hazardous chemicals.

## Submersible Installations

The user must supply the following hardware to complete a submersible installation:

- ¾ in. Pipe, ¾ in. (DN 20) Male Adapter, Liquid Tight Connection at top of pipe assembly
- Wiring junction box
- Pipe clamps (quick-release type recommended)
- Tank flange for closed tanks
- Silicone Caulking Sealant & PTFE Tape



### Technical Note:

- Mount the electrode near tank outlets, away from reagent addition areas.
- Use the ¾ in. (ISO 7/1-R ¾) threads at the top of the preamplifier to run the cable inside pipe or conduit.
- Place the electrode tip in pH 4 Buffer for temporary storage during system maintenance to avoid dehydration. For long term storage place the electrode tip in 3.0 mol/L KCl solution.

### 2724-2726 / 2734-2736 with 2751/2760 pH/ORP Sensor Electronics

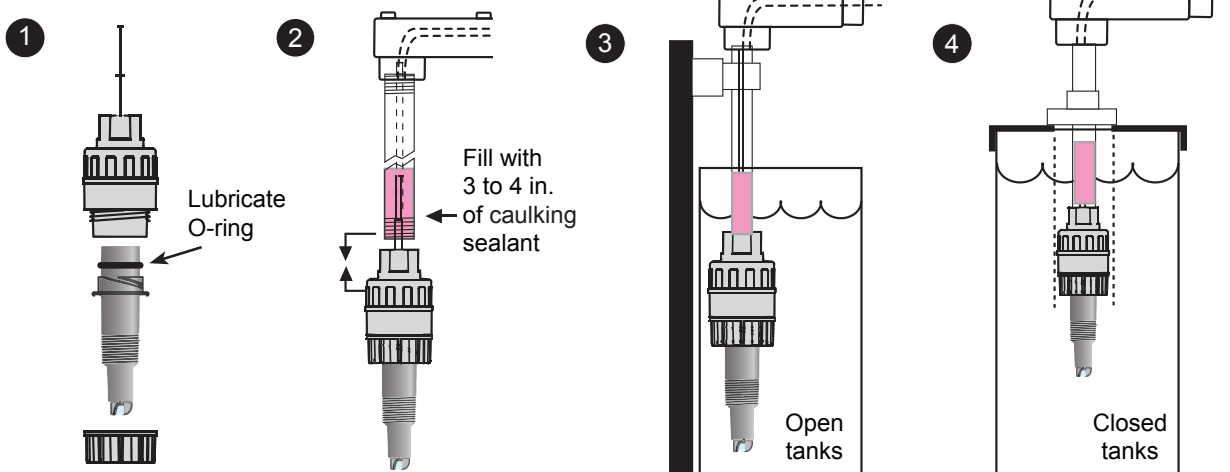

The Signet pH/ORP electrodes are designed to install in tanks by attaching conduit to the ¾ in. (ISO 7/1-R ¾) threads at the top of the accompanying preamplifier or sensor electronics:

- The O-ring at the top of the electrode fits very tightly into the preamplifier. Use a small amount of non-petroleum based lubricant to assist the assembly.
- To prevent moisture from migrating into the preamplifier, backfill the conduit with 3 in. to 4 in. of sealant.
- Mount electrodes in a location with ample clearance to remove them for periodic cleaning and recalibration.
- Choose a location that keeps the electrode glass completely submersed at all times.



## Electrode Date Code

- The electrode date code indicates the manufacturing date of the electrode.
- Electrodes should be put into service as soon as possible and should not remain in the box for more than two years.
- Over time, the storage solution (found in the "boot" covering the electrode tip) will evaporate or leak, allowing the delicate sensing tip and reference junction to dry.
- To rehydrate a dry electrode, soak the tip in 3.0 mol/L KCl solution for 24 to 48 hours. Preheating the KCl solution to <140 °F may speed up the re-hydration process.
- Electrodes more than 2 years old may still be functional, but will take longer to rehydrate.
- Restoration may not be effective for severely dehydrated electrodes.

Letter = Month
N = January
M = February
L = March
K = April
J = May
H = June
G = July
F = August
E = September
D = October
C = November
B = December

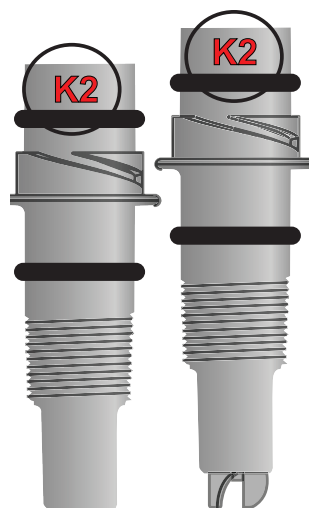

Numeral = Year
5 = 2010
6 = 2011
7 = 2012
8 = 2013
9 = 2014
0 = 2015
1 = 2016
2 = 2017
3 = 2018
4 = 2019
5 = 2020
6 = 2021

Example: K2 = manufactured in April 2017

## Electrode Care

Depending on the type of application and the accuracy needed, pH and ORP electrodes will require routine maintenance. Contaminated/dirty electrodes should be swapped with properly cleaned conditioned and calibrated electrodes.

The solution used to clean an electrode varies depending on the type of coating:

**Caution:** Always wear appropriate safety gear and exercise proper safety practices when working with or near chemicals

- General Cleaning** – Soak the electrode for 5 minutes in a mixture of warm tap water (< 140° F), and mild detergent such as liquid dish detergent. A soft brush, like a toothbrush may also be used to clean off particulates.
- Biofilm and bacterial growth** – Soak the electrode in a diluted household laundry bleach solution (pH electrodes only), 1part bleach to 10 parts water for 10 minutes.
- Alkaline or Scale** – Lime/calcium and mineral buildup deposits may be removed by soaking the electrode in a solution of 2% to 5% hydrochloric acid (HCl) or vinegar for no more than 5 minutes.
- Acidic contaminants** – May be removed by soaking the electrode in a weak caustic (less than 2% to 5% NaOH) for a few minutes only. Use the least harsh chemical which will remove the contaminant within 2-5 minutes of soaking without attacking the materials of construction.
- Oily or organic coatings** – Soak the probe for 5 to 10 minutes in a solution of warm tap water < 140° F, and dish detergent. Alternatively, use an appropriate solvent (isopropyl alcohol or similar) that will not attack the materials of construction. If required gently clean junction and/or glass with a very soft tooth brush, and follow up with brief soaking (2-5 minutes) in 2% to 5% NaOH (sodium hydroxide). In the case of pH (not ORP) a difficult organic fouling can be treated with household bleach (4-6%) as a substitute for the dish detergent.
- ORP Platinum Coating** – Gently wipe the electrode surface with a soft lint-free paper towel. If the various forms of chemical cleaning are not sufficient to achieve an accurate measurement and response time, a last resort would be to polish the platinum surface with a 0.3-1.0 micron alumina polishing slurry to remove any stubborn coatings.
- After cleaning, rinse pH/ORP electrode in distilled or tap water, then re-examine the electrode for damage that may have been hidden from view. Sensor may not initially behave properly; and have a temporary offset due to the cleaning chemistry. Proper conditioning is always recommended.

## Electrode Conditioning

Soak sensor tip (pH or ORP) in 3 mol/L KCl (potassium chloride), for at least 45 minutes to regenerate/condition.

The more aggressive the cleaning, the longer the soak in potassium chloride.

Failure to soak the electrode will cause the electrode to drift for a time after the cleaning procedure, and could adversely affect the calibration process/results.

If the cleaning and conditioning yield results within operational tolerance, the pH/ORP sensor is once again suitable for use. However, if the results do not bring the readings of the pH/ORP sensor within tolerance, it is time to replace the sensor.

## pH System Calibration

There are two functions in a pH electrode that require the system to be calibrated:

### Temperature Calibration

- The temperature output of the electrode (measured by a 3K $\Omega$  Balco or Pt1000 RTD) must be calibrated only once. When a new electrode is installed, it does not need to be repeated.
- Because the temperature measurement has a significant influence on the electrochemical measurement, the temperature output in new pH electrodes should always be calibrated before the pH/mV calibration.

**NOTE:** All Signet transmitters and controllers incorporate automatic temperature compensation.

pH error due to temperature changes in fluid											
°C	pH 2	pH 3	pH 4	pH 5	pH 6	pH 7	pH 8	pH 9	pH 10	pH 11	pH 12
15	0.15	0.12	0.09	<b>**0.06</b>	0.03	0	0.03	0.06	0.09	0.12	0.15
25	0	0	0	<b>* 0</b>	0	0	0	0	0	0	0
35	0.15	0.12	0.09	0.06	0.03	0	0.03	0.06	0.09	0.12	0.15
45	0.3	0.24	0.18	0.12	0.06	0	0.06	0.12	0.18	0.24	0.3
55	0.45	0.36	0.27	0.18	0.09	0	0.09	0.18	0.27	0.36	0.45

Table 1

As the pH value moves away from neutral (7 pH) or the temperature moves away from 25 °C, the electrochemical output is affected.

\* Example: At pH 5 the mV output of the electrode is not affected if the temperature is at 25 °C.

\*\* The electrode output will be shifted by 0.06 pH units if the temperature is reduced to 15 °C.

### Offset and Slope Calibration

The pH electrode calibration is an important function that must be done routinely to standardize the electrode due to its ever-changing characteristics. The electrode contains a gel that depletes over time, so the instrument must be readjusted periodically to maintain system accuracy. There are many influences, including aging, temperature, coatings and chemicals used that will affect the probe characteristics. After cleaning and conditioning, Signet pH electrodes may be calibrated in two pH buffer solutions of different pH values (a two point calibration).

The pH electrode is calibrated by placing it in a buffer solution of known pH and measuring the cell potential. This is a linear function of pH in the range of pH 2-11, therefore two calibration points are needed. Most common calibration buffers are pH 4.01 and pH 7.00 (@ 25 °C). If the pH measurements are made in an acid to neutral range, we recommend using buffer pH 4.01 and buffer pH 7.00 for calibration. If an alkaline sample is measured, we recommend using buffer 7.00 and buffer 10.01 for calibration.

The response of the glass electrode is characterized by two parameters, offset and slope. The theoretical output of a pH electrode at pH 7 is 0 mV. The offset, or zero pH is the deviation of the pH from the nominal value. In the Signet transmitters, the offset calibration is performed under STANDARD.

The glass electrode slope is the mV developed per each pH unit (mV/pH). At 25 °C, the theoretical slope is 59.16 mV/pH. So, at pH 4.01, +177 mV will be generated, while at pH 10.01 (with a lower H<sup>+</sup> concentration), a potential of -177 mV will be generated, (see Table 2). A new electrode however, will generate 0 ± 15 mV in pH 7.00 and will have a slope efficiency between 93.2 and 103%. In the Signet transmitters, manual slope calibration is performed under SLOPE.

Theoretical mV Values @ 25 °C	
pH	mV
2	+295.8
3	+236.64
4	+177.48
5	+118.32
6	+59.16
7	0
8	-59.16
9	-118.32
10	-177.48
11	-236.64
12	-295.8

Table 2

## pH System Calibration cont.

### How to calculate a pH electrode slope efficiency

Two pH buffers are selected to check the pH probe performance, pH 4.01 and pH 7.00. The ratio of the measured potentials (E2-E1) to the difference of pH (7.00 – 4.01) gives the slope of the straight line.

1. Read the mV potential generated by the electrode in two calibration buffers
2. Determine the slope (the mV potential generated per pH unit)
3. Divide this number by the theoretical slope, 59.16 mV/pH @ 25 °C and multiply by 100.

#### Example 1

pH electrode generates -12 mV in pH 7.00 buffer and +162 mV in pH 4.01 buffer.

$$160 \text{ mV} - (-12 \text{ mV}) = 172 \text{ mV}$$

$$172 \text{ mV} / 3 = 57.33 \text{ mV/pH unit}$$

$$57.33/59.16 \times 100 = 96.9 \% \text{ slope efficiency}$$

#### Example 2

pH electrode generates -45 mV in pH 7.00 buffer and +115 mV in pH 4.01 buffer.

$$115 \text{ mV} - (-45 \text{ mV}) = 160 \text{ mV}$$

$$160 \text{ mV} / 3 = 53.33 \text{ mV/pH unit}$$

$$53.33/59.16 \times 100 = 90.1\%$$

In Example 2, slope efficiency of 90.1% is acceptable but the offset of -45 mV is not.

An offset shift can be the result of the reference electrode being contaminated or poisoned.

A slope shift can be the result of the glass being etched or coated with a hard build-up.

As the electrode ages, the slope decreases gradually, generally a slope between 85% and 105% is acceptable. If the offset value (pH 7.00) is > +/- 45 mV, electrode should be replaced. When a great accuracy is required from the electrode, the offset and the slope values need to be as close as possible to the theoretical values.

Refer to the Calibration Procedure section of the instrument manual for a 2 point pH calibration. If the sensor is used in a 4 to 20 mA 'blind application' refer to the Calibration section of the 2751 Smart Sensor Electronics for a 2-point EasyCal pH calibration.

## ORP System Calibration

**ORP electrodes do not incorporate a temperature sensor, so the only system calibration required is the electrochemical adjustment.**

ORP electrodes should need less frequent calibration than a typical pH sensor, the redox potential is a characteristic of the interaction between the platinum measuring electrode and the redox species in solution.

ORP measurement is only an indicator of the process solution reducing or oxidizing potential. Always perform a single point calibration (standardization). Using the 9900 or 9950 transmitter, this can be performed under STANDARD. Disregard the SLOPE calibration.

If calibrating the ORP electrode under EasyCal (9900 Transmitters, Gen IV or later), one point calibration will be your only option.

A new ORP electrode measures the listed value +/- 20 mV. A two-point calibration will not increase the accuracy of the measurement given the +/- 20 mV repeatability of the sensor itself. On top of that, the ORP is not temperature compensated, so if the measurement is not done at 25 °C, any benefit gained will be lost. A true two-point calibration is possible in very few applications where only one redox couple is present in solution and its chemistry is known.

Calibration should be done using ORP premade standard solutions such as Zobell's solution and Light's solution, or solutions made using the standard pH 4.01 buffer and pH 7.00 buffer with quinhydrone powder mixed in until saturation is reached (Table 3). If all the quinhydrone does dissolve, continue to add small amounts and stir until a small amount of quinhydrone remains un-dissolved after mixing. Quinhydrone is the oxidizer that is measured by the ORP electrode. Please note that Zobell's solution is not compatible with the AutoCal function in Signet ORP instrumentation.

Pre-packaged or mixed Quinhydrone solutions are strong and may have a long lasting effect on the electrode, therefore after calibration it's recommended to properly condition the electrode before returning to the process. It is also possible to calibrate the ORP electronics based upon a known grab sample confirmed with a lab meter.

Pick a solution with a mV value closest to the process value and if possible adjust the temperature of the solution to the process temperature to minimize the offset.

The ORP electrode is functional until the offset exceeds 50 mV.

When the offset measures greater than 50 mV, the electrode should be replaced.

**Table 3:**  
ORP test solutions

\*Saturate 50 mL of pH 4 or pH 7 buffer with 1/8 g quinhydrone

	Zobell's solution	Light's solution	4 pH buffer w/quinhydrone*	7 pH buffer w/quinhydrone*
ORP at 20 °C			268 mV	92 mV
ORP at 25 °C	228 mV	469 mV	263 mV	86 mV
ORP at 30 °C			258 mV	79 mV



## Buffer Solutions

Proper handling, storage and use of buffers is very important on the pH and ORP measurement accuracy. If the buffers are contaminated or used improperly, the calibration will be inaccurate and all subsequent measurements will be wrong.

- When calibrating pH electrodes, always use pH buffers in the range of your sample.
- To achieve an accurate calibration make sure the electrode and the buffer are at the same temperature.
- Buffers have limited shelf life. Do not use a buffer if the expiration date has passed.
- Never return used buffers to the buffer bottle. Discard it.
- Do not leave the buffer bottle open (exposed to air).  
The atmospheric carbon dioxide lowers the pH of the alkaline buffers (10.01 pH).
- To avoid contamination, rinse the electrode with distilled or tap water before placing it in the buffer. If necessary, the electrode might be blotted dry using a lint-free paper towel (e.g. Kimwipes) to remove excess water. Be extra careful not to touch or rub the surface of the glass. The wiping of the glass can produce a static charge that will interfere with the voltage reading of the electrode. In addition to this, the hydration gel layer is interrupted.
- Store buffers at room temperature.
- Signet offers the following pH buffer solutions, pH 4.01, pH 7.00 and pH 10.01.
- Make fresh buffer solutions just before using. ORP solutions made with quinhydrone are very unstable and may not read properly after being exposed to air for a prolonged time. These solutions must be discarded after a few hours.
- Dispose of all calibration solutions in accordance with local guidelines and regulations.

## Electrode Storage

Proper electrode storage maximizes electrode performance and extends electrode life.

**Prior to storage** - add 3 mol/L KCl to the electrode storage cap (about half full), and carefully secure the cap onto the electrode tip.

- Store boxed electrodes wet, flat or upright (electrode tip down) to maximize hydration of the glass surface.
- Store electrodes in stable temperature environment, avoiding freezing conditions (below 0 °C (<33° F) and heat above 100° F).
- Never store the electrode in deionized (DI) water. Use 3 mol/L KCl solution to keep the glass wet when out of the process.

**Short term storage (up to 24 hours)** - soak the electrode tip in either pH 4.01 buffer or 3 mol/L KCl solution.

- Drying out of the pH sensitive glass and the junction must be avoided (or damage to the electrode will occur).
- Prior to electrode installation, make sure there's a light film of synthetic grease (such as silicone-free grease) applied to the upper electrode O-ring. If the electrode will be installed into a GF Signet Installation Fitting, then also apply a thin film of synthetic grease to the lower O-ring.

**Long term storage (longer than 24 hrs)** - add 3 mol/L KCl solution to the storage cap (about half full) and carefully secure the cap onto the electrode tip. This will ensure probes are always ready to use.



## Ordering Information

### 2724-2726 and 2734-2736 pH/ORP Electrodes

Mfr. Part No.	Code	Description
3-2724-00	159 001 545	pH Electrode, flat, Pt1000, 3/4 in. NPT
3-2724-01	159 001 546	pH Electrode, flat, Pt1000, ISO 7/1 R3/4
3-2724-10	159 001 547	pH Electrode, flat, 3K Balco, 3/4 in. NPT
3-2724-11	159 001 548	pH Electrode, flat, 3K Balco, ISO 7/1 R3/4
3-2724-HF-10	159 001 771	pH Electrode, HF resistant, flat, 3K Balco, 3/4 in. NPT
3-2724-HF-11	159 001 772	pH Electrode, HF resistant, flat, 3K Balco, ISO 7/1 R3/4
3-2726-00	159 001 553	pH Electrode, bulb, Pt1000, 3/4 in. NPT
3-2726-01	159 001 554	pH Electrode, bulb, Pt1000, ISO 7/1 R3/4
3-2726-10	159 001 555	pH Electrode, bulb, 3K Balco, 3/4 in. NPT
3-2726-11	159 001 556	pH Electrode, bulb, 3K Balco, ISO 7/1 R3/4
3-2726-HF-00	159 001 549	pH Electrode, HF resistant, bulb, Pt1000, 3/4 in. NPT
3-2726-HF-01	159 001 550	pH Electrode, HF resistant, bulb, Pt1000, ISO 7/1 R3/4
3-2726-HF-10	159 001 551	pH Electrode, HF resistant, bulb, 3K Balco, 3/4 in. NPT
3-2726-HF-11	159 001 552	pH Electrode, HF resistant, bulb, 3K Balco, ISO 7/1 R3/4
3-2726-LC-00	159 001 557	pH Electrode, bulb, Low Cond, Pt1000, 3/4 in. NPT
3-2726-LC-01	159 001 558	pH Electrode, bulb, Low Cond, Pt1000, ISO 7/1 R3/4
3-2726-LC-10	159 001 559	pH Electrode, bulb, Low Cond, 3K Balco, 3/4 in. NPT
3-2726-LC-11	159 001 560	pH Electrode, bulb, Low Cond, 3K Balco, ISO 7/1 R3/4
3-2725-60	159 001 561	ORP Electrode, platinum, flat, 10 KΩ ID, 3/4 in. NPT
3-2725-61	159 001 562	ORP Electrode, platinum, flat, 10 KΩ ID, ISO 7/1 R3/4
3-2734-00	159 001 774	pH Electrode, flat, Pt1000, 3/4 in. NPT
3-2734-01	159 001 775	pH Electrode, flat, Pt1000, ISO 7/1 R3/4
3-2734-HF-00	159 001 776	pH Electrode, HF resistant, flat, Pt1000, 3/4 in. NPT
3-2734-HF-01	159 001 777	pH Electrode, HF resistant, flat, Pt1000, ISO 7/1 R3/4
3-2736-00	159 001 778	pH Electrode, bulb, Pt1000, 3/4 in. NPT
3-2736-01	159 001 779	pH Electrode, bulb, Pt1000, ISO 7/1 R3/4
3-2736-HF-00	159 001 780	pH Electrode, HF resistant, bulb, Pt1000, 3/4 in. NPT
3-2736-HF-01	159 001 781	pH Electrode, HF resistant, bulb, Pt1000, ISO 7/1 R3/4
3-2735-60	159 001 782	ORP Electrode, platinum, flat, 10 KΩ ID, 3/4 in. NPT
3-2735-61	159 001 783	ORP Electrode, platinum, flat, 10 KΩ ID, ISO 7/1 R3/4
3-2735-G-60	159 001 844	ORP Electrode, graphite, flat, 10 KΩ ID, 3/4 in. NPT
3-2735-G-61	159 001 845	ORP Electrode, graphite, flat, 10 KΩ ID, ISO 7/1-R3/4

## Ordering Information cont.

### Accessories and Replacement Parts

3-2751-1	159 001 804	In-line Smart Sensor Electronics with 4.6 m (15 ft) cable (recommended for use with 9900 or 9950)
3-2751-2	159 001 805	In-line Smart Sensor Electronics with Junction Box and EasyCal (recommended for current loop and 0486)
3-2751-3	159 001 806	Submersible Smart Sensor Electronics with 4.6 m (15 ft) cable, ¾ in. NPT threads
3-2751-4	159 001 807	Submersible Smart Sensor Electronics with 4.6 m (15 ft) cable, ISO 7/1-R¾ threads
3-2760-1	159 000 939	Submersible Preamplifier with ¾ in. NPT threads and 4.6 m (15 ft) cable
3-2760-2	159 000 940	Submersible Preamplifier with ¾ in. ISO threads and 4.6 m (15 ft) cable
3-2760-11	159 001 367	In-line Preamplifier with ¾ in. NPT threads and 4.6 m (15 ft) cable
3-2760-21	159 001 368	In-line Preamplifier with ¾ in. ISO threads and 4.6 m (15 ft) cable
3-2759	159 000 762	pH/ORP System Tester (adapter cable sold separately)
3-2759.391	159 000 764	2759 DryLoc Adapter Cable (for use with 2751 and 2760)
3-0700.390	198 864 403	pH Buffer Kit (1 each 4, 7, 10 pH buffer in powder form, makes 50 mL)
3822-7004	159 001 581	pH 4 buffer solution, pint (16 oz) (473 ml)
3822-7007	159 001 582	pH 7 buffer solution, pint (16 oz) (473 ml)
3822-7010	159 001 583	pH 10 buffer solution, pint (16 oz) (473 ml)
3822-7115	159 001 606	20 gram bottle Quinhydrone for ORP calibration
3-2700.395	159 001 605	Calibration kit: 3 Polypropylene cups, box used as cup stand, 1 pint pH 4.01, 1 pint pH 7.00
3-8050.390-1	159 001 702	Retaining Nut, Replacement, NPT, Valox®
3800-5000	159 838 107	3.0M KCl Storage Solution for pH and ORP, 1 pint (473 ml) bottle
3-2700.397	159 001 870	Protective cap for pH/ORP electrodes, 5 pieces
3-2700.398	159 001 886	O-ring lubricant kit (5 packs of Super Lube, 1cc each)



**Georg Fischer Signet LLC, 3401 Aero Jet Avenue, El Monte, CA 91731-2882 U.S.A. • Tel. (626) 571-2770 • Fax (626) 573-2057**  
**For Worldwide Sales and Service, visit our website: [www.gfsignet.com](http://www.gfsignet.com) • Or call (in the U.S.): (800) 854-4090**  
**For the most up-to-date information, please refer to our website at [www.gfsignet.com](http://www.gfsignet.com)**