

Rosemount™ 1408H Level Transmitter

Non-Contacting Radar



Safety messages

NOTICE

Read this manual before working with the product. For personal and system safety, and for optimum product performance, ensure you thoroughly understand the contents before installing, using, or maintaining this product.

For technical assistance, contacts are listed below:

Customer Central

Technical support, quoting, and order-related questions.

- United States - 1-800-999-9307 (7:00 am to 7:00 pm CST)
- Asia Pacific- 65 777 8211

North American Response Center

Equipment service needs.

- 1-800-654-7768 (24 hours a day — includes Canada)
- Outside of these areas, contact your local Emerson representative.

⚠ WARNING

Failure to follow safe installation and servicing guidelines could result in death or serious injury.

Ensure the transmitter is installed by qualified personnel and in accordance with applicable code of practice.

Inspection and maintenance of this equipment shall be carried out by suitably trained personnel, in accordance with the applicable standards and code of practice.

Use the equipment only as specified in this manual. Failure to do so may impair the protection provided by the equipment.

Repair, e.g. substitution of components, etc. may jeopardize safety and is under no circumstances allowed.

⚠ WARNING

Process leaks could result in death or serious injury.

Handle the transmitter carefully.

Install and tighten process connectors before applying pressure.

Do not attempt to loosen or remove process connectors while the transmitter is in service.

⚠ WARNING

Physical access

Unauthorized personnel may potentially cause significant damage to and/or misconfiguration of end users' equipment. This could be intentional or unintentional and needs to be protected against.

Physical security is an important part of any security program and fundamental to protecting your system. Restrict physical access by unauthorized personnel to protect end users' assets. This is true for all systems used within the facility.

⚠ CAUTION

Hot surfaces

The transmitter and process seal may be hot at high process temperatures. Allow to cool before servicing.



Contents

Chapter 1	Introduction.....	5
	1.1 Using this manual.....	5
	1.2 Open source licenses.....	5
	1.3 Product recycling/disposal.....	5
Chapter 2	Transmitter overview.....	7
	2.1 Measurement principle.....	7
	2.2 Process characteristics.....	7
	2.3 Vessel characteristics.....	8
	2.4 Application examples.....	8
	2.5 Components of the transmitter.....	10
	2.6 Easy integration with IO-Link.....	11
Chapter 3	Mechanical installation.....	13
	3.1 Safety messages.....	13
	3.2 Installation considerations.....	13
	3.3 Mounting preparations.....	19
	3.4 Mount transmitter on tank.....	25
Chapter 4	Electrical installation.....	31
	4.1 Safety messages.....	31
	4.2 Prepare the electrical connections.....	31
	4.3 Power up transmitter.....	34
Chapter 5	Configuration.....	35
	5.1 Safety messages.....	35
	5.2 Overview.....	35
	5.3 Connect the transmitter to the IO-Link.....	36
	5.4 Get started with your preferred configuration tool.....	36
	5.5 Perform the basic setup.....	39
Chapter 6	Operation and maintenance.....	41
	6.1 Safety messages.....	41
	6.2 View measurement data and events.....	41
	6.3 Enter the demonstration mode.....	43
	6.4 Replacing the O-ring.....	43
Chapter 7	Service and troubleshooting.....	45
	7.1 Safety messages.....	45
	7.2 Diagnostic messages.....	46
	7.3 Troubleshooting incorrect level readings.....	53
	7.4 Managing disturbance echoes.....	64

	7.5 Service and troubleshooting tools.....	66
	7.6 Service support.....	70
Appendix A	Specifications and reference data.....	71
	A.1 Performance specifications.....	71
	A.2 Functional specifications.....	73
	A.3 Physical specifications.....	77
	A.4 Dimensional drawings.....	80
Appendix B	Product certifications.....	81
	B.1 European directive information.....	81
	B.2 UK regulation information.....	81
	B.3 Ordinary location certification.....	81
	B.4 Telecommunication compliance.....	81
	B.5 FCC.....	82
	B.6 IC.....	82
	B.7 Radio Equipment Directive (RED) 2014/53/EU and Radio Equipment Regulations S.I. 2017/1206.....	83
	B.8 Radio/EMC Republic of Korea.....	84
	B.9 Additional certifications.....	84
Appendix C	Configuration parameters.....	86
	C.1 Menu tree.....	86
	C.2 Basic setup.....	87
	C.3 Digital output.....	88
	C.4 Analog output.....	91
	C.5 Geometry.....	93
	C.6 Advanced setup.....	95

1 Introduction

1.1 Using this manual

The sections in this manual provide information on installing, operating, and maintaining the Rosemount™ 1408H Level Transmitter – Non-Contacting Radar.

The sections are organized as follows:

[Transmitter overview](#) provides an introduction to theory of operation, a description of the transmitter, information on typical applications, and process characteristics.

[Mechanical installation](#) contains mechanical installation instructions.

[Electrical installation](#) contains electrical installation instructions.

[Configuration](#) provides instructions on configuration of the transmitter.

[Operation and maintenance](#) contains operation and maintenance techniques.

[Service and troubleshooting](#) provides troubleshooting techniques for the most common operating problems.

[Specifications and reference data](#) supplies reference and specification data.

[Product certifications](#) contains approvals and certifications information.

[Configuration parameters](#) provides extended information about the configuration parameters.

1.2 Open source licenses

This device uses open source software. Further information can be found in the [License Information Document](#) available at [Emerson.com/Rosemount](https://emerson.com/Rosemount).

1.3 Product recycling/disposal

Recycling of equipment and packaging should be taken into consideration and disposed of in accordance with local and national legislation or regulations.

Related information

[Service support](#)

2 Transmitter overview

2.1 Measurement principle

The Rosemount 1408H is a transmitter for continuous level measurements using fast-sweep Frequency Modulated Continuous Wave (FMCW) technology.

The transmitter continuously emits signal sweeps with a constantly varying frequency towards the product surface. Since the transmitter continuously changes the frequency of the transmitted signal, there will be a difference in frequency between the transmitted and the reflected signals (see Figure 2-1).

The frequency of the reflected signal is subtracted from the frequency of the signal transmitted at that moment, resulting in a low frequency signal which is proportional to the distance to the product surface. This signal is further processed to obtain fast, reliable, and highly accurate level measurements.

Figure 2-1: FMCW-method

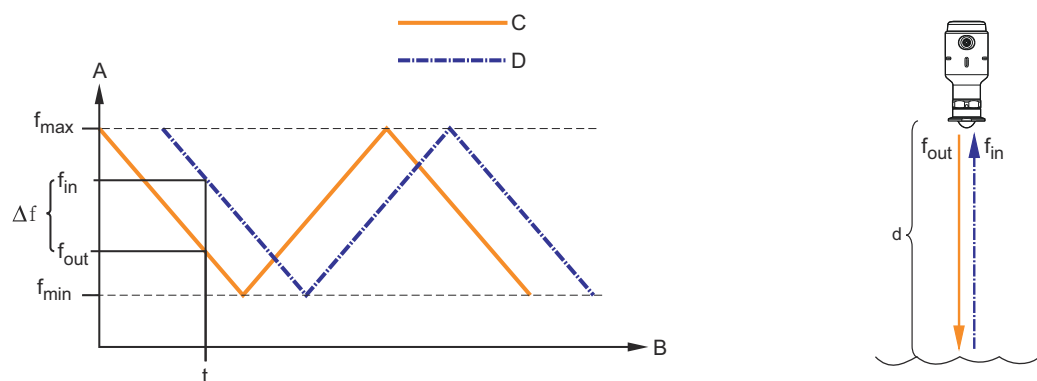

$\Delta f \sim d = \text{distance}$

- A. Frequency (GHz)
- B. Time (s)
- C. Transmitted signal
- D. Reflected signal

2.2 Process characteristics

2.2.1 Dielectric constant

A key parameter for measurement performance is reflectivity. A high dielectric constant of the media provides better reflection and enables a longer measuring range.

2.2.2 Foam and turbulence

Foaming liquids or turbulence may cause weak and varying surface echo amplitudes. Surface turbulence is not normally a problem unless it is excessive.

Measurement in foamy applications depends largely on the foam properties. When the foam is light and airy, the actual product level is measured. For heavy and dense foam, the transmitter may measure the level of the foam's upper surface.

2.3 Vessel characteristics

2.3.1 In-tank obstructions

The transmitter should be mounted so that objects such as heating coils, ladders, and agitators are not in the radar signal path. These objects may cause false echoes resulting in reduced measurement performance. However, the transmitter has built-in functions designed to reduce the influence from disturbing objects where such objects cannot be totally avoided.

Vertical and inclined structures cause minimal effect since the radar signal is scattered rather than directed back to the antenna.

2.4 Application examples

Non-contacting radar technology is ideal for applications in the hygienic industry as it is maintenance-free, has a top-down installation that reduces the risk of leakages, and is unaffected by process conditions such as density, viscosity, temperature, pressure, and pH.

The Rosemount 1408H uses Frequency Modulated Continuous Wave (FMCW) technology and smart algorithms to maximize measurement accuracy and reliability, even in small tanks and challenging fast-filling vessels.

Storage tank

Gain insights into your tank and ensure production runs smoothly without interruption.

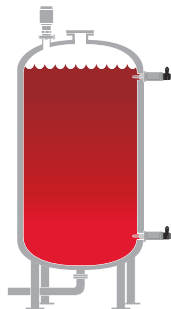

Mixing tanks

Ensure correct filling and storage levels in tanks with agitators.



Batch filling

Optimize the batch filling process.



CIP process

Reliable level measurement during and after cleaning, plus optimization of cleaning agent storage.



2.5 Components of the transmitter

Figure 2-2: Components

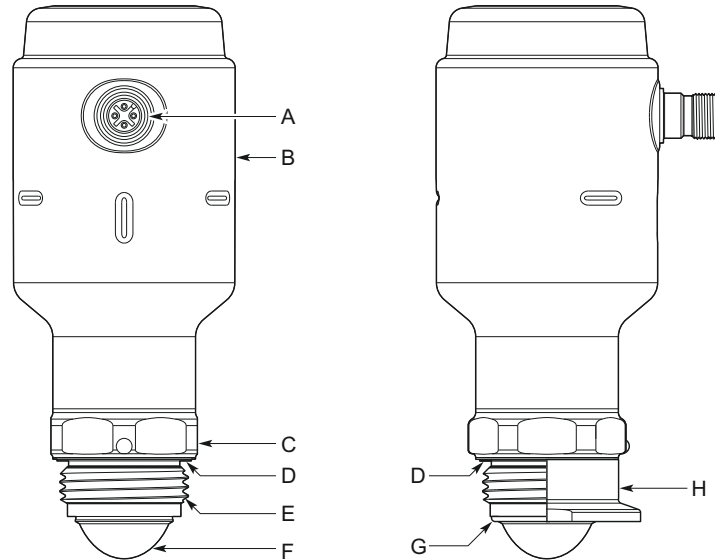

- A. M12 connector (A-coded)
- B. Transmitter housing (polished stainless steel)
- C. Wrench size: 39 mm
- D. DIN 3869 profile ring
- E. ISO 228/1-G1 thread
- F. Antenna (PTFE sealing)
- G. Hygienic adapter O-ring
- H. Hygienic process connection adapter

Figure 2-3: O-ring and Profile Ring

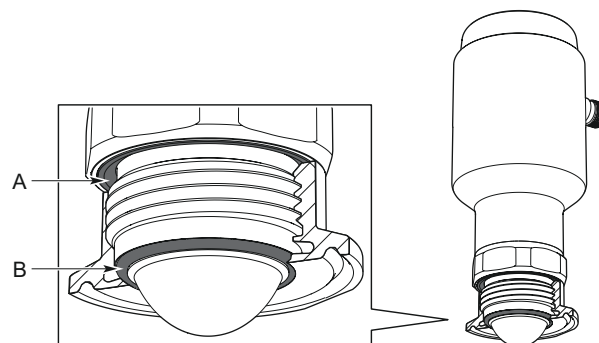

- A. DIN 3869 profile ring
- B. Hygienic adapter O-ring

Related information

[Dimensional drawings](#)

2.6 Easy integration with IO-Link

The Rosemount 1408H provides both conventional 4-20 mA and digital switch outputs, enabled by IO-Link connectivity. This supports easy integration into any automation system.

Each IO-Link system consists of an IO-Link master and one or more IO-Link devices (sensors and actuators). The connection between the master and the device is established via unshielded standard cables using standard connectors such as M12. Process data, events and parameters are transferred to the master via IO-Link. The IO-Link master then transfers the data to the controller (PLC) and its fieldbus or industrial ethernet network.

Figure 2-4: Example of an IO-Link System

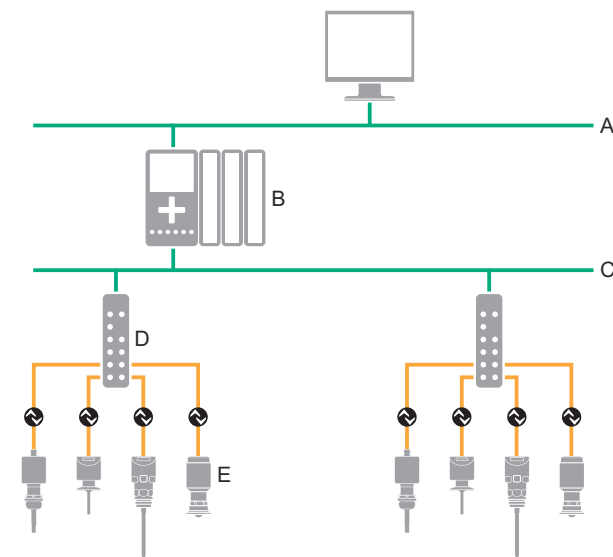

- A. Industrial ethernet
- B. Programmable logic controller (PLC)
- C. Industrial Fieldbus
- D. IO-Link master
- E. IO-Link devices

3 Mechanical installation

3.1 Safety messages

Instructions and procedures in this section may require special precautions to ensure the safety of the personnel performing the operations. Information that potentially raises safety issues is indicated by a warning symbol () . Refer to the following safety messages before performing an operation preceded by this symbol.

WARNING

Failure to follow safe installation and servicing guidelines could result in death or serious injury.

Ensure the transmitter is installed by qualified personnel and in accordance with applicable code of practice.

Inspection and maintenance of this equipment shall be carried out by suitably trained personnel, in accordance with the applicable standards and code of practice.

Use the equipment only as specified in this manual. Failure to do so may impair the protection provided by the equipment.

Repair, e.g. substitution of components, etc. may jeopardize safety and is under no circumstances allowed.

WARNING

Process leaks could result in death or serious injury.

Handle the transmitter carefully.

Install and tighten process connectors before applying pressure.

Do not attempt to loosen or remove process connectors while the transmitter is in service.

3.2 Installation considerations

Before installing the transmitter, follow recommendations for mounting position, sufficient free space, nozzle requirements, etc.

3.2.1 Mounting position

When finding an appropriate location on the tank for the transmitter, the conditions of the tank must be carefully considered.

Consider the following guidelines when mounting the transmitter:

- For optimal performance, the transmitter should be installed in locations with a clear and unobstructed view of the product surface.
- The transmitter should be mounted with as few internal structures as possible within the signal beam.
- Do not mount close to or above the inlet stream.
- Do not position the transmitter directly over a side manway door.
- Multiple Rosemount 1408H transmitters can be used in the same tank without interfering with each other.

Figure 3-1: Recommended Mounting Position

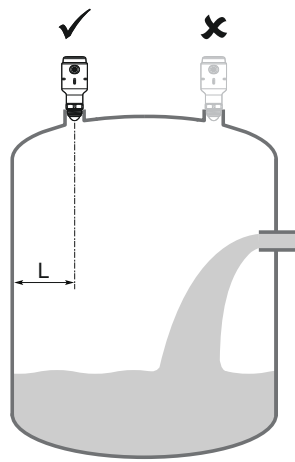

3.2.2 Free space requirements

If the transmitter is mounted close to a wall or other tank obstruction such as heating coils and ladders, noise might appear in the measurement signal. See [Table 3-1](#) for recommended clearance.

Figure 3-2: Free Space Requirements

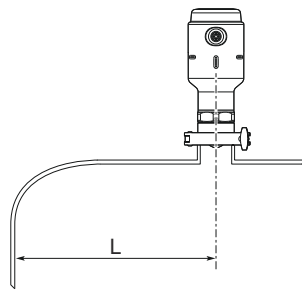

Table 3-1: Distance to Tank Wall (L)

Minimum	Recommended
8 in. (200 mm)	½ of tank radius

3.2.3 Inclination

The transmitter should be mounted vertically to ensure a good echo from the product surface. See [Figure 3-3](#) for recommended maximum inclination.

Figure 3-3: Inclination

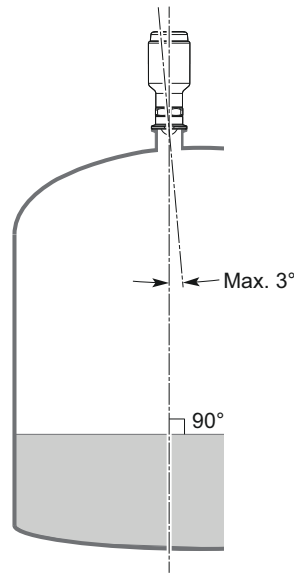

3.2.4 Non-metallic tanks

Nearby objects outside the tank may cause disturbing radar echoes. Wherever possible, the transmitter should be positioned so that objects close to the tank are kept outside the signal beam.

Related information

[Telecommunication compliance](#)

3.2.5 Beam angle and beam width

The transmitter should be mounted with as few internal structures as possible within the signal beam.

Figure 3-4: Beam Angle and Beam Width

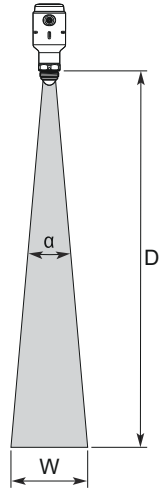

Beam angle (α)

10°

Beam width

See [Table 3-2](#) for beam width at different distances.

Table 3-2: Beam Width

Distance (D)	Beam width (W)
6.6 ft. (2 m)	1.2 ft. (0.4 m)
13.1 ft. (4 m)	2.3 ft. (0.7 m)
19.7 ft. (6 m)	3.5 ft. (1.1 m)
26.2 ft. (8 m)	4.6 ft. (1.4 m)
32.8 ft. (10 m)	5.8 ft. (1.8 m)

3.2.6 Nozzle requirements

To allow the microwaves to propagate undisturbed, the nozzle dimensions should be kept within the specified limits as given in [Table 3-3](#). The inside of the nozzle must be smooth (i.e. avoid bad welding, rust, or deposit).

Figure 3-5: Mounting in Nozzles

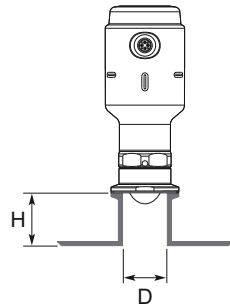

Table 3-3: Nozzle Requirements

Nozzle diameter (D)	Maximum nozzle height (H)
1 in. (25 mm)	3.9 in. (100 mm)
1.5 in. (40 mm)	5.9 in. (150 mm)
2 in. (50 mm)	7.9 in. (200 mm)
3 in. (80 mm)	11.8 in. (300 mm)
4 in. (100 mm)	15.8 in. (400 mm)
6 in. (150 mm)	23.6 in. (600 mm)

For 3-A[®] applications, the allowed nozzle height is further restricted to ensure cleanability.

Table 3-4: Nozzle Height in 3-A Applications

Standard	Maximum nozzle height (H)
3-A	Must not exceed 2 x nozzle diameter (D) nor 5 in. (127 mm)

3.2.7 Mounting onto a threaded connection

Refer to [Figure 3-6](#) for the required thread engagement length at the customer G1 process connection.

Figure 3-6: Thread Engagement Length

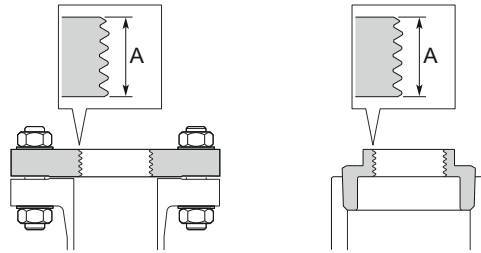

A. 0.35 to 0.63 in. (9 to 16 mm)

Related information

[Dimensional drawings](#)

3.2.8 Instructions for hygienic installations

To conform with applicable hygienic standards and food and beverage legislation and regulations, the Rosemount 1408H must be:

- Installed in a closed tank.
- Installed with hygienic adapter and O-ring.

It is the responsibility of the user to ensure:

- The materials listed in [Materials of construction](#) are suitable for the media and cleaning/sanitizing processes.
- The installation of the transmitter is drainable and cleanable.
- That the joint/clamping between the transmitter and the nozzle is compatible with the tank pressure and media.
- That for the application a suitable M12 connector is used and with appropriate ingress protection.

Related information

[Materials of construction](#)

Specific requirements for 3-A®

- The hygienic adapter must be 3-A certified and approved for use with the transmitter.
- Fittings and connections must comply with the requirements of 3-A Sanitary Standard 63-.
- On the “product contact side”, correct gasket variants shall be used and be made of 3-A compliant product contact material.

Clean-In-Place (CIP)

Withstands cleaning routines up to 194 °F (90 °C)

Steam-In-Place (SIP)

Withstands cleaning routines up to 284 °F (140 °C)

3.2.9 Hygienic adapter O-ring

The adapter comes with an EPDM O-ring. More O-rings are available as accessories.

Related information

[Product Data Sheet](#)

3.3 Mounting preparations

3.3.1 Remove the protective cap

The protective cap protects the PTFE sealing from impacts during transport and storage.

Procedure

Before installing, carefully remove the protective cap.

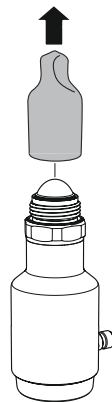

Note

Be careful not to scratch or otherwise damage the PTFE sealing.

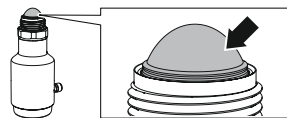

3.3.2 Tri Clamp, dairy coupling, and VARIVENT[®]

Install the adapter

Procedure

1. Place the O-ring in the groove of the transmitter.

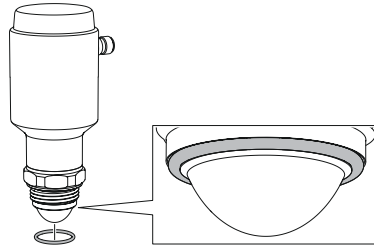

Note

Be careful not to scratch or otherwise damage the PTFE sealing.

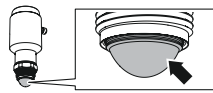

2. Apply lubricating paste on the transmitter thread.

Note

The paste must be approved for the application and compatible with the elastomers used.

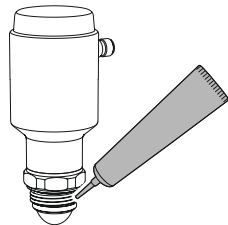

3. (Only for DIN 11851) Slide the coupling nut up over the bottom of the transmitter.

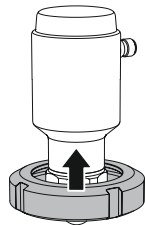

4. Screw the adapter onto the transmitter until it is hand-tight.

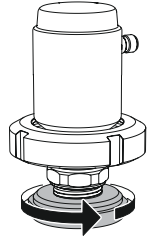

5. Secure the transmitter and adapter using a vise.

⚠ CAUTION

Do not over-tighten the vise as it might damage the adapter.

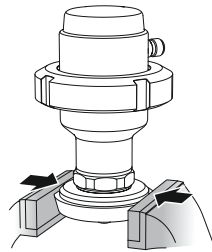

6. Tighten the transmitter to the recommended torque.

Note

Further tightening may affect the sealing.

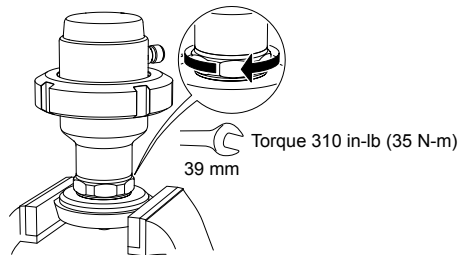

3.3.3 Weld-in adapter

Mount the welding mandrel

The welding mandrel absorbs heat and can prevent warping during installation of the weld-in adapter.

Prerequisites

⚠ CAUTION

While welding, the weld-in adapter and mandrel can get extremely hot. To prevent burns, allow the components to cool before disassembling the weld-in adapter and mandrel assembly.

Procedure

1. Hand-tighten the weld-in adapter.

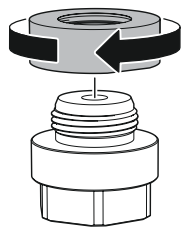

2. Insert the bolt through mandrel opening.

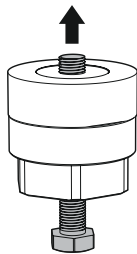

3. Mount the counter plate.

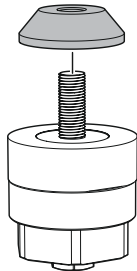

4. Tighten the nut.

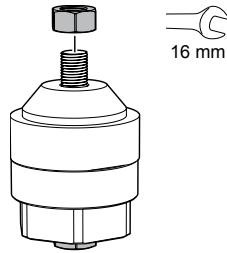

Postrequisites

1. Install the weld-in adapter.
2. Allow the weld and mandrel components to cool, then remove the mandrel components from the weld-in adapter.

Related information

[Install the weld-in adapter](#)

Install the weld-in adapter

Prerequisites

After welding, allow the adapter to cool before installing. Do not weld the adapter to the container or pipe with the transmitter connected.

Procedure

1. Weld the adapter.

Note

While welding, prevent the adapter from warping.

- a) Fix the adapter in several spots with a sufficient adhesive force. Apply the fixing points at equal distances opposite each other.

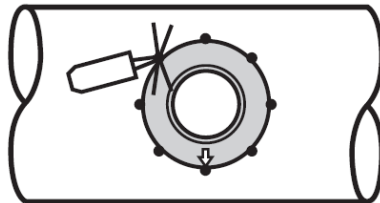

- b) Apply the welding seams between the fixing points opposite each other.
Ensure sufficient and even distance between the individual sections to avoid glowing through or warping of the adapter caused by overheating.

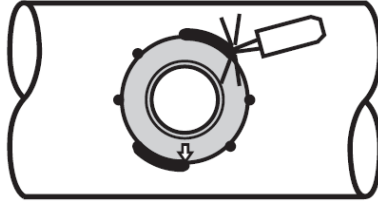

2. Allow the adapter to cool.
3. If used, remove the welding mandrel.
4. Remove deposits from the thread.

3.4 Mount transmitter on tank

3.4.1 Mount the Tri Clamp version

Procedure

1. Place a suitable gasket on top of the tank flange.

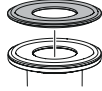

2. Lower the transmitter into the nozzle.

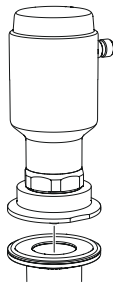

Note

Be careful not to scratch or otherwise damage the PTFE sealing.

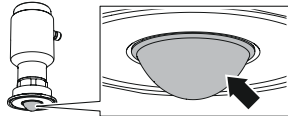

3. Tighten the clamp to the recommended torque (see the manufacturer's instruction manual).

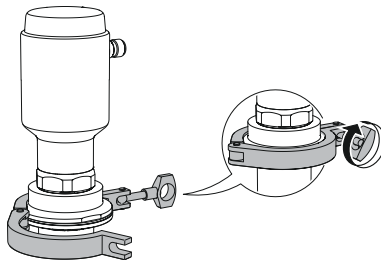

3.4.2 Mount the dairy coupling (DIN 11851)

Procedure

1. Place a suitable gasket on top of the tank flange.

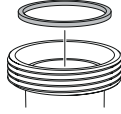

2. Lower the transmitter into the nozzle.

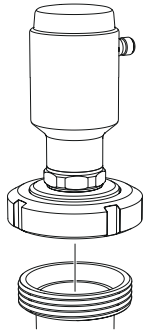

Note

Be careful not to scratch or otherwise damage the PTFE sealing.

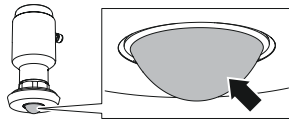

3. Tighten the lock nut to the recommended torque (see the manufacturer's instruction manual).

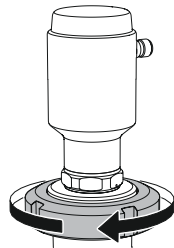

3.4.3 Mount the VARIVENT[®] version

Procedure

1. Mount a suitable O-ring on the adapter.

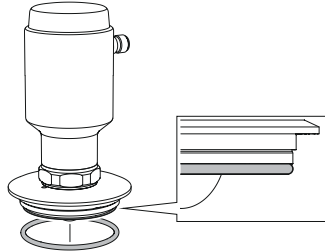

2. Lower the transmitter into the nozzle.

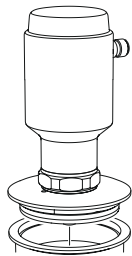

Note

Be careful not to scratch or otherwise damage the PTFE sealing.

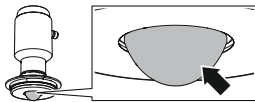

3. Tighten the clamp to the recommended torque (see the manufacturer's instruction manual).

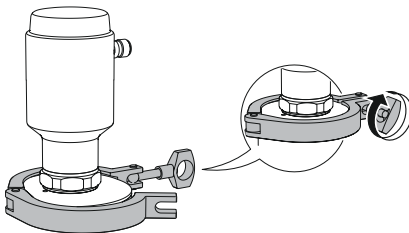

3.4.4 Mount on a threaded connection

Procedure

1. Apply lubricating paste on the transmitter thread.

Note

The paste must be approved for the application and compatible with the elastomers used.

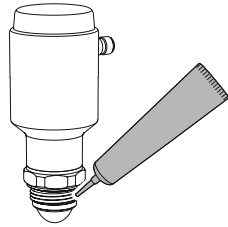

2. Mount the transmitter on the tank.

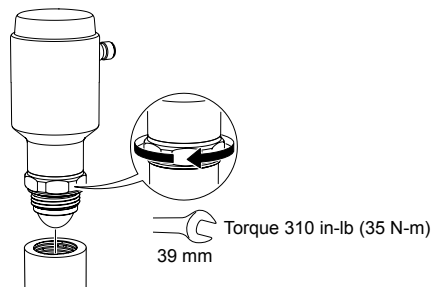

Note

Be careful not to scratch or otherwise damage the PTFE sealing.



3.4.5 Mount the weld-in adapter version

Procedure

1. Place the O-ring in the groove of the transmitter.

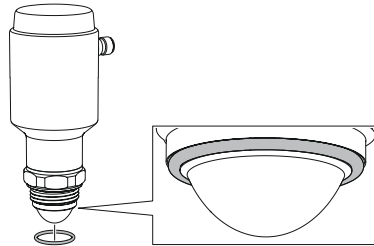

Note

Be careful not to scratch or otherwise damage the PTFE sealing.

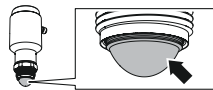

2. Apply lubricating paste on the transmitter thread.

Note

The paste must be approved for the application and compatible with the elastomers used.

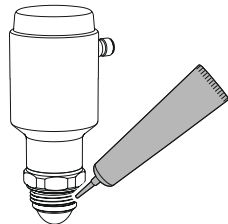

3. Tighten the transmitter to the recommended torque.

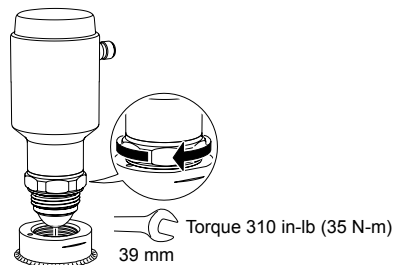

Note

Over tightening the transmitter can impair the seal. If the sealing areas are damaged, replace the O-ring or the entire process connector.

4 Electrical installation

4.1 Safety messages

Instructions and procedures in this section may require special precautions to ensure the safety of the personnel performing the operations. Information that potentially raises safety issues is indicated by a warning symbol ()¹). Refer to the following safety messages before performing an operation preceded by this symbol.

WARNING

Failure to follow safe installation and servicing guidelines could result in death or serious injury.

Ensure the transmitter is installed by qualified personnel and in accordance with applicable code of practice.

Inspection and maintenance of this equipment shall be carried out by suitably trained personnel, in accordance with the applicable standards and code of practice.

Use the equipment only as specified in this manual. Failure to do so may impair the protection provided by the equipment.

Repair, e.g. substitution of components, etc. may jeopardize safety and is under no circumstances allowed.

WARNING

Process leaks could result in death or serious injury.

Handle the transmitter carefully.

Install and tighten process connectors before applying pressure.

Do not attempt to loosen or remove process connectors while the transmitter is in service.

4.2 Prepare the electrical connections

4.2.1 Connector type

M12 (A-coded)

4.2.2 Power supply

The transmitter operates on 18-30 Vdc at the transmitter terminals.

Related information

[Load limitations](#)

4.2.3 Outputs

The transmitter provides two configurable outputs:

Output 1 Digital output / IO-Link mode

Output 2 Digital output or active 4-20 mA analog output

4.2.4 Internal power consumption

< 2 W (normal operation at 24 Vdc, no outputs)

< 3.6 W (normal operation at 24 Vdc, digital and analog outputs active)

4.2.5 Wiring diagram

Figure 4-1: Connection

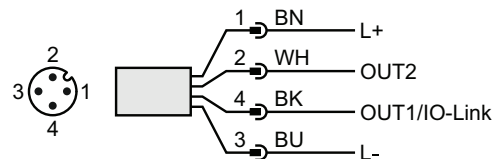
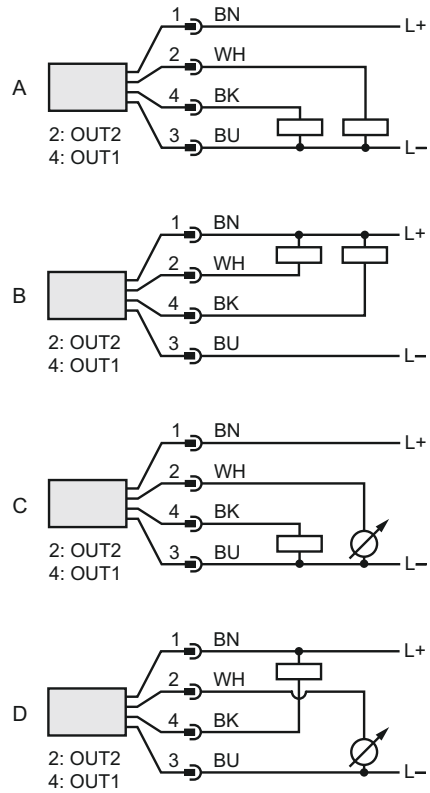

Table 4-1: Pin Assignment

Pin	Wire color ⁽¹⁾		Signal	
1	BN	Brown	L+	24 V
2	WH	White	OUT2	Digital output or active 4-20 mA analog output
3	BU	Blue	L-	0 V
4	BK	Black	OUT1/IO-Link	Digital output or IO-Link mode

⁽¹⁾ According to IEC 60947-5-2.

Figure 4-2: Example Circuits



- A. 2 x Digital output PnP
- B. 2 x Digital output NpN
- C. 1 x Digital output PnP / 1 x Analog output
- D. 1 x Digital output NpN / 1 x Analog output

Related information

[Outputs](#)

4.3 Power up transmitter

Prerequisites

Procedure

1. ⚠ Verify the power supply is disconnected.
2. Insert the M12 connector and screw tight.
See the manufacturer's instruction manual for recommended torque.

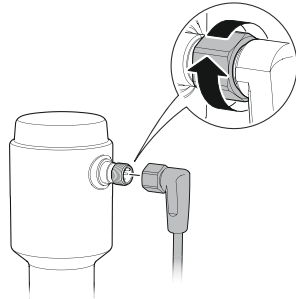

3. Connect the power supply.

Related information

[Ingress protection](#)

5 Configuration

5.1 Safety messages

Instructions and procedures in this section may require special precautions to ensure the safety of the personnel performing the operations. Information that potentially raises safety issues is indicated by a warning symbol (⚠). Refer to the following safety messages before performing an operation preceded by this symbol.

⚠ WARNING

Failure to follow safe installation and servicing guidelines could result in death or serious injury.

Ensure the transmitter is installed by qualified personnel and in accordance with applicable code of practice.

Inspection and maintenance of this equipment shall be carried out by suitably trained personnel, in accordance with the applicable standards and code of practice.

Use the equipment only as specified in this manual. Failure to do so may impair the protection provided by the equipment.

Repair, e.g. substitution of components, etc. may jeopardize safety and is under no circumstances allowed.

⚠ WARNING

Process leaks could result in death or serious injury.

Handle the transmitter carefully.

Install and tighten process connectors before applying pressure.

Do not attempt to loosen or remove process connectors while the transmitter is in service.

5.2 Overview

This chapter provides information about configuration and configuration tools. Appendix [Configuration parameters](#) provides extended information about the configuration parameters.

5.3 Connect the transmitter to the IO-Link

IO-Link devices can be set using an IO-Link USB Communicator, through the IO-Link master, or via the PLC.

Procedure

Start the configuration software and connect the transmitter.

Figure 5-1: Connection via the IO-Link USB Communicator

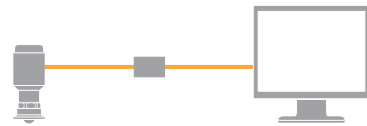

Figure 5-2: Connection via the IO-Link Master

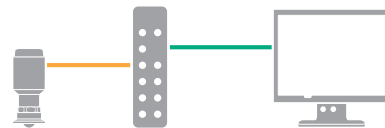
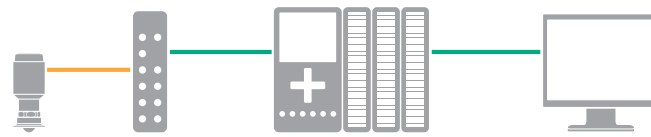

Figure 5-3: Connection via the PLC



5.4 Get started with your preferred configuration tool

5.4.1 IO-Link configuration tools

Examples:

- Rosemount IO-Link Assistant (available as accessory)
- FDT® frame applications, e.g. PACTware

5.4.2 Rosemount IO-Link Assistant

Get the latest IODD files

The Rosemount IO-Link Assistant software checks and lets you download the latest IODDs for your device catalog.

Prerequisites

For an online update, an internet connection is required.

Procedure

1. Click the  icon.
The **Device description files (IODD): download and install** window opens.
2. In the **Vendor** list, select **Rosemount Inc.**, and then select the check box for the devices to be installed/updated.
Alternatively, browse to an already downloaded IODD zip file, and select **Open**.

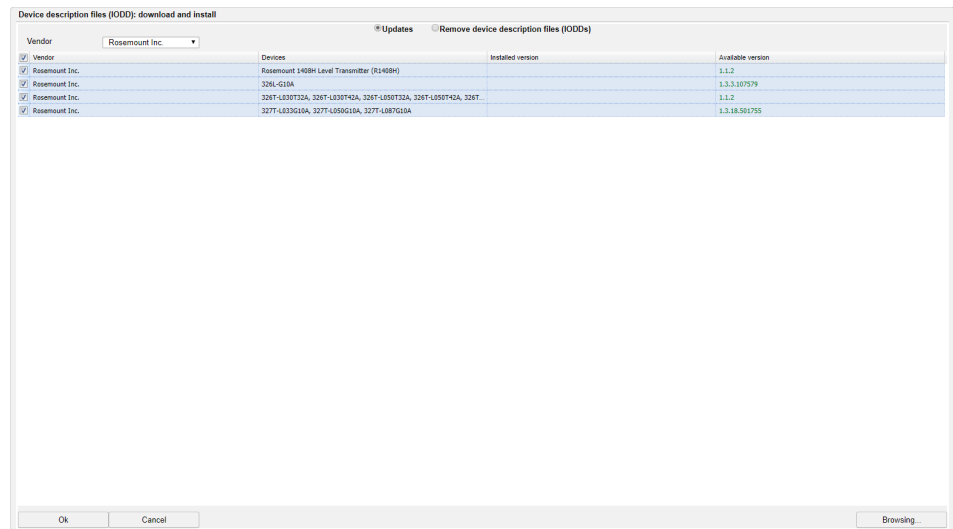

3. Select **OK**.

5.4.3 FDT®/DTM framework

Download the IODD file

Procedure

1. Download the IODD from the IODDFinder portal at loddfinder.io-link.com.
2. Unzip the IODD package.

Integrate IODDs into an FDT®/DTM framework

An IODD DTM Interpreter is required to integrate IODDs into an FDT/DTM environment (e.g PACTware).

Prerequisites

The IODD DTM Interpreter is usually included in the FDT/DTM software installation package. It can also be downloaded from Emerson.com/Rosemount1408H.

Procedure

1. Start the **IODD DTM Interpreter** software.

2. Select **Add IODD**.

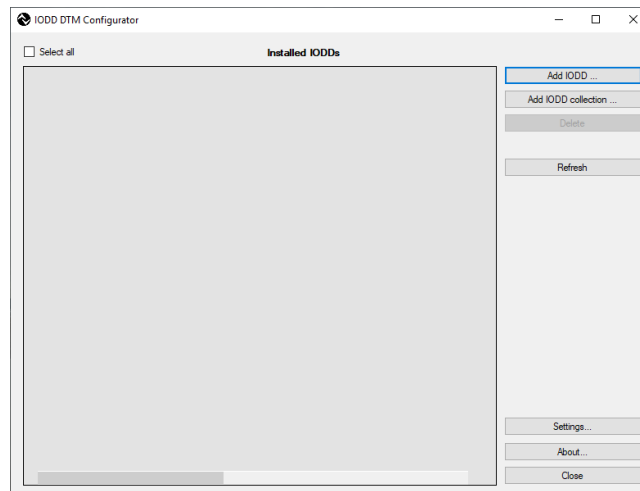

3. Browse to the IODD file (.xml) and select **Open**.
4. Start the configuration tool and update the device catalog.

Need help?

If the new DTM is not added automatically at start-up, then select **View** → **Device Catalog** → **Update Device Catalog**.

5.5 Perform the basic setup

5.5.1 Set the engineering units

Procedure

1. Under **Menu**, select **Parameter** → **Basic Setup**.
2. In the **Engineering Units** list, select **Metric** or **Imperial**.

Option	Description
Metric	Length: m Temperature: °C
Imperial	Length: in. Temperature: °F

3. Select **Write to device**.

5.5.2 Enter the reference height

Procedure

1. Under **Menu**, select **Parameter** → **Basic Setup**.
2. Enter the Reference Height.
3. Select **Write to device**.

Related information

[Reference height](#)

5.5.3 Configure the analog output

The transmitter can be set to output the level as a 4-20 mA signal.

Procedure

1. Under **Menu**, select **Parameter** → **Basic Setup**.
2. In the **OUT2 Configuration** list, select **Analog Output 4-20 mA**.
3. Select **OUT2** → **Analog Output 2**.
4. Enter the desired Upper Range Value (20 mA).
5. Enter the desired Lower Range Value (4 mA).
6. In the **Alarm Mode** list, select **Low Alarm** or **High Alarm**.
7. Select **Write to device**.

Related information

[Analog output](#)

5.5.4 Configure the digital output

The transmitter can be set to output a switching signal for high and low level limits (using the same pin).

Procedure

1. Under **Menu**, select **Parameter** → **Basic Setup**.
2. In the **OUT1 Configuration** or **OUT2 Configuration** list, select **Digital Output Normally Open**.
3. In the **Digital Outputs P-n** list, select **PnP** or **nPn**.
4. Select **Digital Output 1** or **Digital Output 2**.
5. Set the alarm parameters as desired.
6. Select **Write to device**.

Related information

[Digital output](#)

6 Operation and maintenance

6.1 Safety messages

Instructions and procedures in this section may require special precautions to ensure the safety of the personnel performing the operations. Information that potentially raises safety issues is indicated by a warning symbol () . Refer to the following safety messages before performing an operation preceded by this symbol.

WARNING

Failure to follow safe installation and servicing guidelines could result in death or serious injury.

Ensure the transmitter is installed by qualified personnel and in accordance with applicable code of practice.

Inspection and maintenance of this equipment shall be carried out by suitably trained personnel, in accordance with the applicable standards and code of practice.

Use the equipment only as specified in this manual. Failure to do so may impair the protection provided by the equipment.

Repair, e.g. substitution of components, etc. may jeopardize safety and is under no circumstances allowed.

WARNING

Process leaks could result in death or serious injury.

Handle the transmitter carefully.

Install and tighten process connectors before applying pressure.

Do not attempt to loosen or remove process connectors while the transmitter is in service.

6.2 View measurement data and events

The dashboard in Rosemount IO-Link Assistant displays the measured values, device status, switching status for digital output (on/off), and events. The measured values and switching states are visualized in a graph over a defined period of time.

Procedure

From the **Overview** screen, select **Dashboard**.



Figure 6-1: Dashboard

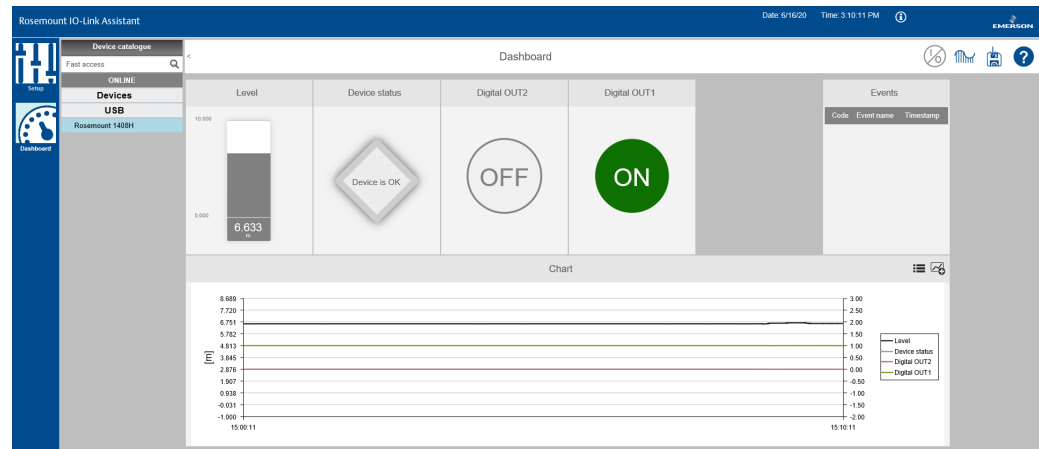

Need help?

Select the **Help** button for more information on the features and capabilities.

6.2.1 Measurement variables

Variable	Description
Level	The current level measurement value (from the zero level to the product surface).
Distance	The distance from the transmitter reference point to the surface.
Signal strength	The reflected signal strength from the surface.
Electronics temperature	The current temperature at the electronics.
Min electronics temperature	The measured minimum electronics temperature.
Max electronics temperature	The measured maximum electronics temperature.

6.2.2 Interpret measurement status

A “Good” or “Bad” status next to a value is an indication of the reliability or integrity of the data being received, not an indication of whether or not the value is within the configured upper or lower ranges. A value that triggers an alert, such as a high or low temperature indication, will change the overall status of the device, but the measurement might still be indicated as “Good” if the reliability of the data is good.

6.3 Enter the demonstration mode

In this mode, the signal processing method is optimized for demo situations when simulating a product surface with, for example, a measurement target plate.

Note

This mode is intended for demonstration purposes only, and should not be used for normal operations.

Prerequisites

The demonstration mode will reset the following parameters to factory settings:

- Measurement recovery time
- Negative level
- Damping value

When returning to Default Mode, you will therefore need to reconfigure these parameters (if desired).

Procedure

1. Under **Menu**, select **Parameter** → **Service Tools** → **Application Mode**.
2. Select **Enter Demonstration Mode**.

Postrequisites

1. Select **Exit Demonstration Mode** to return to normal operation (Default Mode).
2. Verify that the **Application Mode** is set to **Default Mode**.

6.4 Replacing the O-ring

The process wetted O-ring should be checked periodically. Replace with O-ring designed for Rosemount 1408H if there are any signs of damage.

Procedure

1. Secure the transmitter and adapter using a vise.

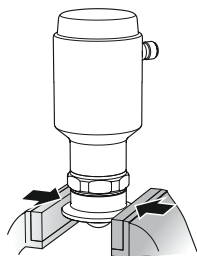

2. Unscrew the adapter from the transmitter.

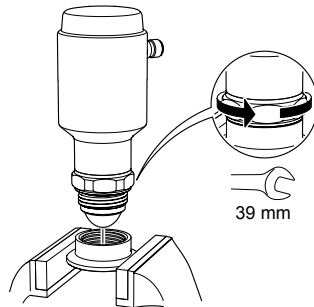

3. Remove the O-ring using a suitable non-metallic tool.

Note

Be careful not to scratch any of the surfaces.

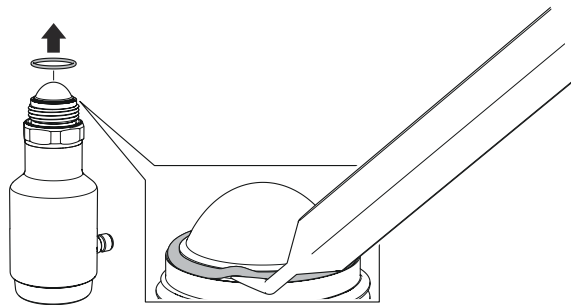

4. If needed, clean the sealing areas.

Related information

[Install the adapter](#)

7 Service and troubleshooting

7.1 Safety messages

Instructions and procedures in this section may require special precautions to ensure the safety of the personnel performing the operations. Information that potentially raises safety issues is indicated by a warning symbol (⚠). Refer to the following safety messages before performing an operation preceded by this symbol.

⚠ WARNING

Failure to follow safe installation and servicing guidelines could result in death or serious injury.

Ensure the transmitter is installed by qualified personnel and in accordance with applicable code of practice.

Inspection and maintenance of this equipment shall be carried out by suitably trained personnel, in accordance with the applicable standards and code of practice.

Use the equipment only as specified in this manual. Failure to do so may impair the protection provided by the equipment.

Repair, e.g. substitution of components, etc. may jeopardize safety and is under no circumstances allowed.

⚠ WARNING

Process leaks could result in death or serious injury.

Handle the transmitter carefully.

Install and tighten process connectors before applying pressure.

Do not attempt to loosen or remove process connectors while the transmitter is in service.

7.2 Diagnostic messages

7.2.1 Device hardware fault – Device exchange

Alarm classification

Device status	Failure
Class	Error

Possible cause

An electronics error has occurred.

Recommended actions

1. Restart the device.
2. If the condition persists, replace the device.

Related information

[Perform a device reset](#)

7.2.2 Device software fault – Check firmware revision

Alarm classification

Device status	Failure
Class	Error

Possible cause

The software has detected an internal error.

Recommended actions

1. Restart the device.
2. Restore default settings and reconfigure the device.
3. If the condition persists, replace the device.

Related information

[Perform a device reset](#)

[Restore to factory settings](#)

7.2.3 General power supply fault – Check availability

Alarm classification

Device status	Failure
Class	Error

Possible cause

Power supply drops below 18 Vdc during transmitter start-up.

Recommended actions

Verify voltage is 18-30 Vdc at the transmitter terminal.

7.2.4 Parameter error – Check data sheet and values

Alarm classification

Device status	Failure
Class	Error

Possible cause

The device has detected a configuration error.

Recommended actions

1. If analog output is used, check Upper and Lower Range Values.
2. If digital output is used, check High and Low Alarm Set Points.
3. If condition persists, restore default settings and reconfigure the device.

Related information

[Upper/lower range value](#)

[Alarm set points](#)

[Restore to factory settings](#)

7.2.5 Device memory failure – Restore default settings

Alarm classification

Device status	Failure
Class	Error

Possible cause

Configuration data has been corrupted, for example, due to a power loss during writing.

Recommended actions

1. Restore default settings, restart device, and reconfigure the device.
2. If the condition persists, replace the device.

Related information

[Restore to factory settings](#)
[Perform a device reset](#)

7.2.6 Simulation active – Check operational mode

Alarm classification

Device status	Functional check
Class	Warning

Possible cause

The device is in simulation mode and is not reporting actual information.

Recommended actions

1. If this behavior is not desired, stop simulation mode.
2. If the condition persists, restart the device.

Related information

[Use the simulation mode](#)
[Perform a device reset](#)

7.2.7 Level measurement lost – Check application

Alarm classification

Device status	Failure
Class	Error

Possible cause

No valid level reading. Reasons may be multiple:

- No valid surface echo peak in the measuring range
- Incorrect device configuration

Recommended actions

1. Analyze the Echo Peaks and check device configuration, especially General Threshold.
2. Check device physical installation (for instance antenna contamination).
3. Consider increasing Measurement Recovery Time parameter for intermittent conditions.
4. Restore default settings, restart device, and reconfigure the device.
5. If the condition persists, replace the device.

Related information

[Analyze the echo peaks](#)
[Adjust the general threshold](#)
[Measurement recovery time](#)
[Restore to factory settings](#)
[Perform a device reset](#)

7.2.8 Device temperature over-run – Clear source of heat

Alarm classification

Device status Out of specification

Class Warning

Possible cause

The electronics temperature is outside the operating range.

Recommended actions

1. Verify ambient temperature is within the operating range.
2. Clear source of heat.

Related information

[Ambient temperature](#)

7.2.9 Device temperature under-run – Insulate device

Alarm classification

Device status Out of specification

Class Warning

Possible cause

The electronics temperature is outside the operating range.

Recommended actions

1. Verify ambient temperature is within the operating range.
2. Insulate device.

Related information

[Ambient temperature](#)

7.2.10 Short circuit – Check installation

Alarm classification

Device status Out of Specification

Class Error

Possible cause

Short circuit on the digital output.

Recommended actions

Check cable and connections.

7.2.11 Primary supply voltage over-run – Check tolerance

Alarm classification

Device status Out of specification

Class Warning

Possible cause

Supply voltage is too high.

Recommended actions

Verify voltage is 18-30 Vdc at the transmitter terminal.

7.2.12 Primary supply voltage under-run – Check tolerance

Alarm classification

Device status Out of specification

Class Warning

Possible cause

Supply voltage is too low.

Recommended actions

Verify voltage is 18-30 Vdc at the transmitter terminal.

7.2.13 Maintenance required - Cleaning

Alarm classification

Device status	Maintenance required
Class	Notification

Possible cause

Product build-up on the antenna.

Recommended actions

Clean the antenna.

Use a damp cloth and a mild cleaning agent suitable for the media and wetted parts of the transmitter.

Note

Take care not to scratch the PTFE sealing surfaces.

Related information

[Material exposed to tank atmosphere](#)
[Components of the transmitter](#)

7.2.14 Max EEPROM write cycles expired – Check master and restart the device

Alarm classification

Device status	Maintenance required
Class	Warning

Possible cause

Frequent writing of parameters from master to device.

Recommended actions

1. Check the master configuration.
2. Restart the device.
3. If error persists, contact your local Emerson representative.

Related information

[Perform a device reset](#)

7.3 Troubleshooting incorrect level readings

7.3.1 Reported level is too high or low

Figure 7-1: Symptom

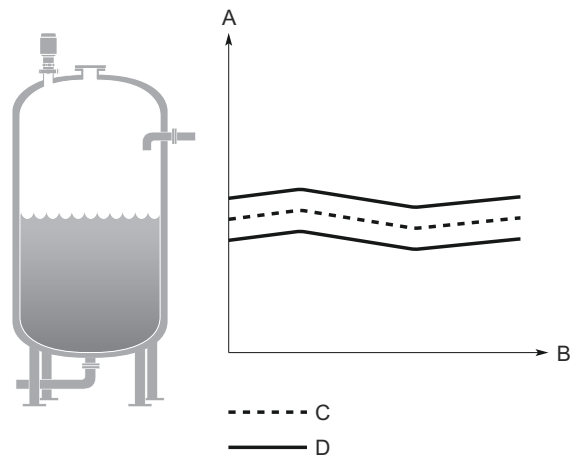

- A. Level
- B. Time
- C. Actual level
- D. Reported level

Possible cause

Incorrect tank geometry configuration.

Recommended actions

- Verify the tank geometry parameters are configured correctly (especially the Reference Height).
- Analyze the Echo Peaks and check General Threshold.
- Restore default settings and reconfigure the device.

Related information

[Reference height](#)

[Analyze the echo peaks](#)

[Adjust the general threshold](#)

[Restore to factory settings](#)

7.3.2 Level is stuck in measuring range

Figure 7-2: Symptom

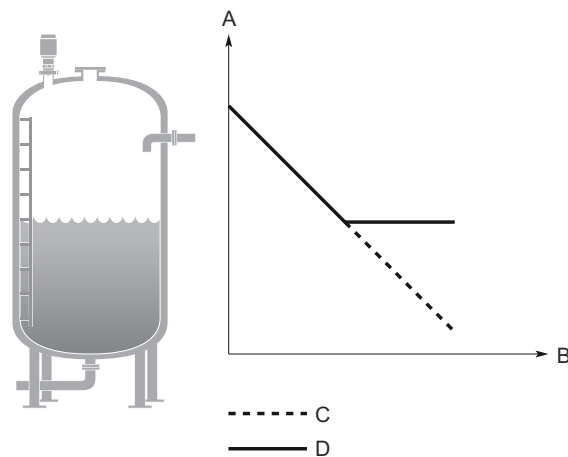

- A. Level
- B. Time
- C. Actual level
- D. Reported level

Possible cause

Disturbing object in the tank.

Recommended actions

- Analyze the Echo Peaks and check General Threshold.
- Remove the disturbing object.
- Rotate the transmitter in steps of about 15 degrees. After each step, check if impact of disturbing echoes is decreased by analyzing the Echo Peaks.



- Put an inclined metal plate on top of the disturbing object.
- Move the transmitter to another position.

Related information

[Analyze the echo peaks](#)

[Adjust the general threshold](#)

[Mounting position](#)

7.3.3 Level is stuck in full tank

Figure 7-3: Symptom

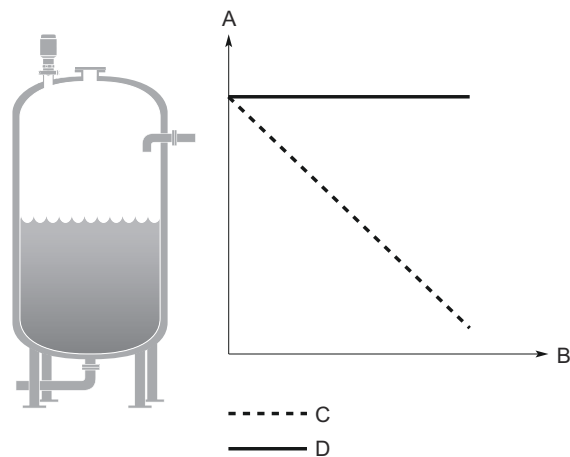

- A. Level
- B. Time
- C. Actual level
- D. Reported level

Possible cause

Disturbing object near the antenna.

Recommended actions

- Analyze the Echo Peaks and check General Threshold.
- Increase the Upper Null Zone.
- Remove the disturbing object.
- Move the transmitter to another position.

Possible cause

Product build-up on the antenna.

Recommended actions

- Clean the antenna.

Related information

[Analyze the echo peaks](#)
[Adjust the general threshold](#)
[Change the upper null zone](#)
[Mounting position](#)

7.3.4 Level value drops when close to antenna

Level value drops to a lower value when product surface is close to antenna.

Figure 7-4: Symptom

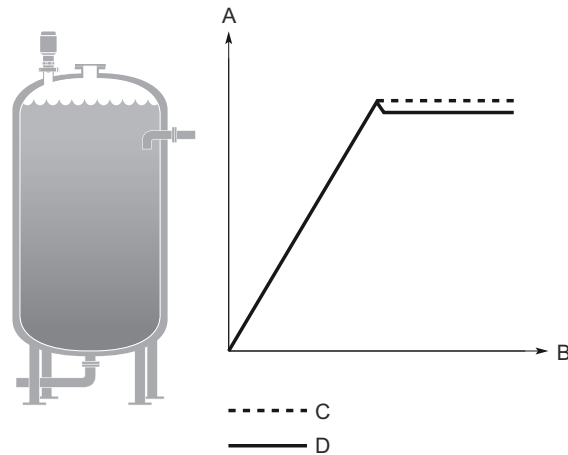

- A. Level
- B. Time
- C. Actual level
- D. Reported level

Possible cause

Product surface is within the Upper Null Zone and a disturbance echo is interpreted as the product surface.

Recommended actions

- Check the setting of the Upper Null Zone.

Related information

[Change the upper null zone](#)

7.3.5 Measured level fluctuates

Figure 7-5: Symptom

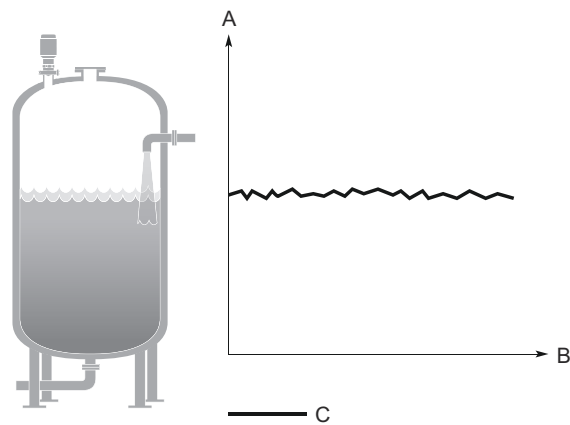

- A. Level
- B. Time
- C. Reported level

Possible cause

Excessive foaming or turbulence.

Recommended actions

- Under turbulent conditions with low level rates, consider increasing the Damping value.

Related information

[Damping value](#)

7.3.6 Measured level is occasionally unstable

Figure 7-6: Symptom

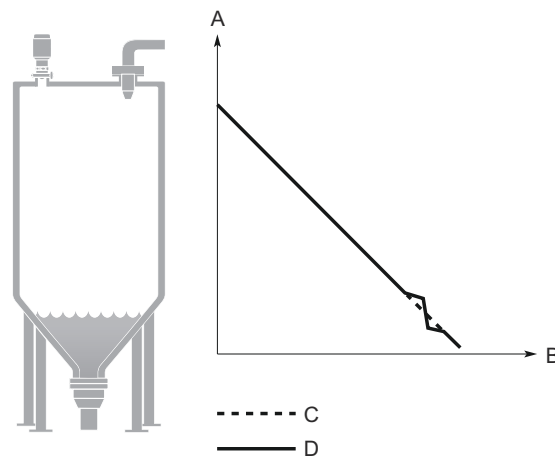

- A. Level
- B. Time
- C. Actual level
- D. Reported level

Possible cause

The product surface is close to a suppressed false echo.

Recommended actions

- If possible, remove the disturbing object.

Related information

[Analyze the echo peaks](#)

7.3.7 Lagging of measured level

Symptom

Measured level lags during rapid level changes.

Figure 7-7: Symptom

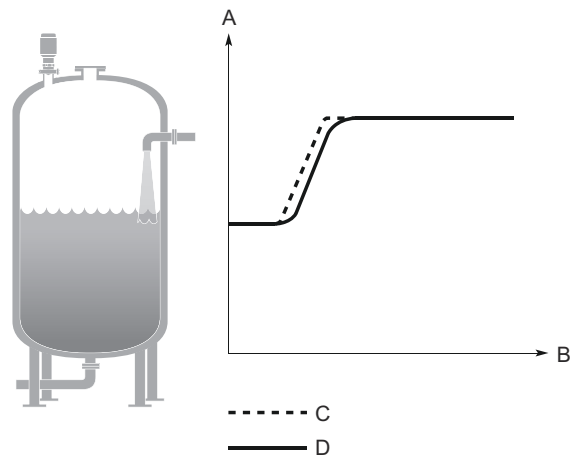

- A. Level
- B. Time
- C. Actual level
- D. Reported level

Possible cause

Damping value is set too high.

Recommended actions

- If there is a problem with lag during rapid level changes, consider decreasing the Damping value.

Related information

[Damping value](#)

7.3.8 Incorrect level at 100% (20 mA)

Symptom

Measured level is correct at 0% (4 mA) but incorrect at 100% (20 mA).

Figure 7-8: Symptom

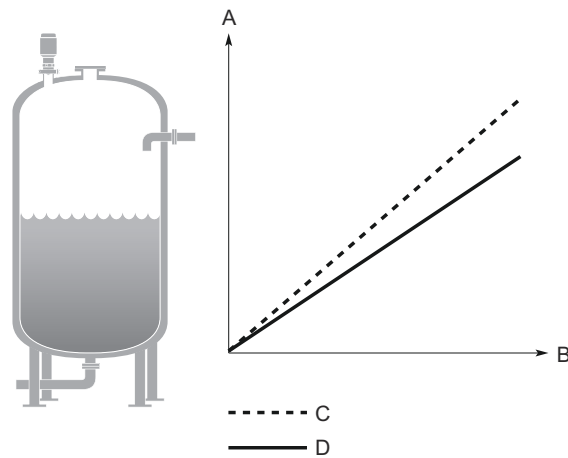

- A. Level
- B. Time
- C. Actual level
- D. Reported level

Possible cause

Upper Range Value is not set correctly.

Recommended actions

- Check that the Upper Range Value matches the 100% (20 mA) level in the tank.

Related information

[Upper/lower range value](#)

7.3.9 Incorrect level when product surface is above 50%

Symptom

The reported level is incorrect when the product surface is above the 50% level.

Figure 7-9: Symptom

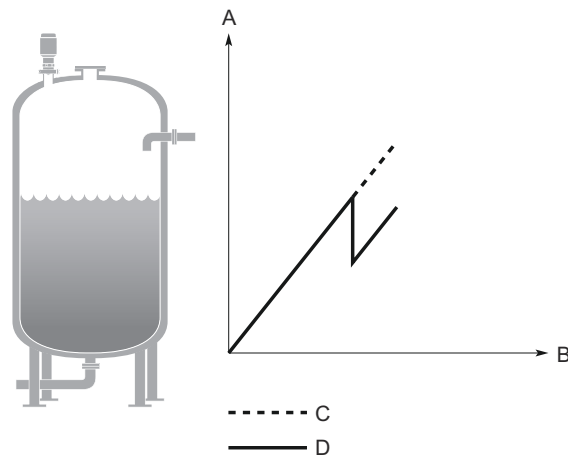

- A. Level
- B. Time
- C. Actual level
- D. Reported level

Possible cause

A strong double bounce echo is interpreted as the product surface.

Recommended actions

- Move the transmitter to another position.

Related information

[Mounting position](#)

7.3.10 Dropping of level close to tank bottom

Symptom

Measured value drops to zero level in the tank bottom region.

Figure 7-10: Symptom

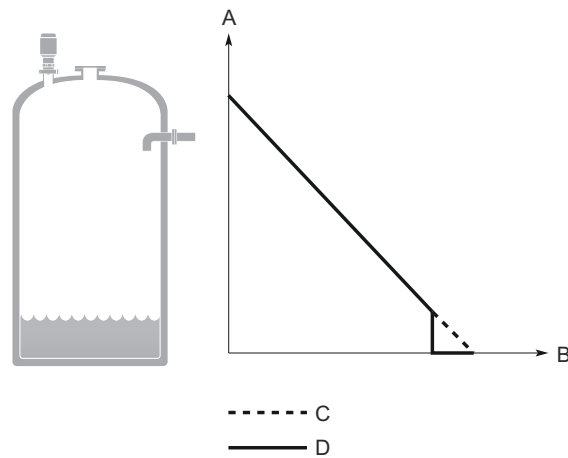

- A. Level
- B. Time
- C. Actual level
- D. Reported level

Possible cause

Transmitter has locked on a strong tank bottom echo.

Recommended actions

- Verify the Reference Height is configured correctly.

Related information

[Reference height](#)

7.3.11 Level measurement is lost in an empty tank

The transmitter reports "Level measurement lost" in an empty tank after closing the side manway door.

Figure 7-11: Symptom

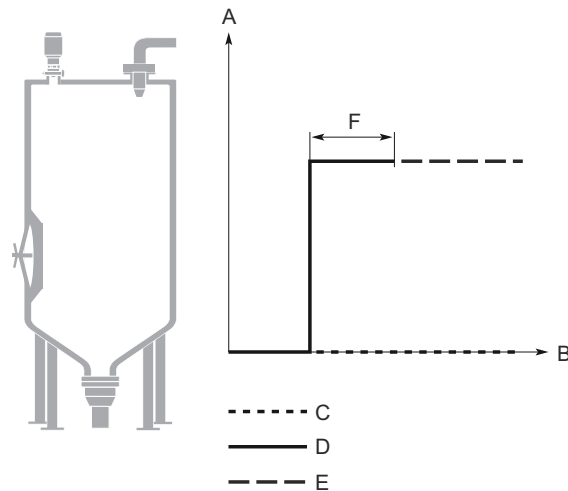

- A. Level
- B. Time
- C. Actual level
- D. Reported level
- E. Level measurement lost
- F. Manway door open

Possible cause

When the manway door is opened inward, it generates a disturbance echo which is interpreted as the product surface echo. After closing the door, the echo is lost and the transmitter reports "Level measurement lost". The message is cleared when start filling the tank.

Recommended actions

- Before opening the manway door, disconnect power to the transmitter.
- After closing, restart the device.
- Move the transmitter to another position.

Related information

[Mounting position](#)

[Perform a device reset](#)

7.3.12 Alarm mode close to tank bottom

Symptom

When the product surface is near the sloped tank bottom, the transmitter enters alarm mode.

Figure 7-12: Symptom

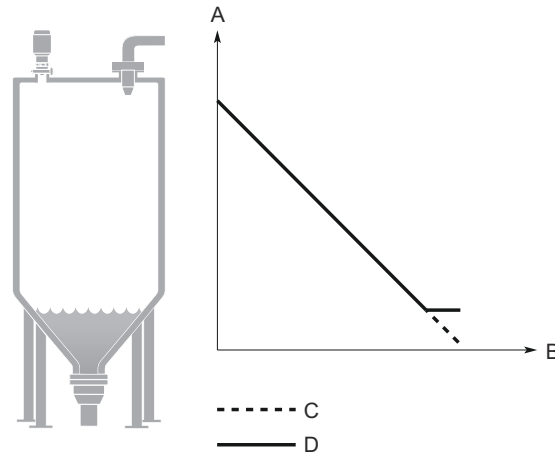

- A. Level
- B. Time
- C. Actual level
- D. Reported level

Possible cause

Reduction of projected surface area close to sloping tank bottom.

Recommended actions

- Verify the tank geometry parameters are configured correctly (especially the Reference Height and Bottom Offset).

Related information

[Reference height](#)

[Bottom offset](#)

7.4 Managing disturbance echoes

There are two general methods for managing disturbance echoes:

- Set general threshold to filter out weak disturbance echoes and noise.
- Increase the Upper Null Zone to block out disturbance echoes at the top of the tank.

7.4.1 Adjust the general threshold

If necessary, the general threshold value can be increased if a disturbance echo is interpreted as the product surface. Alternatively, a lower threshold may be required to handle weak surface echoes (e.g. due to excessive foaming or turbulence).

Prerequisites

The general threshold is set at factory for optimum performance and should not normally need an adjustment.

Before changing the factory default value, study the position and amplitude of the different echo peaks.

Procedure

1. Under **Menu**, select **Parameter** → **Advanced Setup**.
2. In the **General Threshold** box, enter the desired value.
3. Select **Write to device**.

Related information

[Analyze the echo peaks](#)
[General threshold](#)

7.4.2 Change the upper null zone

The Upper Null Zone defines a zone close to the transmitter where echoes are ignored. This zone can be extended to block out disturbing echoes at the top of the tank.

Prerequisites

Note

Make sure the Upper Range Value (100%/20 mA) value is below the Upper Null Zone. Measurements are not performed within the Upper Null Zone.

Procedure

1. Identify desired Upper Null Zone by analyzing the echo peaks.
 - a) Under **Menu**, select **Diagnosis** → **Echo Peaks**.
 - b) View the echo peaks to find out if there are disturbing echoes close to tank top.
2. Set the desired Upper Null Zone value.
 - a) Under **Menu**, select **Parameter** → **Geometry** → **Advanced**.
 - b) Enter the desired Upper Null Zone value.
 - c) Select **Write to device**.

Figure 7-13: Upper Null Zone

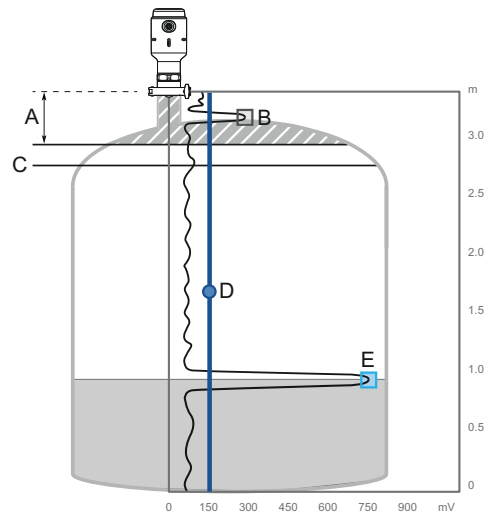

- A. Upper Null Zone
- B. Disturbance echo
- C. 100% (20 mA)
- D. General threshold
- E. Product surface echo

Related information

[Upper null zone](#)

7.5 Service and troubleshooting tools

7.5.1 Analyze the echo peaks

Measurement problems can be understood by studying the position and amplitude of the different peaks.

Procedure

Under **Menu**, select **Diagnosis** → **Echo Peaks**.

Echo peaks

See [Table 7-1](#) for a list of possible echo peaks.

Table 7-1: Echo Peak Types

Type	Description
Surface	Echo tracked as the current surface echo
Unknown	Echo identified as unknown (can be a surface candidate)
Suppressed	Echoes that are identified but suppressed by the device
Tank bottom echo	Echo considered as an echo from the tank bottom

7.5.2 Perform a device reset

The function is used to reset/restart the electronics without re-cycling the power.

Procedure

1. Under **Menu**, select **Parameter** → **Service Tools** → **Maintenance**.
2. Select **Device Reset**.

7.5.3 Restore to factory settings

This function restores the transmitter to factory settings (user configuration is overwritten).

Procedure

1. Under **Menu**, select **Parameter** → **Service Tools** → **Maintenance**.
2. Select **Restore Factory Settings**.

7.5.4 Use the simulation mode

It is possible to set the level to a simulated value for testing purposes. The simulated value affects both digital and analog output.

Procedure

1. Under **Menu**, select **Parameter** → **Service Tools** → **Simulation**.
2. In the **Simulated Level** box, enter the desired value.
3. Select **Write to device**.
4. Select **Start simulation (60 min)**.

7.5.5 Calibrate analog out

Use this function to calibrate the analog output by comparing the actual output current with the nominal 4 mA and 20 mA currents. Calibration is done at factory and the analog output does not normally need to be recalibrated.

Prerequisites

Connect a calibrated ampere meter to the analog output loop.

Procedure

1. Under **Menu**, select **Parameter** → **Service Tools** → **Analog Out Calibration**.
2. Perform the calibration of 4 mA.
 - a) Select **Enter 4 mA Fixed Current Mode** to set the analog out to 4 mA.
 - b) Measure the analog output with the ampere meter.
 - c) In the **4 mA Measured Current** box, enter the measured current.
 - d) Select **Write to device**.
 - e) Select **Calibrate 4 mA**.
 - f) Measure the analog output with the ampere meter and verify it is within 4 ± 0.01 mA.
3. Perform the calibration of 20 mA.
 - a) Select **Enter 20 mA Fixed Current Mode** to set the analog out to 20 mA.
 - b) Measure the analog output with the ampere meter.
 - c) In the **20 mA Measured Current** box, enter the measured current.
 - d) Select **Write to device**.
 - e) Select **Calibrate 20 mA**.
 - f) Measure the analog output with the ampere meter and verify it is within 20 ± 0.01 mA.
4. Select **Exit Fixed Current Mode**.

7.5.6 View input registers

Measured data is continuously stored in the input registers. By viewing the contents of the input registers, expert users can check that the transmitter works properly.

Procedure

1. Under **Menu**, select **Diagnosis** → **Read Input Registers**.
2. In the **Input Reg. Number** box, enter the input register to start reading from.
The default start register is 5100 (Alert Summary).
3. Select **Write to device**.

4. Select **Read to device** (not required in Rosemount IO-Link Assistant).
Five registers will be read, starting from the selected number.

7.5.7 View holding registers

The holding registers store various transmitter parameters, such as configuration data, used to control the measurement performance.

Procedure

1. Under **Menu**, select **Diagnosis** → **Read Holding Registers**.
2. In the **Holding Reg. Number** box, enter the holding register to start reading from.
3. Select **Write to device**.
4. Select **Read to device** (not required in Rosemount IO-Link Assistant).
Five registers will be read, starting from the selected number.

7.5.8 Edit holding registers

The holding registers store various transmitter parameters, such as configuration data, used to control the measurement performance.

Prerequisites

Note

Do not use holding registers to configure the transmitter unless you are qualified. This dialog is mainly used for service purposes and for advanced configuration.

Procedure

1. Unlock the write protection of the holding registers.
 - a) Under **Menu**, select **Diagnosis** → **Write Holding Registers** → **Write Holding Registers (Word)**.
 - b) In the **Register Number** box, enter 0.
 - c) In the **Value (Word)** box, enter 1234.
 - d) Select **Write to device**.
2. To edit a holding register value:
 - a) Under **Write Holding Registers (Float)** or **Write Holding Registers (Word)**, enter the register number and the corresponding value.
 - b) Select **Write different values to device (Write to device in Rosemount IO-Link Assistant)**.
3. Verify the written value by reading the holding register number.
4. Perform a device reset to write protect the holding registers.

Related information

[Perform a device reset](#)

7.6 Service support

To expedite the return process outside of the United States, contact the nearest Emerson representative.

Within the United States, call the Emerson Instrument and Valve Response Center using the 1-800-654-RSMT (7768) toll-free number. This center, available 24 hours a day, will assist you with any needed information or materials.

The center will ask for product model and serial numbers, and will provide a Return Material Authorization (RMA) number. The center will also ask for the process material to which the product was last exposed.

⚠ CAUTION

Individuals who handle products exposed to a hazardous substance can avoid injury if they are informed of and understand the hazard. Returned products must include a copy of the required Safety Data Sheet (SDS) for each substance.

Emerson Instrument and Valve Response Center representatives will explain the additional information and procedures necessary to return goods exposed to hazardous substances.

A Specifications and reference data

A.1 Performance specifications

A.1.1 General

Reference conditions

- Measurement target: Stationary metal plate, no disturbing objects
- Temperature: 59 to 77 °F (15 to 25 °C)
- Ambient pressure: 14 to 15 psi (960 to 1060 mbar)
- Relative humidity: 25-75%
- Damping: Default value, 2 s

Instrument accuracy (under reference conditions)

±0.08 in. (±2 mm)⁽¹⁾

Repeatability

±0.04 in. (±1 mm)

Ambient temperature effect

±0.04 in. (±1 mm)/10 K

Sensor update rate

Minimum 1 update per second (typically 5 updates per second)

Maximum level rate

200 mm/s

A.1.2 Measuring range

Maximum measuring range

33 ft. (10 m)⁽²⁾

(1) Refers to inaccuracy according to IEC 60770-1 when excluding installation dependent offset. See the IEC 60770-1 standard for a definition of radar specific performance parameters and if applicable corresponding test procedures.

(2) Note that a combination of adverse process conditions, such as heavy turbulence, foam, and condensation, together with products with poor reflection may affect the measuring range.

Accuracy over measuring range

Figure A-1 illustrates the accuracy over measuring range at reference conditions.

Figure A-1: Accuracy Over Measuring Range

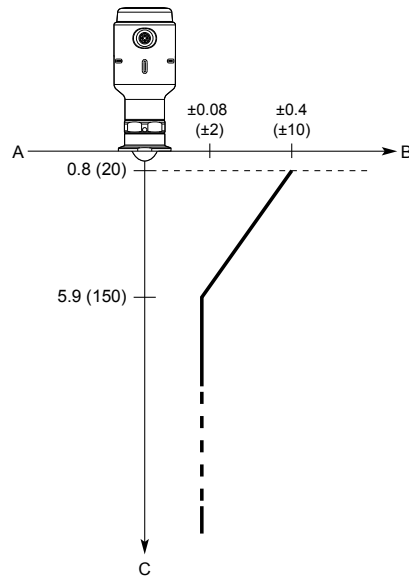

- A. Device Reference Point
- B. Accuracy in inches (millimeters)
- C. Distance in inches (millimeters)

A.1.3 Environment

Vibration resistance

- 2 g at 10-1000 Hz according to IEC 61298-3, level “field with general application”

Electromagnetic compatibility (EMC)

- EMC Directive (2014/30/EU): EN 61326-1
- NAMUR recommendations NE21 (only 4-20 mA output)

Pressure Equipment Directive (PED)

Complies with 2014/68/EU article 4.3

Radio approvals

- Radio Equipment Directive (2014/53/EU): ETSI EN 302 372 and EN 62311
- Part 15 of the FCC Rules
- Industry Canada RSS 211

Related information

[Product certifications](#)

A.2 Functional specifications

A.2.1 General

Field of application

Continuous level measurements in the hygienic industry.

Minimum dielectric constant

2

Measurement principle

Frequency Modulated Continuous Wave (FMCW)

Frequency range

77 to 81 GHz

Maximum output power

3 dBm (2 mW)

Internal power consumption

< 2 W (normal operation at 24 Vdc, no outputs)

< 3.6 W (normal operation at 24 Vdc, digital and analog outputs active)

Humidity

0 - 100% relative humidity, non-condensing

Turn-on time

< 15 s⁽³⁾

A.2.2 Outputs

The transmitter provides two configurable outputs:

Output 1 Digital output / IO-Link mode

Output 2 Digital output or active 4-20 mA analog output

(3) Time from when power is applied to the transmitter until performance is within specifications.

A.2.3 Digital output

Switching signal for high and low level limits (using the same pin)

Output type

PNP/NPN configurable

Switching function

Normally open

Permanent current rating

< 50 mA

Maximum voltage drop

2.5 V

A.2.4 4-20 mA analog output

Load limitations

Maximum loop resistance is determined by the voltage level of the external power supply:

$$\text{Maximum Loop Resistance} = 43.5 \times (\text{External Power Supply Voltage} - 18) + 600 \Omega$$

Figure A-2: Load Limits

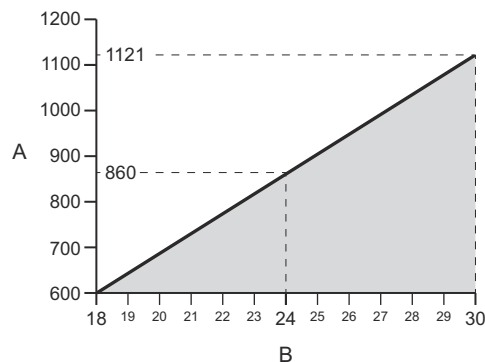

A. Loop Resistance (Ω)

B. External Power Supply Voltage (Vdc)

Analog signal on alarm

The transmitter automatically and continuously performs self-diagnostic routines. If a failure or a measurement error is detected, the analog signal will be driven offscale to alert the user. High or low failure mode is user-configurable.

Table A-1: Signal on Alarm

Level	Custom levels	NAMUR NE43 (default)
Low	3.5 to 4.0 mA	3.5 mA (NAMUR \leq 3.6 mA)
High	20.0 to 22.5 mA	21.5 mA (NAMUR \geq 21.0 mA)

Analog saturation levels

The transmitter will continue to set a current that corresponds to the measurement until reaching the associated saturation limit (and then freeze).

Table A-2: Saturation Levels

Level	Custom levels	NAMUR NE43 (default)
Low	3.5 to 4.0 mA	3.8 mA
High	20.0 to 22.5 mA	20.5 mA

A.2.5 IO-Link specifications

IO-Link revision

1.1

Transfer type

COM2 (38.4 kBaud)

SIO mode

Yes

IO-Link master port

Class A

Minimum cycle time

6 ms

A.2.6 Configuration

IO-Link configuration tools

Examples:

- Rosemount IO-Link Assistant (available as accessory)
- FDT® frame applications, e.g. PACTware

Damping

User selectable (default is 2 s, minimum is 0 s)

Output units

- Level: in., m
- Temperature: °F, °C
- Signal strength: mV

Output variables

Variable	4-20 mA	DO1 and DO2	Digital, service tools using IODD	IO-Link PDIn (to the PLC)
Level	✓	✓	✓	✓
Distance (ullage)	N/A	N/A	✓	N/A
Electronics temperature	N/A	N/A	✓	N/A
Signal strength	N/A	N/A	✓	N/A

A.2.7 Process pressure

-15 to 116 psig (-1 to 8 bar)

Atmospheric pressure at temperatures below -4 °F (-20 °C)

A.2.8 Temperature limits

Process temperature

With adapter

-4 to 302 °F (-20 to 150 °C)

Without adapter

-40 to 302 °F (-40 to 150 °C)

Ambient temperature

-40 to 176 °F (-40 to 80 °C)

The ambient temperature limits may be further restricted by the process temperature as described by [Figure A-3](#).

Figure A-3: Ambient Temperature vs. Process Temperature

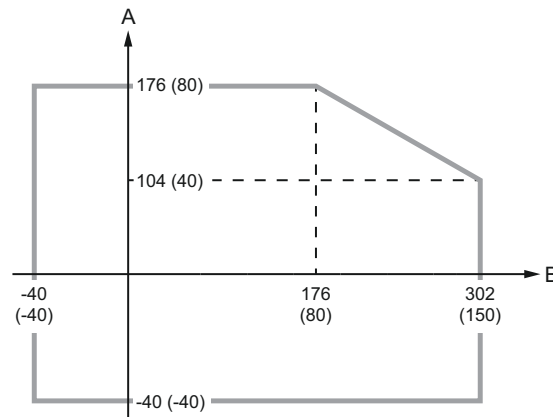

A. Ambient temperature °F (°C)

B. Process temperature °F (°C)

Storage temperature

-40 °F to 194 °F (-40 °C to 90 °C)

A.3 Physical specifications

A.3.1 Material selection

Emerson provides a variety of Rosemount products with various product options and configurations including materials of construction that can be expected to perform well in a wide range of applications. The Rosemount product information presented is intended as a guide for the purchaser to make an appropriate selection for the application. It is the purchaser's sole responsibility to make a careful analysis of all process parameters (such as all chemical components, temperature, pressure, flow rate, abrasives, contaminants, etc.), when specifying product, materials, options, and components for the particular application. Emerson is not in a position to evaluate or guarantee the compatibility of the process fluid or other process parameters with the product, options, configuration or materials of construction selected.

A.3.2 Transmissible Spongiform Encephalopathy (TSE) declaration

This declaration is applicable to the Rosemount 1408H when fitted with the hygienic adapter and O-ring.

Emerson certifies no process wetted components used in this product contain substances of animal origin. Materials used in the production or processing of wetted components for this product meet the requirements stated in EMA/410/01 Rev. 3 and ISO 22442-1:2015. Wetted components in this product are considered free of TSE.

Related information

[Materials of construction](#)

A.3.3 Food and Drug Administration (FDA) declaration

When fitted with the hygienic adapter and O-ring, the process wetted components used in this product conform to FDA 21CFR110, Subpart C: Food and Drug Administration - Current Good Manufacturing Practice In Manufacturing, Packing, Or Holding Human Food.

Related information

[Materials of construction](#)

A.3.4 Housing and enclosure

Materials

Polished stainless steel 316L (EN 1.4404)

Transmitter weight

1.1 lb (0.5 kg)⁽⁴⁾

Ingress protection

- IP66/68⁽⁵⁾/69 (IEC 60529)
- IP6K9K (ISO 20563:2013)
- NEMA[®] 4X

The stated ingress protection only applies when plugged in using a suitable M12 connector that has the appropriate ingress protection.

⁽⁴⁾ Adapter not included.

⁽⁵⁾ IP68 at 9.8 ft. (3 m) for more than 30 minutes.

A.3.5 Surface finishes

Process wetted parts

- $R_a < 30 \mu\text{-in.}$ ($0.76 \mu\text{-m}$) for polymeric parts
- $R_a < 16 \mu\text{-in.}$ ($0.4 \mu\text{-m}$) for metallic parts

Non-wetted parts

- $R_a < 30 \mu\text{-in.}$ ($0.76 \mu\text{-m}$) for stainless steel housing

A.3.6 Process connection

ISO 228/1-G1 thread with a wide choice of hygienic adapters

A.3.7 Material exposed to tank atmosphere

With adapter

- PTFE sealing: PTFE fluoropolymer
- Adapter: 316L (EN 1.4435)
- Hygienic O-ring: EPDM or FKM

Without adapter

- PTFE sealing: PTFE fluoropolymer
- O-ring: FVMQ
- G1 thread: 316L (EN 1.4404)
- Profile ring: FKM

A.4 Dimensional drawings

Figure A-4: Rosemount 1408H

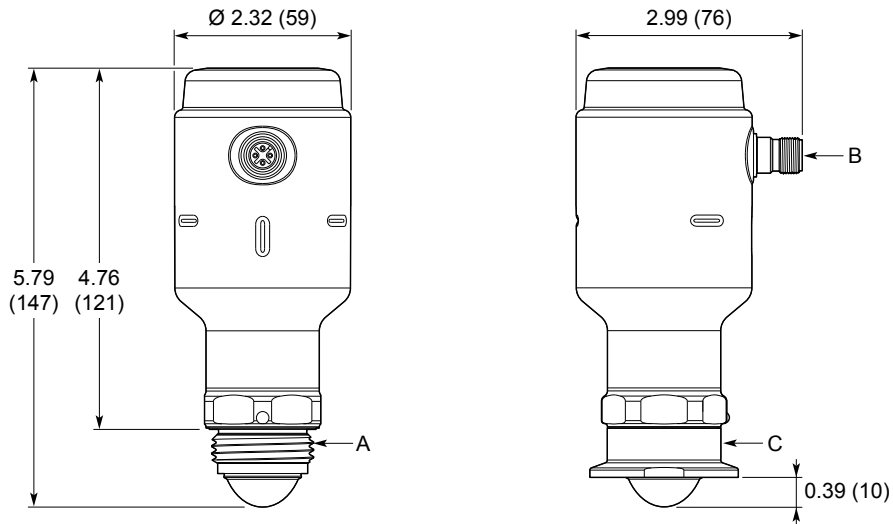

- A. ISO 228/1-G1 thread
- B. M12 connector (A-coded)
- C. Hygienic process connection adapter

Dimensions are in inches (millimeters).

See also the Rosemount Hygienic Process Connection Adapters [Type 1 Drawing](#).

B Product certifications

Rev 1.2

B.1 European directive information

A copy of the EU Declaration of Conformity can be found at the end of the Quick Start Guide. The most recent revision of the EU Declaration of Conformity can be found at [Emerson.com/Rosemount](https://emerson.com/Rosemount).

B.2 UK regulation information

A copy of the UKCA Declaration of Conformity can be found at the end of the Quick Start Guide. The most recent revision of the UKCA Declaration of Conformity can be found at [Emerson.com/Rosemount](https://emerson.com/Rosemount).

B.3 Ordinary location certification

As standard, the transmitter has been examined and tested to determine that the design meets the basic electrical, mechanical, and fire protection requirements by a nationally recognized test laboratory (NRTL) as accredited by the Federal Occupational Safety and Health Administration (OSHA).

Certificate	80031621
Standards	CAN/CSA-C22.2 No. 61010-1-12, UL Std. No. 61010-1
Markings	18-30 VDC, 3.6W

The device may only be powered by a power supply unit with a limited energy electric circuit max. 30 Vdc output in accordance with CAN/CSA-C22.2 No. 61010-1-12 / UL Std. No. 61010-1 (3rd Edition) chapter 6.3.1/6.3.2 and 9.4 or class 2 according to CSA 223/UL 1310.

B.4 Telecommunication compliance

Measurement principle

Frequency Modulated Continuous Wave (FMCW), 80 GHz

Maximum output power

3 dBm (2 mW)

Frequency range

77 to 81 GHz

TLPR (Tank Level Probing Radar)

TLPR (Tank Level Probing Radar) equipment are devices for measurement of level in a closed space only (i.e metallic or reinforced concrete or fiberglass tanks, or similar enclosure structures made of comparable attenuating material). Rosemount 1408H is TLPR device. Hardware Version Identification Number (HVIN) is 1408T.

B.5 FCC

Note: This equipment has been tested and found to comply with the limits for a Class B digital device, pursuant to part 15 of the FCC Rules. These limits are designed to provide reasonable protection against harmful interference in a residential installation. This equipment generates, uses and can radiate radio frequency energy and, if not installed and used in accordance with the instructions, may cause harmful interference to radio communications. However, there is no guarantee that interference will not occur in a particular installation. If this equipment does cause harmful interference to radio or television reception, which can be determined by turning the equipment off and on, the user is encouraged to try to correct the interference by one or more of the following measures:

- Reorient or relocate the receiving antenna.
- Increase the separation between the equipment and receiver.
- Connect the equipment into an outlet on a circuit different from that to which the receiver is connected.
- Consult the dealer or an experienced radio/TV technician for help.

FCC ID K8C1408T

B.6 IC

This device complies with Industry Canada's licence-exempt RSS standard. Operation is subject to the following conditions:

1. This device may not cause harmful interference.
2. This device must accept any interference received, including interference that may cause undesired operation.
3. The installation of the TLPR device shall be done by trained installers in strict compliance with the manufacturer's instructions.
4. The use of this device is on a "no-interference, no-protection" basis. That is, the user shall accept operations of high-powered radar in the same frequency band which may interfere with or damage this device. However, devices found to interfere with primary licensing operations will be required to be removed at the user's expense.
5. This device shall be installed and operated in a completely enclosed container to prevent RF emissions, which can otherwise interfere with aeronautical navigation.
6. The installer/user of this device shall ensure that it is at least 10 km from the Dominion Astrophysical Radio Observatory (DRAO) near Penticton, British

Columbia. The coordinates of the DRAO are latitude 49°19'15"N and longitude 119°37'12" W. For devices not meeting this 10 km separation (e.g., those in the Okanagan Valley, British Columbia,) the installer/user must coordinate with, and obtain the written concurrence of, the Director of the DRAO before the equipment can be installed or operated. The Director of the DRAO may be contacted at 250-497-2300 (tel.) or 250-497-2355 (fax). (Alternatively, the Manager, Regulatory Standards, Industry Canada, may be contacted.)

Le présent appareil est conforme aux CNR d'Industrie Canada applicables aux appareils radio exempts de licence. L'exploitation est autorisée aux conditions suivantes:

1. l'appareil ne doit pas produire de brouillage.
2. l'appareil doit accepter tout brouillage radioélectrique subi, même si le brouillage est susceptible d'en compromettre le fonctionnement.
3. L'installation d'un dispositif TLPR doit être effectuée par des installateurs qualifiés, en pleine conformité avec les instructions du fabricant.
4. Ce dispositif ne peut être exploité qu'en régime de non-brouillage et de non-protection, c'est-à-dire que l'utilisateur doit accepter que des radars de haute puissance de la même bande de fréquences puissent brouiller ce dispositif ou même l'endommager. D'autre part, les capteurs de niveau qui perturbent une exploitation autorisée par licence de fonctionnement principal doivent être enlevés aux frais de leur utilisateur.
5. Un dispositif visé comme TLPR doit être installé et exploité dans un réservoir entièrement fermé afin de prévenir les rayonnements RF qui pourraient autrement perturber la navigation aéronautique.
6. La personne qui installe/utilise ce capteur de niveau doit s'assurer qu'il se trouve à au moins 10 km de l'Observatoire fédéral de radioastrophysique (OFR) de Penticton en Colombie-Britannique. Les coordonnées de l'OFR sont: latitude N 49° 19' 15", longitude O 119° 37' 12". La personne qui installe/utilise un dispositif ne pouvant respecter cette distance de 10 km (p. ex. dans la vallée de l'Okanagan [Colombie-Britannique]) doit se concerter avec le directeur de l'OFR afin d'obtenir de sa part une autorisation écrite avant que l'équipement ne puisse être installé ou mis en marche. Le directeur de l'OFR peut être contacté au 250-497-2300 (tél.) ou au 250-497-2355 (fax). (Le Directeur des Normes réglementaires d'Industrie Canada peut également être contacté).

Certificate 2827A-1408T

B.7 Radio Equipment Directive (RED) 2014/53/EU and Radio Equipment Regulations S.I. 2017/1206

Rosemount 1408H complies with ETSI EN 302 372 (TLPR) and EN 62311.

TLPR (Tank Level Probing Radar)

The device must be installed in closed tanks. Install according to requirements in ETSI EN 302 372 (Annex E).

Performance under the influence of an interferer signal

For the receiver test that covers the influence of an interferer signal to the device, the performance criterion has at least the following level of performance according to ETSI TS 103 361 [6].

- Performance criterion: measurement value variation Δd over time during a distance measurement
- Level of performance: $\Delta d \leq \pm 2 \text{ mm}$

B.8 Radio/EMC Republic of Korea

Registration number R-R-Rtr-1408

B.9 Additional certifications

B.9.1 3-A[®]

Certificate Authorization Number 3626

Standard 3-A Sanitary Standards for Number 74-07 (Sensors and Sensor Fittings and Connections)

B.9.2 Materials of construction

The hygienic approvals and certificates of the transmitter rely upon the following materials used in its construction:

Table B-1: Product Contact Surfaces

Item	Material	Compliant with
PTFE sealing	PTFE fluoropolymer	21 CFR 177.1550 EC 10/2011 TSE/BSE Free
Hygienic adapter	Stainless steel 300 series	TSE/BSE Free
Hygienic adapter O-ring	FKM or EPDM	21 CFR 177.2600 TSE/BSE Free

Table B-2: Nonproduct Contact Surfaces

Item	Material
Housing	Stainless steel 300 series
Bushing	Stainless steel 300 series
Plug	Stainless steel 300 series
Adapter seal	FKM
Electrical connector	Contact pins in gold plated brass Housing in plastics (PA) Seal in FKM

C Configuration parameters

C.1 Menu tree

Figure C-1: Parameter

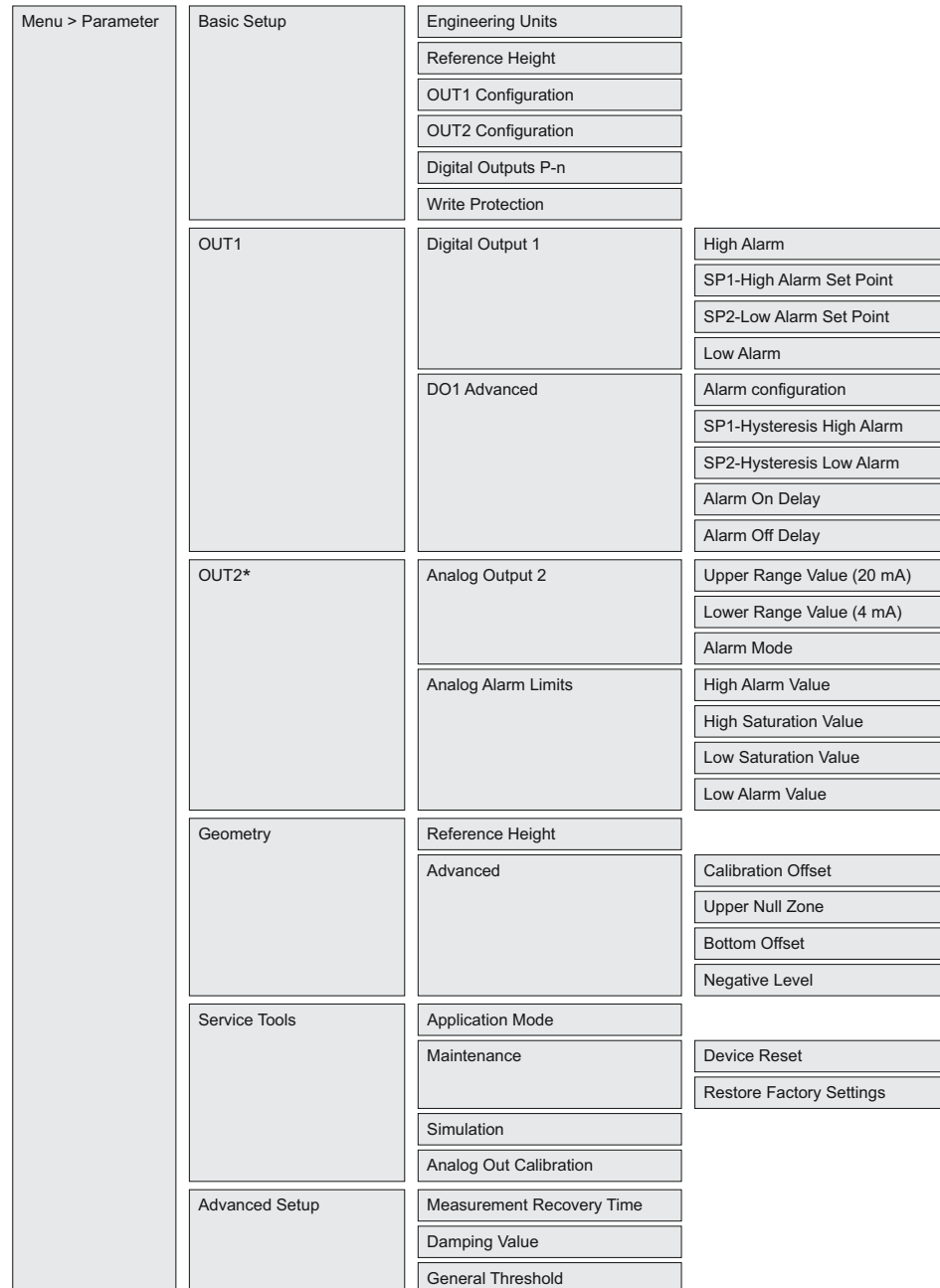

* Contains the same sub-menus as OUT1 when the OUT2 is configured for digital output.

C.2 Basic setup

C.2.1 Engineering units

Sets the unit of measure for length and temperature.

Option	Length unit	Temperature unit
Metric	m	°C
Imperial	inch	°F

After appropriate units have been selected, all configuration parameters and transmitter variables will be expressed in these units.

C.2.2 Reference height

Distance between the Device Reference Point and Zero Level.

Figure C-2: Reference Height

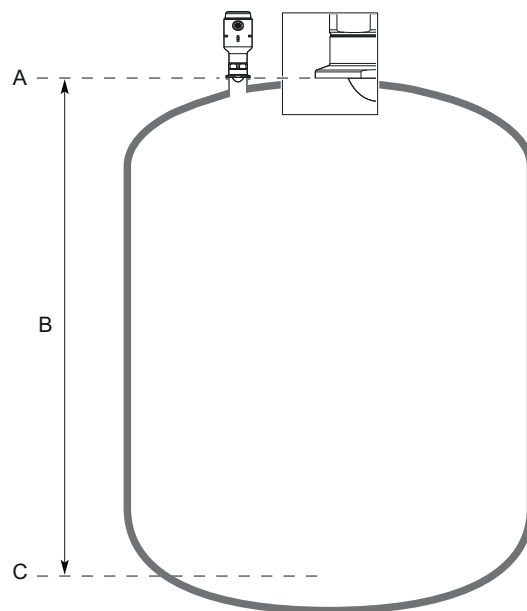

- A. Device Reference Point
- B. Reference Height
- C. Zero Level

Ensure the Reference Height is set as accurate as possible. The transmitter measures the distance to the product surface and subtracts this value from the Reference Height to determine the level.

Related information

[Enter the reference height](#)

C.2.3 OUT1 configuration

Output 1 provides a digital output for high/low level limits and IO-Link communication.

Table C-1: Options for OUT1

Option	Description
Disabled	N/A
Digital Output Normally Open	Switching signal for high and low level limits

If set to Disabled, the transmitter may still be operated in IO-Link mode.

Related information

[Digital output](#)

C.2.4 OUT2 configuration

Output 2 can perform one of these functions:

Table C-2: Options for OUT2

Option	Description
Disabled	N/A
Analog Output 4-20 mA	Analog 4-20 mA signal proportional to the level
Digital Output Normally Open	Switching signal for high and low level limits

Related information

[Digital output](#)

[Analog output](#)

C.2.5 Digital output P-n

The output polarity for the switching outputs (PnP or nPn).

C.2.6 Write protection

The transmitter can be software write protected to prevent unintentional configuration changes.

C.3 Digital output

C.3.1 Alarm configuration

High alarm

Enable or disable the high level alarm (overflow alarm).

Figure C-3: Example - High Alarm

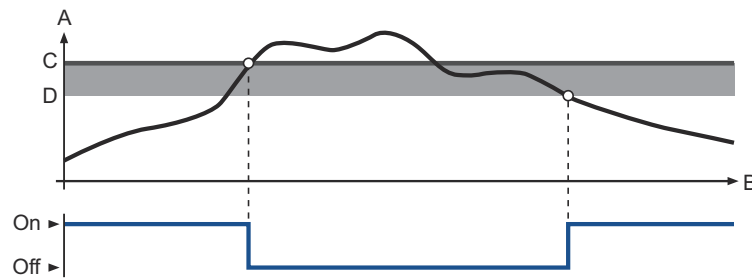

- A. Level
- B. Time
- C. SP1 - High alarm set point
- D. SP1 - Hysteresis high alarm

Low alarm

Enable or disable the low level alarm (dry run alarm).

Figure C-4: Example - Low Alarm

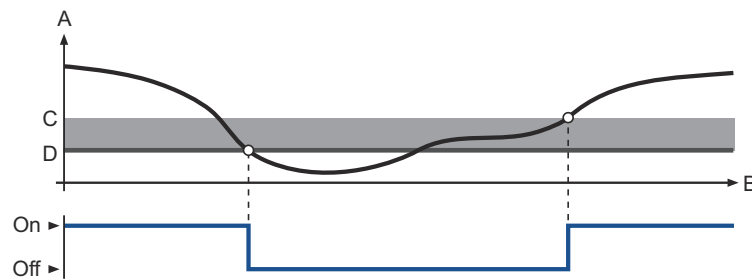

- A. Level
- B. Time
- C. SP2 - Hysteresis low alarm
- D. SP2 - Low alarm set point

Alarm set points

SP1 - High alarm set point

If the measured level is above this set point, the digital output is set to alarm state.

SP2 - Low alarm set point

If the measured level is below this set point, the digital output is set to alarm state.

Hysteresis

The hysteresis is a buffer zone so the alerts do not toggle on and off when the measurement value fluctuates around the alarm limit. The alarm is set when the value exceeds the alarm limit. The alarm is then cleared when the value falls outside the hysteresis zone.

SP1 - Hysteresis high alarm

Hysteresis zone for the high alarm.

SP2 - Hysteresis low alarm

Hysteresis zone for the low alarm.

Alarm delays

Alarm on delay

The time delay for when the digital output transfers from normal to alarm state.

Alarm off delay

The time delay for when the digital output transfers from alarm state to normal.

Figure C-5: Example - High Alarm with Alarm Delays

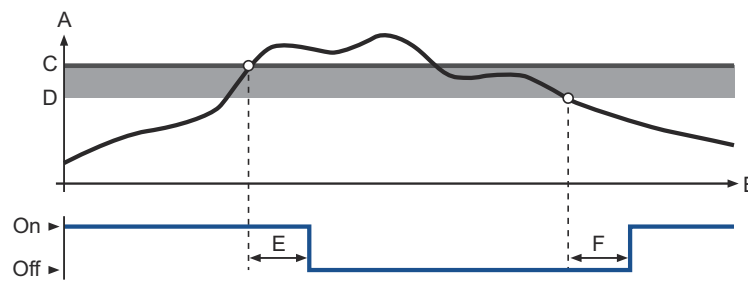

- A. Level
- B. Time
- C. SP1 - High alarm set point
- D. SP1 - Hysteresis high alarm
- E. Alarm on delay
- F. Alarm off delay

Options for alarm on delay

Table C-3: Alarm On Delay

Option	Description
Always	Alarm on delay is always used.
Lost surface	Alarm on delay is used only for lost surface alarms. This may be useful in applications when there are small and local rapid level changes caused by surface turbulence. Hardware faults and measurement values that exceed the alarm set points will trigger alarm without any delay.

Figure C-6: Behavior of the Alarm On Delay

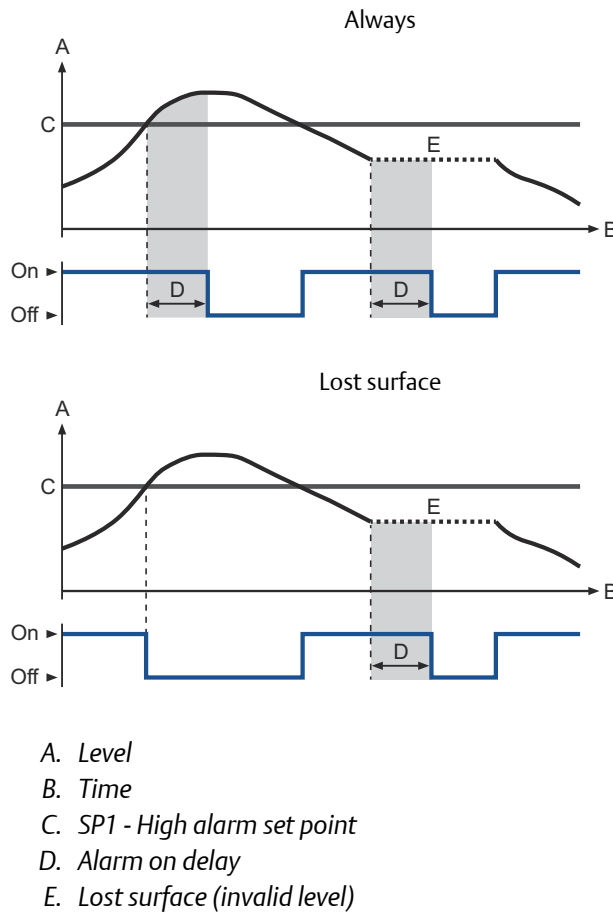

C.4 Analog output

C.4.1 Upper/lower range value

Enter the range values that correspond to the analog output values 4 and 20 mA. In normal operation, the transmitter will drive the output in response to level from the lower to upper saturation points.

Note

The 20 mA point should be set below the reduced accuracy zone at the top of the tank.

Figure C-7: Example of Range Value Settings

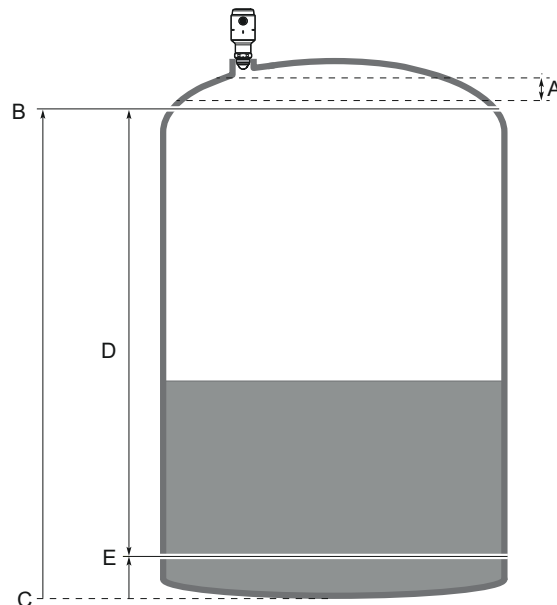

- A. Reduced accuracy zone
- B. 100% (20 mA)
- C. Zero Level
- D. Level measurement range 0-100%
- E. 0% (4 mA)

Related information

[Accuracy over measuring range](#)

C.4.2 Alarm mode

The transmitter automatically and continuously performs self-diagnostic routines. If a failure or a measurement error is detected, the transmitter drives the output to selected alarm limit (high or low).

C.4.3 Analog alarm limits

High/low alarm value

The high/low alarm current for the analog output when the device enters the alarm mode.

Related information

[Analog signal on alarm](#)

High/low saturation value

The device will continue to set a current that corresponds with the measurement until reaching the upper/lower limit (and then freeze).

Related information

[Analog saturation levels](#)

C.5 Geometry

C.5.1 Advanced

Calibration offset

Difference between surface distance measured by transmitter and the same distance measured by, for example, hand-dipping with a measurement tape. A positive Calibration Offset value will increase the presented level value.

Figure C-8: Calibration Offset

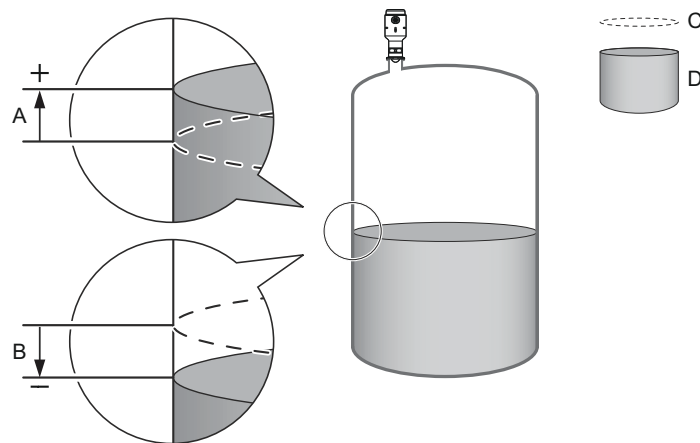

- A. Positive Calibration Offset value
- B. Negative Calibration Offset value
- C. Reported level
- D. Actual level

Upper null zone

The Upper Null Zone defines how close to the transmitter's reference point a level value is accepted. You can extend this value to block out disturbing echoes close to the antenna, for example from the tank nozzle.

Note

Make sure the 20 mA value is below the Upper Null Zone. Measurements are not performed within the Upper Null Zone (UNZ).

Related information

[Change the upper null zone](#)

Bottom offset

The Bottom Offset is defined as the distance between Zero Level and the tank bottom. The default value is zero.

If the Zero Level is not located at the tank bottom, then enter a Bottom Offset. It is needed for the transmitter to know the position of the tank bottom.

Figure C-9: Bottom Offset

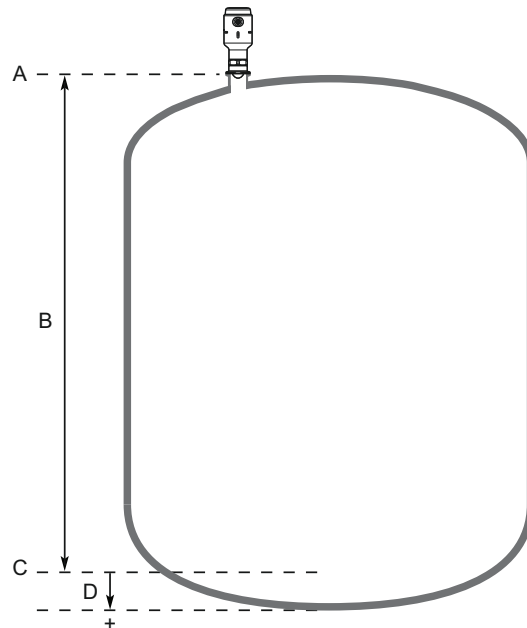

- A. Device Reference Point
- B. Reference Height
- C. Zero Level
- D. Bottom Offset

Negative level

If Bottom Offset is greater than zero, the level value can be negative. This parameter determines if the shown level value can be negative or zero.

Table C-4: Negative Level

Option	Description
Equals zero	When this setting is selected and the product surface is at or below Zero Level, the level measurement output will be zero.
Allowed	Negative level values are allowed.

C.6 Advanced setup

C.6.1 Measurement recovery time

The Measurement Recovery Time (Echo Timeout) parameter controls the maximum time from when measurement is lost (e.g. due to process conditions such as foam or turbulence) until it is annunciated. If measurement is recovered within the time specified by this parameter, then it will not be annunciated.

C.6.2 Damping value

This parameter defines how fast the transmitter reacts to a change of the level value (step response). The default value is 2 seconds.

A high value makes the level reading steady, while a low value allows the transmitter to respond to rapid level changes (but the presented level value may be less steady).

C.6.3 General threshold

The general threshold is used to filter out noise and disturbing echoes from the product surface echo. The transmitter uses certain criteria to decide which type of echo peak that is detected. Only echoes above the general threshold might be considered the product surface.

Figure C-10: Threshold Principle

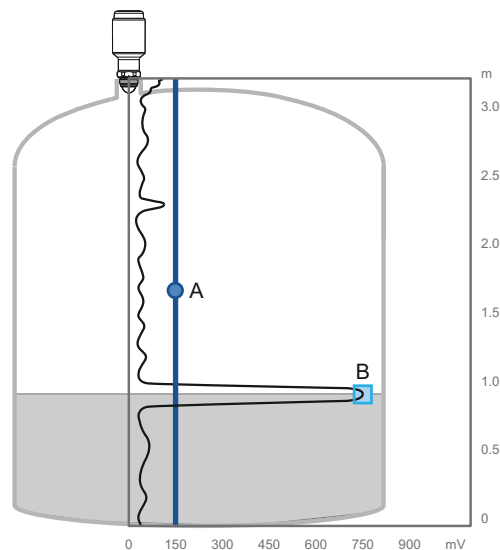

- A. General threshold
- B. Product surface echo

Related information

[Adjust the general threshold](#)

For more information: www.emerson.com

©2021 Emerson. All rights reserved.

Emerson Terms and Conditions of Sale are available upon request. The Emerson logo is a trademark and service mark of Emerson Electric Co. Rosemount is a mark of one of the Emerson family of companies. All other marks are the property of their respective owners.

ROSEMOUNT™

