

Operating Instructions

Proline Promag P 200

HART

Electromagnetic flowmeter

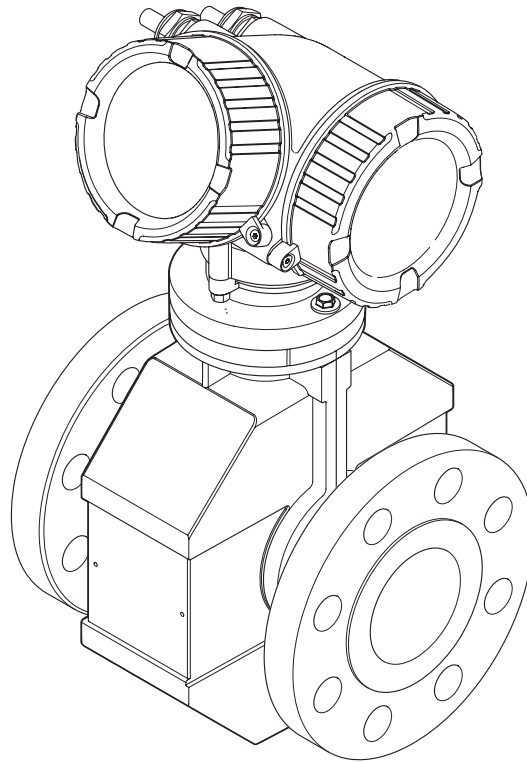

- Make sure the document is stored in a safe place such that it is always available when working on or with the device.
- To avoid danger to individuals or the facility, read the "Basic safety instructions" section carefully, as well as all other safety instructions in the document that are specific to working procedures.
- The manufacturer reserves the right to modify technical data without prior notice. Your Endress+Hauser Sales Center will supply you with current information and updates to these Instructions.

Table of contents

1	Document information	6		
1.1	Document function	6		
1.2	Symbols used	6		
1.2.1	Safety symbols	6		
1.2.2	Electrical symbols	6		
1.2.3	Tool symbols	6		
1.2.4	Symbols for certain types of information	7		
1.2.5	Symbols in graphics	7		
1.3	Documentation	7		
1.3.1	Standard documentation	8		
1.3.2	Supplementary device-dependent documentation	8		
1.4	Registered trademarks	8		
2	Basic safety instructions	9		
2.1	Requirements for the personnel	9		
2.2	Designated use	9		
2.3	Workplace safety	10		
2.4	Operational safety	10		
2.5	Product safety	10		
2.6	IT security	11		
3	Product description	12		
3.1	Product design	12		
4	Incoming acceptance and product identification	13		
4.1	Incoming acceptance	13		
4.2	Product identification	13		
4.2.1	Transmitter nameplate	14		
4.2.2	Sensor nameplate	15		
4.2.3	Symbols on measuring device	16		
5	Storage and transport	17		
5.1	Storage conditions	17		
5.2	Transporting the product	17		
5.2.1	Measuring devices without lifting lugs	17		
5.2.2	Measuring devices with lifting lugs	18		
5.2.3	Transporting with a fork lift	18		
5.3	Packaging disposal	18		
6	Installation	19		
6.1	Installation conditions	19		
6.1.1	Mounting position	19		
6.1.2	Requirements from environment and process	21		
6.1.3	Special mounting instructions	23		
6.2	Mounting the measuring device	23		
6.2.1	Required tools	23		
6.2.2	Preparing the measuring device	23		
6.2.3	Mounting the sensor	24		
6.2.4	Turning the transmitter housing	27		
6.2.5	Turning the display module	28		
6.3	Post-installation check	28		
7	Electrical connection	29		
7.1	Connection conditions	29		
7.1.1	Required tools	29		
7.1.2	Requirements for connecting cable	29		
7.1.3	Terminal assignment	30		
7.1.4	Requirements for the supply unit	30		
7.1.5	Preparing the measuring device	31		
7.2	Connecting the measuring device	31		
7.2.1	Connecting the transmitter	31		
7.2.2	Ensuring potential equalization	33		
7.3	Special connection instructions	35		
7.3.1	Connection examples	35		
7.4	Ensuring the degree of protection	36		
7.5	Post-connection check	37		
8	Operation options	38		
8.1	Overview of operation options	38		
8.2	Structure and function of the operating menu	39		
8.2.1	Structure of the operating menu	39		
8.2.2	Operating philosophy	40		
8.3	Access to the operating menu via the local display	41		
8.3.1	Operational display	41		
8.3.2	Navigation view	42		
8.3.3	Editing view	44		
8.3.4	Operating elements	46		
8.3.5	Opening the context menu	46		
8.3.6	Navigating and selecting from list	48		
8.3.7	Calling the parameter directly	48		
8.3.8	Calling up help text	49		
8.3.9	Changing the parameters	50		
8.3.10	User roles and related access authorization	51		
8.3.11	Disabling write protection via access code	51		
8.3.12	Enabling and disabling the keypad lock	51		
8.4	Access to the operating menu via the operating tool	52		
8.4.1	Connecting the operating tool	53		
8.4.2	Field Xpert SFX350, SFX370	54		
8.4.3	FieldCare	54		
8.4.4	AMS Device Manager	55		
8.4.5	SIMATIC PDM	55		
8.4.6	Field Communicator 475	56		

9	System integration	57	12.2	Diagnostic information on local display	99
9.1	Overview of device description files	57	12.2.1	Diagnostic message	99
9.1.1	Current version data for the device	57	12.2.2	Calling up remedial measures	101
9.1.2	Operating tools	57	12.3	Diagnostic information in FieldCare	101
9.2	Measured variables via HART protocol	57	12.3.1	Diagnostic options	101
9.3	Other settings	58	12.3.2	Calling up remedy information	102
9.3.1	Burst mode functionality in accordance with HART 7 Specification	58	12.4	Adapting the diagnostic information	103
			12.4.1	Adapting the diagnostic behavior	103
			12.4.2	Adapting the status signal	103
10	Commissioning	61	12.5	Overview of diagnostic information	104
10.1	Function check	61	12.6	Pending diagnostic events	106
10.2	Switching on the measuring device	61	12.7	Diagnostic list	107
10.3	Setting the operating language	61	12.8	Event logbook	107
10.4	Configuring the measuring device	61	12.8.1	Event history	107
10.4.1	Defining the tag name	62	12.8.2	Filtering the event logbook	108
10.4.2	Setting the system units	63	12.8.3	Overview of information events	108
10.4.3	Configuring the current output	65	12.9	Resetting the measuring device	109
10.4.4	Configuring the pulse/frequency/switch output	66	12.9.1	Function scope of "Device reset" parameter	110
10.4.5	Configuring the local display	73	12.10	Device information	110
10.4.6	Configuring the output conditioning	75	12.11	Firmware history	112
10.4.7	Configuring the low flow cut off	76	13	Maintenance	113
10.4.8	Configuring empty pipe detection	78	13.1	Maintenance tasks	113
10.5	Advanced settings	79	13.1.1	Exterior cleaning	113
10.5.1	Carrying out a sensor adjustment	80	13.1.2	Interior cleaning	113
10.5.2	Configuring the totalizer	80	13.1.3	Replacing seals	113
10.5.3	Carrying out additional display configurations	82	13.2	Measuring and test equipment	113
10.5.4	Administration configuration	84	13.3	Endress+Hauser services	113
10.6	Configuration management	85	14	Repair	114
10.6.1	Function range of "Configuration management" parameter	86	14.1	General notes	114
10.7	Simulation	86	14.2	Spare parts	114
10.8	Protecting settings from unauthorized access	88	14.3	Endress+Hauser services	115
10.8.1	Write protection via access code	88	14.4	Return	115
10.8.2	Write protection via write protection switch	89	14.5	Disposal	115
			14.5.1	Removing the measuring device	115
			14.5.2	Disposing of the measuring device	116
11	Operation	91	15	Accessories	117
11.1	Reading the device locking status	91	15.1	Device-specific accessories	117
11.2	Adjusting the operating language	91	15.1.1	For the transmitter	117
11.3	Configuring the display	91	15.1.2	For the sensor	118
11.4	Reading measured values	91	15.2	Communication-specific accessories	118
11.4.1	Process variables	91	15.3	Service-specific accessories	118
11.4.2	Totalizer	92	15.4	System components	119
11.4.3	Output values	92	16	Technical data	120
11.5	Adapting the measuring device to the process conditions	93	16.1	Application	120
11.6	Performing a totalizer reset	93	16.2	Function and system design	120
11.7	Showing data logging	94	16.3	Input	120
12	Diagnostics and troubleshooting	97	16.4	Output	121
12.1	General troubleshooting	97	16.5	Power supply	124
			16.6	Performance characteristics	125
			16.7	Installation	126
			16.8	Environment	127

16.9	Process	127
16.10	Mechanical construction	129
16.11	Operability	133
16.12	Certificates and approvals	135
16.13	Application packages	136
16.14	Accessories	137
16.15	Documentation	137
Index	139





1 Document information

1.1 Document function







These Operating Instructions contain all the information that is required in various phases of the life cycle of the device: from product identification, incoming acceptance and storage, to mounting, connection, operation and commissioning through to troubleshooting, maintenance and disposal.

1.2 Symbols used



1.2.1 Safety symbols

Symbol	Meaning
	DANGER! This symbol alerts you to a dangerous situation. Failure to avoid this situation will result in serious or fatal injury.
	WARNING! This symbol alerts you to a dangerous situation. Failure to avoid this situation can result in serious or fatal injury.
	CAUTION! This symbol alerts you to a dangerous situation. Failure to avoid this situation can result in minor or medium injury.
	NOTE! This symbol contains information on procedures and other facts which do not result in personal injury.





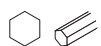





1.2.2 Electrical symbols

Symbol	Meaning	Symbol	Meaning
	Direct current		Alternating current
	Direct current and alternating current		Ground connection A grounded terminal which, as far as the operator is concerned, is grounded via a grounding system.
	Protective ground connection A terminal which must be connected to ground prior to establishing any other connections.		Equipotential connection A connection that has to be connected to the plant grounding system: This may be a potential equalization line or a star grounding system depending on national or company codes of practice.





1.2.3 Tool symbols

Symbol	Meaning
	Flat blade screwdriver
	Allen key
	Open-ended wrench



1.2.4 Symbols for certain types of information

Symbol	Meaning
	Permitted Procedures, processes or actions that are permitted.
	Preferred Procedures, processes or actions that are preferred.
	Forbidden Procedures, processes or actions that are forbidden.
	Tip Indicates additional information.
	Reference to documentation
	Reference to page
	Reference to graphic
	Series of steps
	Result of a sequence of actions
	Help in the event of a problem
	Visual inspection

1.2.5 Symbols in graphics

Symbol	Meaning	Symbol	Meaning
1, 2, 3,...	Item numbers		Series of steps
A, B, C, ...	Views	A-A, B-B, C-C, ...	Sections
	Hazardous area		Safe area (non-hazardous area)
	Flow direction		

1.3 Documentation

-  For an overview of the scope of the associated Technical Documentation, refer to the following:
 - The CD-ROM provided for the device (depending on the device version, the CD-ROM might not be part of the delivery!)
 - The *W@M Device Viewer* : Enter the serial number from the nameplate (www.endress.com/deviceviewer)
 - The *Endress+Hauser Operations App*: Enter the serial number from the nameplate or scan the 2-D matrix code (QR code) on the nameplate.
-  For a detailed list of the individual documents along with the documentation code

1.3.1 Standard documentation

Document type	Purpose and content of the document
Technical Information	Planning aid for your device The document contains all the technical data on the device and provides an overview of the accessories and other products that can be ordered for the device.
Brief Operating Instructions	Guide that takes you quickly to the 1st measured value The Brief Operating Instructions contain all the essential information from incoming acceptance to initial commissioning.

1.3.2 Supplementary device-dependent documentation

Additional documents are supplied depending on the device version ordered: Always comply strictly with the instructions in the supplementary documentation. The supplementary documentation is an integral part of the device documentation.

1.4 Registered trademarks

HART®

Registered trademark of the HART Communication Foundation, Austin, USA

Applicator®, FieldCare®, Field Xpert™, HistoROM®, Heartbeat Technology™

Registered or registration-pending trademarks of the Endress+Hauser Group

2 Basic safety instructions

2.1 Requirements for the personnel

The personnel for installation, commissioning, diagnostics and maintenance must fulfill the following requirements:

- ▶ Trained, qualified specialists must have a relevant qualification for this specific function and task
- ▶ Are authorized by the plant owner/operator
- ▶ Are familiar with federal/national regulations
- ▶ Before beginning work, the specialist staff must have read and understood the instructions in the Operating Instructions and supplementary documentation as well as in the certificates (depending on the application)
- ▶ Following instructions and basic conditions

The operating personnel must fulfill the following requirements:

- ▶ Being instructed and authorized according to the requirements of the task by the facility's owner-operator
- ▶ Following the instructions in these Operating Instructions

2.2 Designated use

Application and media

The measuring device is only suitable for flow measurement of liquids with a minimum conductivity of 20 $\mu\text{S}/\text{cm}$.

Depending on the version ordered, the measuring device can also measure potentially explosive, flammable, poisonous and oxidizing media.

Measuring devices for use in hazardous areas, in hygienic applications or in applications where there is an increased risk due to process pressure, are labeled accordingly on the nameplate.

To ensure that the measuring device remains in proper condition for the operation time:

- ▶ Only use the measuring device in full compliance with the data on the nameplate and the general conditions listed in the Operating Instructions and supplementary documentation.
- ▶ Check the nameplate to verify if the device ordered can be put to its intended use in the approval-related area (e.g. explosion protection, pressure vessel safety).
- ▶ Use the measuring device only for media against which the process-wetted materials are adequately resistant.
- ▶ If the measuring device is not operated at atmospheric temperature, compliance with the relevant basic conditions specified in the associated device documentation is absolutely essential: "Documentation" section →  7.
- ▶ Protect the measuring device permanently against corrosion from environmental influences.

Incorrect use

Non-designated use can compromise safety. The manufacturer is not liable for damage caused by improper or non-designated use.

WARNING

Danger of breakage of the sensor due to corrosive or abrasive fluids or from environmental conditions!

- ▶ Verify the compatibility of the process fluid with the sensor material.
- ▶ Ensure the resistance of all fluid-wetted materials in the process.
- ▶ Keep within the specified pressure and temperature range.

Verification for borderline cases:

- ▶ For special fluids and fluids for cleaning, Endress+Hauser is glad to provide assistance in verifying the corrosion resistance of fluid-wetted materials, but does not accept any warranty or liability as minute changes in the temperature, concentration or level of contamination in the process can alter the corrosion resistance properties.

Residual risks

The external surface temperature of the housing can increase by max. 10 K due to the power consumption of the electronic components. Hot process fluids passing through the measuring device will further increase the surface temperature of the housing. The surface of the sensor, in particular, can reach temperatures which are close to the fluid temperature.

Possible burn hazard due to fluid temperatures!

- ▶ For elevated fluid temperature, ensure protection against contact to prevent burns.

2.3 Workplace safety

For work on and with the device:

- ▶ Wear the required personal protective equipment according to federal/national regulations.

For welding work on the piping:

- ▶ Do not ground the welding unit via the measuring device.

If working on and with the device with wet hands:

- ▶ It is recommended to wear gloves on account of the higher risk of electric shock.

2.4 Operational safety

Risk of injury.

- ▶ Operate the device in proper technical condition and fail-safe condition only.
- ▶ The operator is responsible for interference-free operation of the device.

Conversions to the device

Unauthorized modifications to the device are not permitted and can lead to unforeseeable dangers.

- ▶ If, despite this, modifications are required, consult with Endress+Hauser.

Repair

To ensure continued operational safety and reliability,

- ▶ Carry out repairs on the device only if they are expressly permitted.
- ▶ Observe federal/national regulations pertaining to repair of an electrical device.
- ▶ Use original spare parts and accessories from Endress+Hauser only.

2.5 Product safety

This measuring device is designed in accordance with good engineering practice to meet state-of-the-art safety requirements, has been tested, and left the factory in a condition in which it is safe to operate.

It meets general safety standards and legal requirements. It also complies with the EC directives listed in the device-specific EC Declaration of Conformity. Endress+Hauser confirms this by affixing the CE mark to the device.

2.6 IT security

We only provide a warranty if the device is installed and used as described in the Operating Instructions. The device is equipped with security mechanisms to protect it against any inadvertent changes to the device settings.

IT security measures in line with operators' security standards and designed to provide additional protection for the device and device data transfer must be implemented by the operators themselves.

3 Product description

The device consists of a transmitter and a sensor.

One device version is available: compact version - transmitter and sensor form a mechanical unit.

3.1 Product design

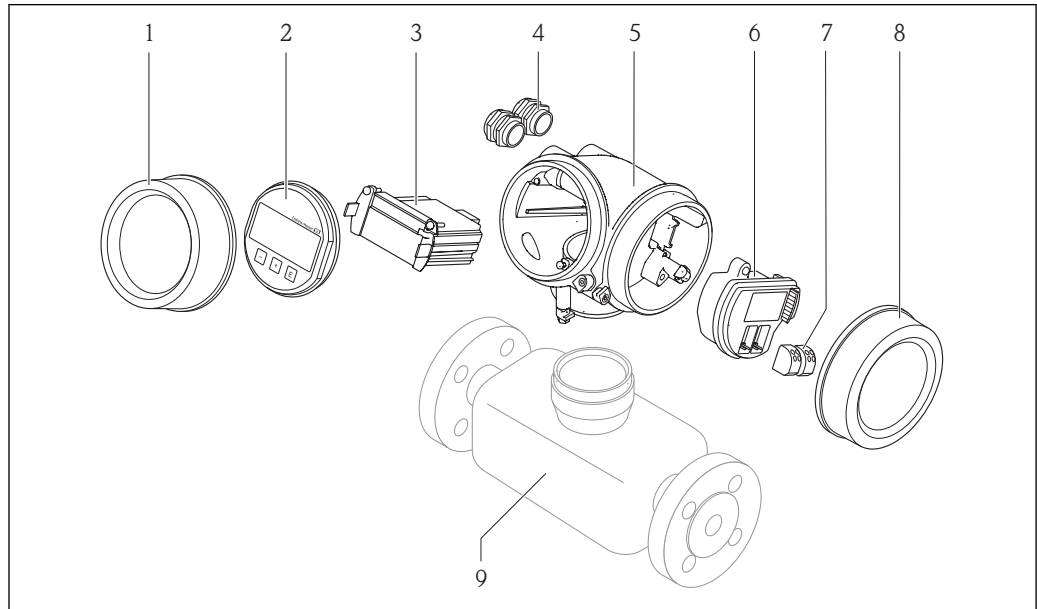

A0014056

1 Important components of a measuring device

- 1 Electronics compartment cover
- 2 Display module
- 3 Main electronics module
- 4 Cable glands
- 5 Transmitter housing (incl. integrated HistoROM)
- 6 I/O electronics module
- 7 Terminals (spring loaded terminals, pluggable)
- 8 Connection compartment cover
- 9 Sensor (incl. HistoROM S-DAT)

4 Incoming acceptance and product identification

4.1 Incoming acceptance

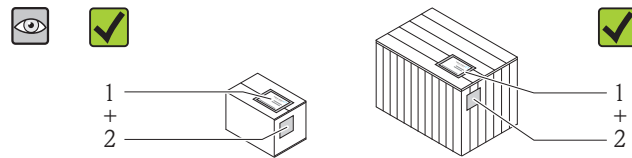

Are the order codes on the delivery note (1) and the product sticker (2) identical?

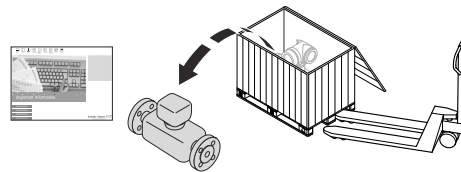

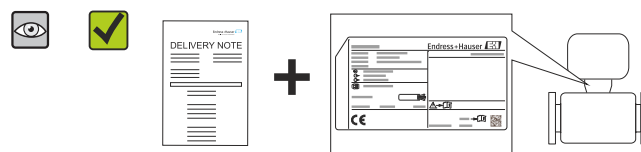

Are the goods undamaged?

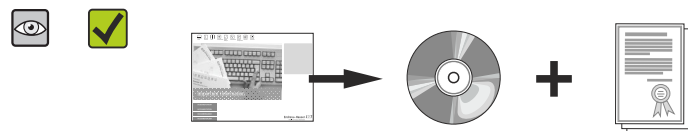

Do the nameplate data match the ordering information on the delivery note?



Is the CD-ROM with the Technical Documentation (depends on device version) and documents present?



-  If one of the conditions is not satisfied, contact your Endress+Hauser Sales Center.
- Depending on the device version, the CD-ROM might not be part of the delivery! The Technical Documentation is available via the Internet or via the *Endress+Hauser Operations App*, see the "Product identification" section →  14.

4.2 Product identification

The following options are available for identification of the measuring device:

- Nameplate specifications
- Order code with breakdown of the device features on the delivery note
- Enter serial numbers from nameplates in *W@M Device Viewer* (www.endress.com/deviceviewer): All information about the measuring device is displayed.
- Enter the serial number from the nameplates into the *Endress+Hauser Operations App* or scan the 2-D matrix code (QR code) on the nameplate with the *Endress+Hauser Operations App*: all the information for the measuring device is displayed.

For an overview of the scope of the associated Technical Documentation, refer to the following:

- The chapters "Additional standard documentation on the device" →  8 and "Supplementary device-dependent documentation" →  8
- The *W@M Device Viewer*: Enter the serial number from the nameplate (www.endress.com/deviceviewer)
- The *Endress+Hauser Operations App*: Enter the serial number from the nameplate or scan the 2-D matrix code (QR code) on the nameplate.

4.2.1 Transmitter nameplate

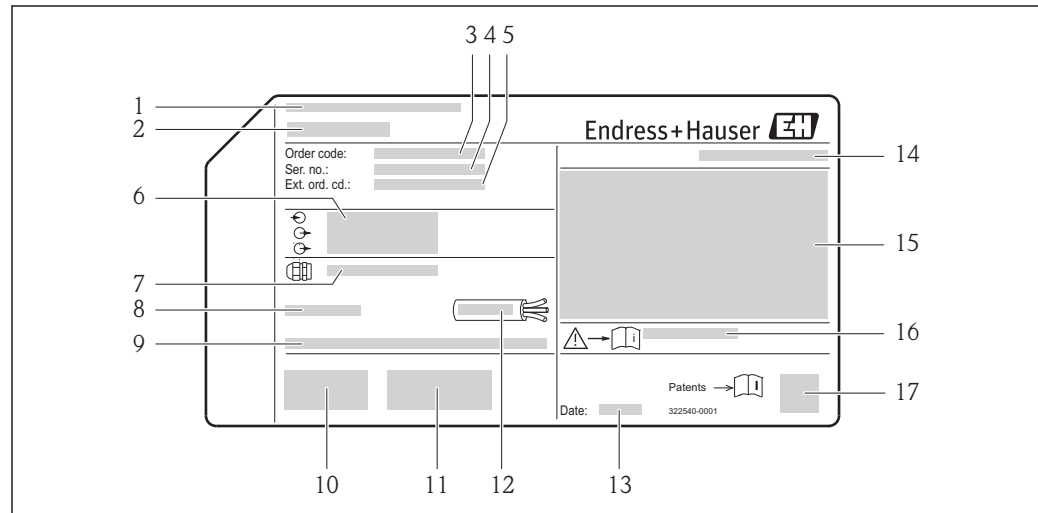

A0013906

 2 Example of a transmitter nameplate

- 1 Manufacturing location
- 2 Name of the transmitter
- 3 Order code
- 4 Serial number (Ser. no.)
- 5 Extended order code (Ext. ord. cd.)
- 6 Electrical connection data, e.g. available inputs and outputs, supply voltage
- 7 Type of cable glands
- 8 Permitted ambient temperature (T_a)
- 9 Firmware version (FW) and device revision (Dev.Rev.) from the factory
- 10 CE mark, C-Tick
- 11 Additional information on version: certificates, approvals
- 12 Permitted temperature range for cable
- 13 Manufacturing date: year-month
- 14 Degree of protection
- 15 Approval information for explosion protection
- 16 Document number of safety-related supplementary documentation
- 17 2-D matrix code

4.2.2 Sensor nameplate

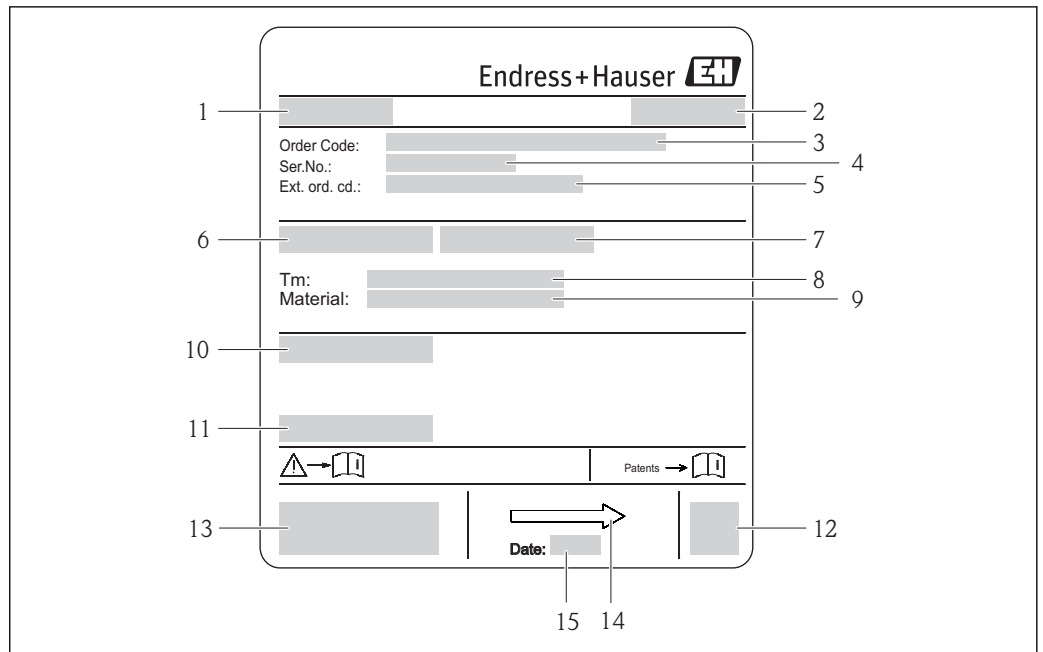

A0017186

3 Example of sensor nameplate

- 1 Name of the sensor
- 2 Manufacturing location
- 3 Order code
- 4 Serial number (ser. no.)
- 5 Extended order code (ext. ord. cd.)
- 6 Nominal diameter of sensor
- 7 Test pressure of the sensor
- 8 Fluid temperature range
- 9 Material of lining and electrodes
- 10 Degree of protection: e.g. IP, NEMA
- 11 Permitted ambient temperature (T_a)
- 12 2-D matrix code
- 13 CE mark, C-Tick
- 14 Flow direction
- 15 Manufacturing date: year-month



Order code

The measuring device is reordered using the order code.

Extended order code

- The device type (product root) and basic specifications (mandatory features) are always listed.
- Of the optional specifications (optional features), only the safety and approval-related specifications are listed (e.g. LA). If other optional specifications are also ordered, these are indicated collectively using the # placeholder symbol (e.g. #LA#).
- If the ordered optional specifications do not include any safety and approval-related specifications, they are indicated by the + placeholder symbol (e.g. XXXXXX-ABCDE+).

4.2.3 Symbols on measuring device

Symbol	Meaning
	WARNING! This symbol alerts you to a dangerous situation. Failure to avoid this situation can result in serious or fatal injury.
	Reference to documentation Refers to the corresponding device documentation.
	Protective ground connection A terminal which must be connected to ground prior to establishing any other connections.

5 Storage and transport

5.1 Storage conditions

Observe the following notes for storage:

- Store in the original packaging to ensure protection from shock.
- Do not remove protective covers or protective caps installed on process connections. They prevent mechanical damage to the sealing surfaces and contamination in the measuring tube.
- Protect from direct sunlight to avoid unacceptably high surface temperatures.
- Select a storage location where moisture cannot collect in the measuring device as fungus and bacteria infestation can damage the lining.
- Store in a dry and dust-free place.
- Do not store outdoors.
- Storage temperature →  127

5.2 Transporting the product

Transport the measuring device to the measuring point in the original packaging.

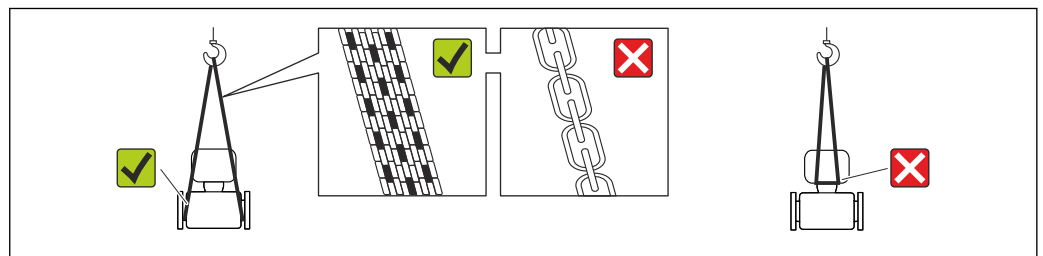

A0015604

-  Do not remove protective covers or caps installed on process connections. They prevent mechanical damage to the sealing surfaces and contamination in the measuring tube.

5.2.1 Measuring devices without lifting lugs

WARNING

Center of gravity of the measuring device is higher than the suspension points of the webbing slings.

Risk of injury if the measuring device slips.

- ▶ Secure the measuring device against slipping or turning.
- ▶ Observe the weight specified on the packaging (stick-on label).

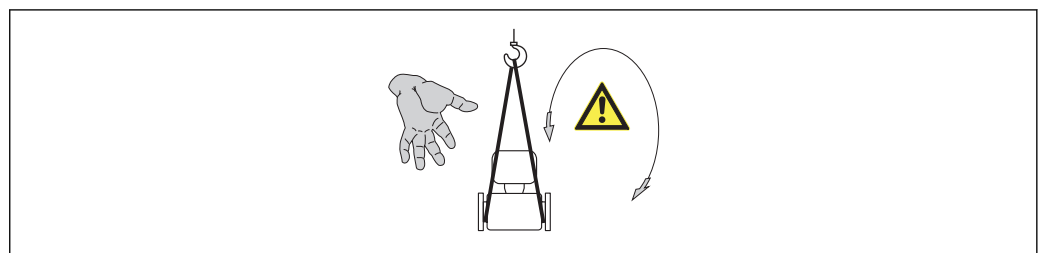

A0015606

5.2.2 Measuring devices with lifting lugs

⚠ CAUTION

Special transportation instructions for devices with lifting lugs

- ▶ Only use the lifting lugs fitted on the device or flanges to transport the device.
- ▶ The device must always be secured at two lifting lugs at least.

5.2.3 Transporting with a fork lift

If transporting in wood crates, the floor structure enables the crates to be lifted lengthwise or at both sides using a forklift.

⚠ CAUTION

Risk of damaging the magnetic coil

- ▶ If transporting by forklift, do not lift the sensor by the metal casing.
- ▶ This would buckle the casing and damage the internal magnetic coils.

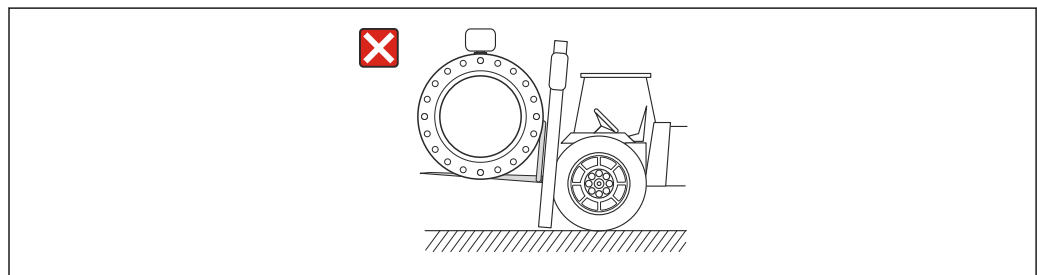

A0023726

5.3 Packaging disposal

All packaging materials are environmentally friendly and 100% recyclable:

- Measuring device secondary packaging: polymer stretch film that conforms to EC Directive 2002/95/EC (RoHS).
- Packaging:
 - Wood crate, treated in accordance with ISPM 15 standard, which is confirmed by the affixed IPPC logo.
 - or
 - Carton in accordance with European Packaging Directive 94/62EC; recyclability is confirmed by the affixed RESY symbol.
- Seaworthy packaging (optional): Wood crate, treated in accordance with ISPM 15 standard, which is confirmed by the affixed IPPC logo.
- Carrying and mounting hardware:
 - Disposable plastic pallet
 - Plastic straps
 - Plastic adhesive strips
- Dunnage: Paper cushion

6 Installation

6.1 Installation conditions

6.1.1 Mounting position

Mounting location

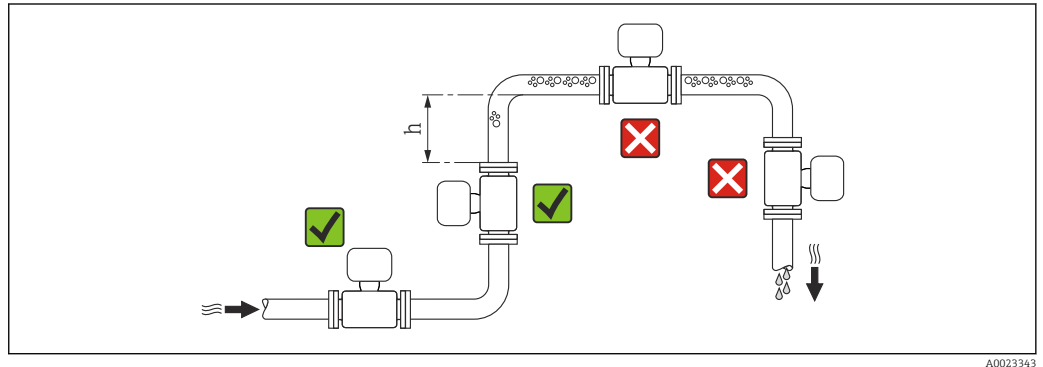

A0023343

Preferably install the sensor in an ascending pipe, and ensure a sufficient distance to the next pipe elbow: $h \geq 2 \times DN$

To prevent measuring errors arising from accumulation of gas bubbles in the measuring tube, avoid the following mounting locations in the pipe:

- Highest point of a pipeline.
- Directly upstream of a free pipe outlet in a down pipe.

Installation in down pipes

Install a siphon with a vent valve downstream of the sensor in down pipes whose length $h \geq 5 \text{ m}$ (16.4 ft). This precaution is to avoid low pressure and the consequent risk of damage to the measuring tube. This measure also prevents the system losing prime.

 For information on the liner's resistance to partial vacuum

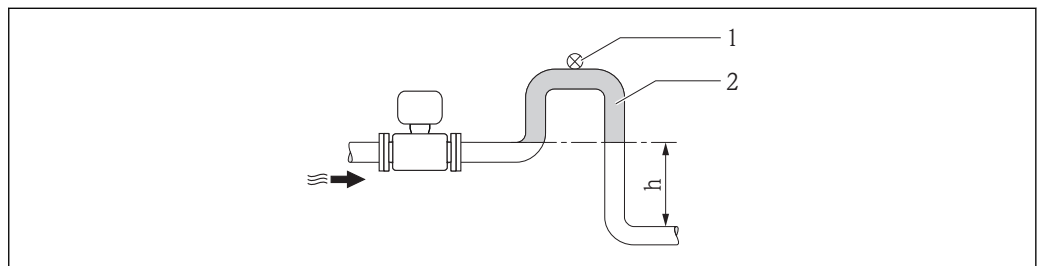

A0017064

 4 Installation in a down pipe

- 1 Vent valve
- 2 Pipe siphon
- h Length of down pipe

Installation in partially filled pipes

A partially filled pipe with a gradient necessitates a drain-type configuration.

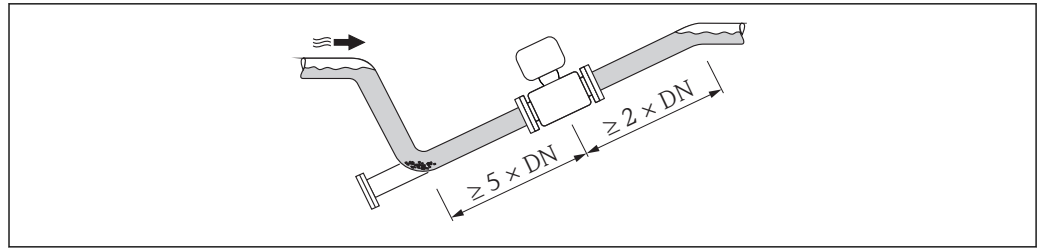

A0017063

Orientation

The direction of the arrow on the sensor nameplate helps you to install the sensor according to the flow direction (direction of medium flow through the piping).

An optimum orientation position helps avoid gas and air accumulations and deposits in the measuring tube.

The measuring device also offers the empty pipe detection function to detect partially filled measuring pipes in the event of outgassing fluids or variable process pressures.

Vertical

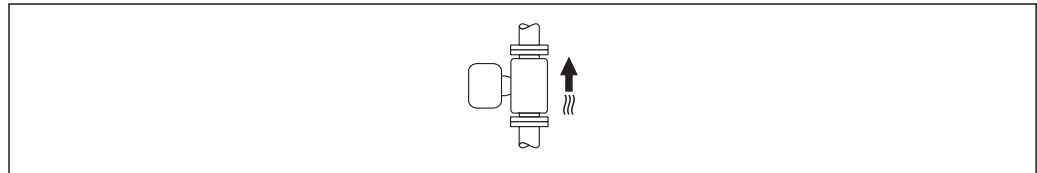

A0015591

Optimum for self-emptying pipe systems and for use in conjunction with empty pipe detection.

Horizontal

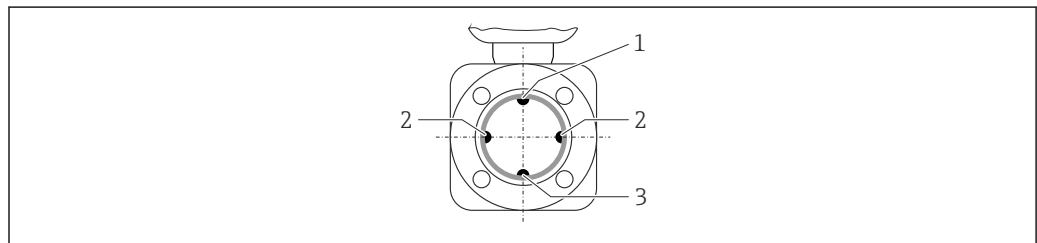

A0016260

- 1 EPD electrode for empty pipe detection
- 2 Measuring electrodes for signal detection
- 3 Reference electrode for potential equalization

- i** The measuring electrode plane must be horizontal. This prevents brief insulation of the two measuring electrodes by entrained air bubbles.
- Empty pipe detection only works if the transmitter housing is pointing upwards as otherwise there is no guarantee that the empty pipe detection function will actually respond to a partially filled or empty measuring tube.

Inlet and outlet runs

If possible, install the sensor upstream from fittings such as valves, T-pieces or elbows.

Observe the following inlet and outlet runs to comply with accuracy specifications:

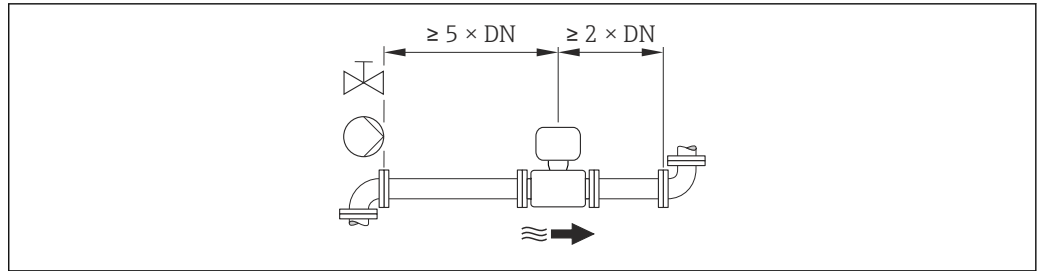

Installation dimensions

 For the dimensions and installation lengths of the device, see the "Technical Information" document, "Mechanical construction" section

6.1.2 Requirements from environment and process

Ambient temperature range

Transmitter	-40 to +60 °C (-40 to +140 °F)
Local display	-20 to +60 °C (-4 to +140 °F), the readability of the display may be impaired at temperatures outside the temperature range.
Sensor	<ul style="list-style-type: none"> ▪ Process connection material, carbon steel: -10 to +60 °C (+14 to +140 °F) ▪ Process connection material, stainless steel: -40 to +60 °C (-40 to +140 °F)
Liner	Do not exceed or fall below the permitted temperature range of the liner .

If operating outdoors:

- Install the measuring device in a shady location.
- Avoid direct sunlight, particularly in warm climatic regions.
- Avoid direct exposure to weather conditions.

Temperature tables

 Observe the interdependencies between the permitted ambient and fluid temperatures when operating the device in hazardous areas.

 For detailed information on the temperature tables, see the separate document entitled "Safety Instructions" (XA) for the device.

System pressure

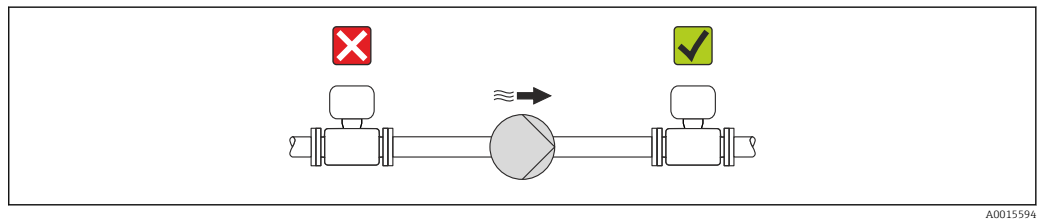

Never install the sensor on the pump suction side in order to avoid the risk of low pressure, and thus damage to the liner.

i Furthermore, install pulse dampers if reciprocating, diaphragm or peristaltic pumps are used.

- i** ■ For information on the liner's resistance to partial vacuum → 128
- For information on the shock resistance of the measuring system → 127
- For information on the vibration resistance of the measuring system → 127

Vibrations

In the event of very strong vibrations, the pipe and sensor must be supported and fixed.

- i** ■ For information on the shock resistance of the measuring system → 127
- For information on the vibration resistance of the measuring system → 127

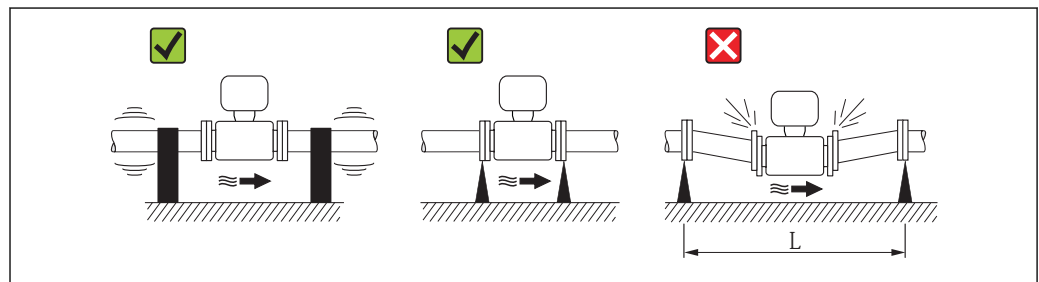

5 Measures to avoid device vibrations ($L > 10\text{ m}$ (33 ft))

Adapters

Suitable adapters to DIN EN 545 (double-flange reducers) can be used to install the sensor in larger-diameter pipes. The resultant increase in the rate of flow improves measuring accuracy with very slow-moving fluids. The nomogram shown here can be used to calculate the pressure loss caused by reducers and expanders.

i The nomogram only applies to liquids with a viscosity similar to that of water.

1. Calculate the ratio of the diameters d/D .
2. From the nomogram read off the pressure loss as a function of flow velocity (downstream from the reduction) and the d/D ratio.

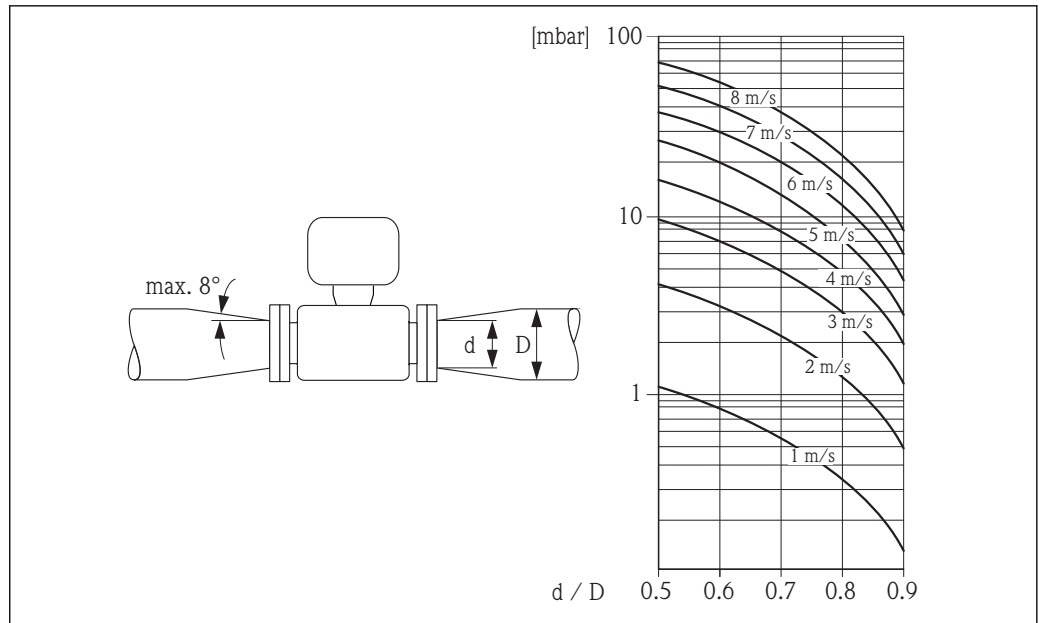

A0016359

6.1.3 Special mounting instructions

Display protection

- To ensure that the optional display protection can be easily opened, maintain the following minimum head clearance: 350 mm (13.8 in)

6.2 Mounting the measuring device

6.2.1 Required tools

For transmitter

- For turning the transmitter housing: Open-ended wrench 8 mm
- For opening the securing clamps: Allen key 3 mm

For sensor

For flanges and other process connections:

- Screws, nuts, seals etc. are not included in the scope of supply and must be provided by the customer.
- Appropriate mounting tools

6.2.2 Preparing the measuring device

1. Remove all remaining transport packaging.
2. Remove any protective covers or protective caps present from the sensor.
3. Remove stick-on label on the electronics compartment cover.

6.2.3 Mounting the sensor

⚠ WARNING

Danger due to improper process sealing!

- ▶ Ensure that the inside diameters of the gaskets are greater than or equal to that of the process connections and piping.
 - ▶ Ensure that the gaskets are clean and undamaged.
 - ▶ Install the gaskets correctly.
1. Ensure that the direction of the arrow on the sensor matches the flow direction of the medium.
 2. To ensure compliance with device specifications, install the measuring device between the pipe flanges in a way that it is centered in the measurement section.
 3. If using ground disks, comply with the Installation Instructions provided.
 4. Observe required screw tightening torques → 24.
 5. Install the measuring device or turn the transmitter housing so that the cable entries do not point upwards.

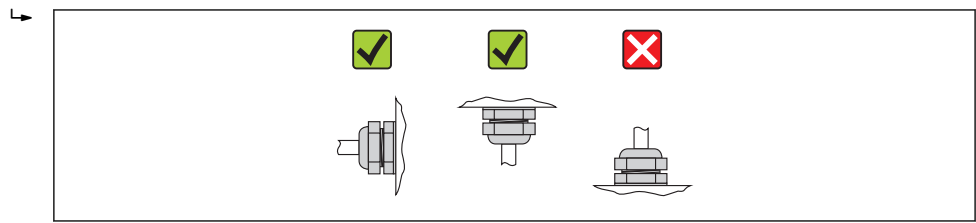

A0013964

Mounting the seals

⚠ CAUTION

An electrically conductive layer could form on the inside of the measuring tube!

Risk of measuring signal short circuit.

- ▶ Do not use electrically conductive sealing compounds such as graphite.

Comply with the following instructions when installing seals:

- Make sure that the seals do not protrude into the piping cross-section.
- For DIN flanges: only use seals according to DIN EN 1514-1.
- For "PFA" lining: generally additional seals are **not** required.
- For "PTFE" lining: generally additional seals are **not** required.

Mounting the ground cable/ground disks

Comply with the information on potential equalization and detailed mounting instructions for the use of ground cables/ground disks → 33.

Screw tightening torques

Please note the following:

- The screw tightening torques listed below apply only to lubricated threads and to pipes not subjected to tensile stress.
- Tighten the screws uniformly and in diagonally opposite sequence.
- Overtightening the screws will deform the sealing faces or damage the seals.

Screw tightening torques for EN 1092-1 (DIN 2501), PN 40/25

Nominal diameter [mm]	Pressure rating [bar]	Threaded fasteners [mm]	Max. screw tightening torque [Nm]	
			PTFE	PFA
15	PN 40	4 × M12	11	–
25	PN 40	4 × M12	26	20

Nominal diameter [mm]	Pressure rating [bar]	Threaded fasteners [mm]	Max. screw tightening torque [Nm]	
			PTFE	PFA
32	PN 40	4 × M16	41	35
40	PN 40	4 × M16	52	47
50	PN 40	4 × M16	65	59
65 ¹⁾	PN 16	8 × M16	43	40
65	PN 40	8 × M16	43	40
80	PN 16	8 × M16	53	48
80	PN 40	8 × M16	53	48
100	PN 16	8 × M16	57	51
100	PN 40	8 × M20	78	70
125	PN 16	8 × M16	75	67
125	PN 40	8 × M24	111	99
150	PN 16	8 × M20	99	85
150	PN 40	8 × M24	136	120
200	PN 10	8 × M20	141	101
200	PN 16	12 × M20	94	67
200	PN 25	12 × M24	138	105
250	PN 10	12 × M20	110	-
250	PN 16	12 × M24	131	-
250	PN 25	12 × M27	200	-
300	PN 10	12 × M20	125	-
300	PN 16	12 × M24	179	-
300	PN 25	16 × M27	204	-
350	PN 10	16 × M20	188	-
350	PN 16	16 × M24	254	-
350	PN 25	16 × M30	380	-
400	PN 10	16 × M24	260	-
400	PN 16	16 × M27	330	-
400	PN 25	16 × M33	488	-
450	PN 10	20 × M24	235	-
450	PN 16	20 × M27	300	-
450	PN 25	20 × M33	385	-
500	PN 10	20 × M24	265	-
500	PN 16	20 × M30	448	-
500	PN 25	20 × M33	533	-
600	PN 10	20 × M27	345	-
600 ¹⁾	PN 16	20 × M33	658	-
600	PN 25	20 × M36	731	-

1) Designed acc. to EN 1092-1 (not to DIN 2501)

Screw tightening torques for ASME B16.5, Class 150/300

Nominal diameter		Pressure rating [psi]	Threaded fasteners [in]	Max. screw tightening torque [Nm] ([lbf · ft])	
[mm]	[in]			PTFE	PFA
15	½	Class 150	4 × ½	6 (4)	- (-)
15	½	Class 300	4 × ½	6 (4)	- (-)
25	1	Class 150	4 × ½	11 (8)	10 (7)
25	1	Class 300	4 × 5/8	14 (10)	12 (9)
40	1 ½	Class 150	4 × ½	24 (18)	21 (15)
40	1 ½	Class 300	4 × ¾	34 (25)	31 (23)
50	2	Class 150	4 × 5/8	47 (35)	44 (32)
50	2	Class 300	8 × 5/8	23 (17)	22 (16)
80	3	Class 150	4 × 5/8	79 (58)	67 (49)
80	3	Class 300	8 × ¾	47 (35)	42 (31)
100	4	Class 150	8 × 5/8	56 (41)	50 (37)
100	4	Class 300	8 × ¾	67 (49)	59 (44)
150	6	Class 150	8 × ¾	106 (78)	86 (63)
150	6	Class 300	12 × ¾	73 (54)	67 (49)
200	8	Class 150	8 × ¾	143 (105)	109 (80)
250	10	Class 150	12 × 7/8	135 (100)	- (-)
300	12	Class 150	12 × 7/8	178 (131)	- (-)
350	14	Class 150	12 × 1	260 (192)	- (-)
400	16	Class 150	16 × 1	246 (181)	- (-)
450	18	Class 150	16 × 1 1/8	371 (274)	- (-)
500	20	Class 150	20 × 1 1/8	341 (252)	- (-)
600	24	Class 150	20 × 1 ¼	477 (352)	- (-)

Screw tightening torques for JIS B2220, 10/20K

Nominal diameter		Pressure rating [bar]	Threaded fasteners [mm]	Max. screw tightening torque [Nm]	
[mm]				PTFE	PFA
25		10K	4 × M16	32	27
25		20K	4 × M16	32	27
32		10K	4 × M16	38	-
32		20K	4 × M16	38	-
40		10K	4 × M16	41	37
40		20K	4 × M16	41	37
50		10K	4 × M16	54	46
50		20K	8 × M16	27	23
65		10K	4 × M16	74	63
65		20K	8 × M16	37	31
80		10K	8 × M16	38	32
80		20K	8 × M20	57	46
100		10K	8 × M16	47	38
100		20K	8 × M20	75	58

Nominal diameter [mm]	Pressure rating [bar]	Threaded fasteners [mm]	Max. screw tightening torque [Nm]	
			PTFE	PFA
125	10K	8 × M20	80	66
125	20K	8 × M22	121	103
150	10K	8 × M20	99	81
150	20K	12 × M22	108	72
200	10K	12 × M20	82	54
200	20K	12 × M22	121	88
250	10K	12 × M22	133	-
250	20K	12 × M24	212	-
300	10K	16 × M22	99	-
300	20K	16 × M24	183	-

Screw tightening torques for AS 2129, Table E

Nominal diameter [mm]	Threaded fasteners [mm]	Max. screw tightening torque [Nm]
		PTFE
25	4 × M12	21
50	4 × M16	42

Screw tightening torques for AS 4087, PN 16

Nominal diameter [mm]	Threaded fasteners [mm]	Max. screw tightening torque [Nm]
		PTFE
50	4 × M16	42

6.2.4 Turning the transmitter housing

To provide easier access to the connection compartment or display module, the transmitter housing can be turned.

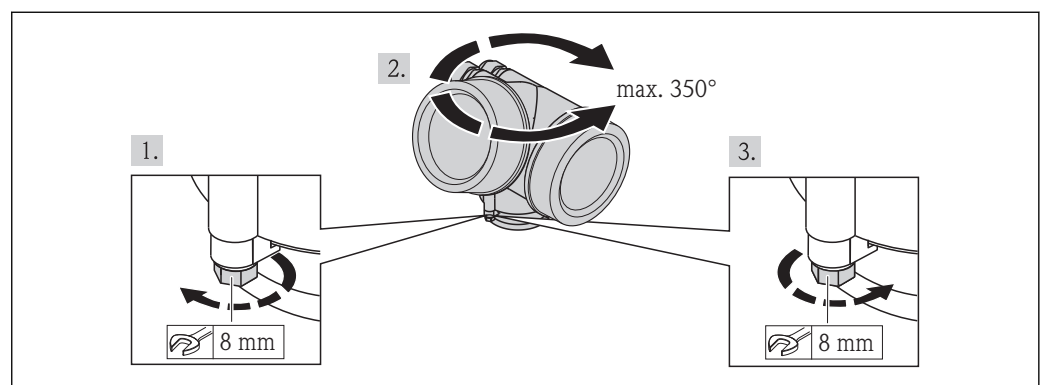

A0013713

1. Release the fixing screw.
2. Turn the housing to the desired position.
3. Firmly tighten the securing screw.

6.2.5 Turning the display module

The display module can be turned to optimize display readability and operability.

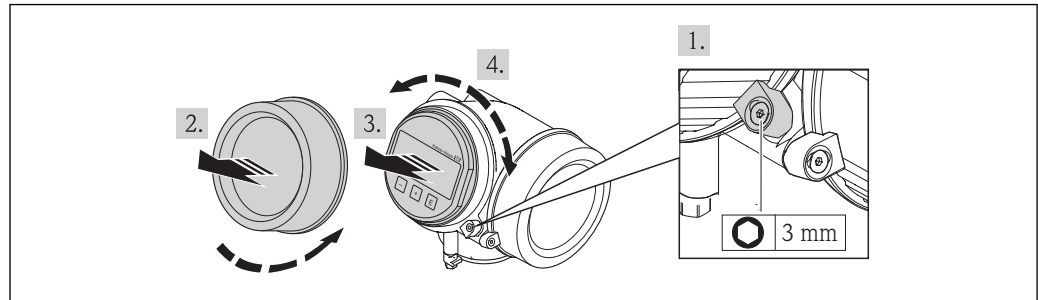

A0013905

1. Loosen the securing clamp of the electronics compartment cover using an Allen key.
2. Unscrew cover of the electronics compartment from the transmitter housing.
3. Optional: pull out the display module with a gentle rotational movement.
4. Rotate the display module into the desired position: Max. $8 \times 45^\circ$ in each direction.
5. Without display module pulled out:
Allow display module to engage at desired position.
6. With display module pulled out:
Feed the cable into the gap between the housing and main electronics module and plug the display module into the electronics compartment until it engages.
7. Reverse the removal procedure to reassemble the transmitter.

6.3 Post-installation check

Is the device undamaged (visual inspection)?	<input type="checkbox"/>
Does the measuring device conform to the measuring point specifications? For example: <ul style="list-style-type: none"> ▪ Process temperature ▪ Process pressure (refer to the section on "Pressure-temperature ratings" in the "Technical Information" document) ▪ Ambient temperature ▪ Measuring range 	<input type="checkbox"/>
Has the correct orientation for the sensor been selected ? <ul style="list-style-type: none"> ▪ According to sensor type ▪ According to medium temperature ▪ According to medium properties (outgassing, with entrained solids) 	<input type="checkbox"/>
Does the arrow on the sensor nameplate match the direction of flow of the fluid through the piping ?	<input type="checkbox"/>
Are the measuring point identification and labeling correct (visual inspection)?	<input type="checkbox"/>
Is the device adequately protected from precipitation and direct sunlight?	<input type="checkbox"/>
Have the fixing screws been tightened with the correct tightening torque?	<input type="checkbox"/>

7 Electrical connection

 The measuring device does not have an internal circuit breaker. For this reason, assign the measuring device a switch or power-circuit breaker so that the power supply line can be easily disconnected from the mains.

7.1 Connection conditions

7.1.1 Required tools

- For cable entries: Use corresponding tools
- For securing clamp: Allen key 3 mm
- Wire stripper
- When using stranded cables: crimping tool for ferrule
- For removing cables from terminal: flat blade screwdriver ≤ 3 mm (0.12 in)

7.1.2 Requirements for connecting cable

The connecting cables provided by the customer must fulfill the following requirements.

Electrical safety

In accordance with applicable federal/national regulations.

Permitted temperature range

- -40 °C (-40 °F) to $+80$ °C ($+176$ °F)
- Minimum requirement: cable temperature range \geq ambient temperature $+20$ K

Signal cable

Current output

For 4-20 mA HART: Shielded cable recommended. Observe grounding concept of the plant.

Pulse/frequency/switch output

Standard installation cable is sufficient.

Cable diameter

- Cable glands supplied:
M20 \times 1.5 with cable ϕ 6 to 12 mm (0.24 to 0.47 in)
- Plug-in spring terminals for device version without integrated overvoltage protection: wire cross-sections 0.5 to 2.5 mm² (20 to 14 AWG)
- Screw terminals for device version with integrated overvoltage protection: wire cross-sections 0.2 to 2.5 mm² (24 to 14 AWG)

7.1.3 Terminal assignment

Transmitter

4-20 mA HART connection version with additional outputs

<p>Maximum number of terminals, without integrated overvoltage protection</p>	<p>Maximum number of terminals, with integrated overvoltage protection</p>
<p>1 Output 1 (passive): supply voltage and signal transmission 2 Output 2 (passive): supply voltage and signal transmission 3 Ground terminal for cable shield</p>	

Order code for "Output"	Terminal numbers			
	Output 1		Output 2	
	1 (+)	2 (-)	3 (+)	4 (-)
Option A	4-20 mA HART (passive)		-	
Option B ¹⁾	4-20 mA HART (passive)		Pulse/frequency/switch output (passive)	

1) Output 1 must always be used; output 2 is optional.

7.1.4 Requirements for the supply unit

Supply voltage

Transmitter

An external power supply is required for each output. The following supply voltage values apply for the 4-20 mA HART current output:

Order code for "Output"	Minimum terminal voltage	Maximum terminal voltage
Option A ^{1) 2)} : 4-20 mA HART	For 4 mA: ≥ DC 18 V For 20 mA: ≥ DC 14 V	DC 35 V
Option B ^{1) 2)} : 4-20 mA HART, pulse/frequency/switch output	For 4 mA: ≥ DC 18 V For 20 mA: ≥ DC 14 V	DC 35 V

1) External supply voltage of the power supply unit with load.

2) For device versions with SD03 local display: The terminal voltage must be increased by DC 2 V if backlighting is used.

Load

Load for current output: 0 to 500 Ω, depending on the external supply voltage of the power supply unit

Calculation of the maximum load

Depending on the supply voltage of the power supply unit (U_S), the maximum load (R_B) including line resistance must be observed to ensure adequate terminal voltage at the device. In doing so, observe the minimum terminal voltage

- For $U_S = 18$ to 18.9 V: $R_B \leq (U_S - 18 \text{ V}): 0.0036 \text{ A}$
- For $U_S = 18.9$ to 24.5 V: $R_B \leq (U_S - 13.5 \text{ V}): 0.022 \text{ A}$
- For $U_S = 24.5$ to 30 V: $R_B \leq 500 \Omega$

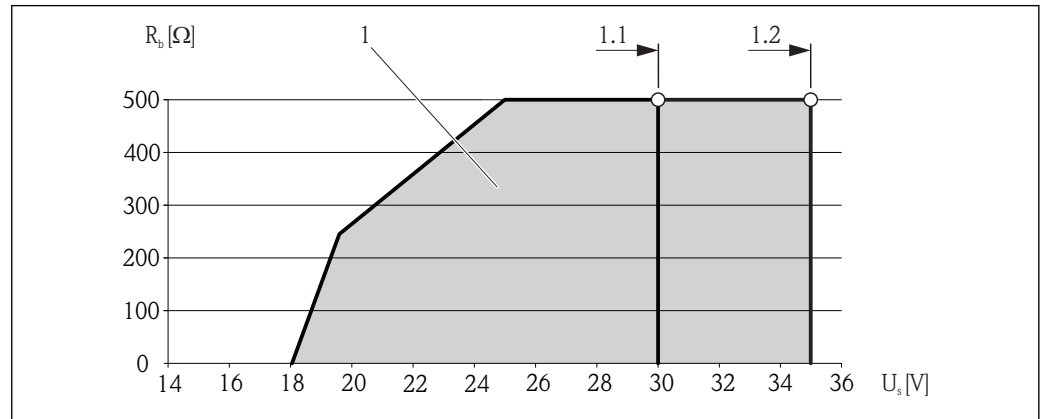

A0013563

1 Operating range

1.1 For order code for "Output", option A "4-20 mA HART"/option B "4-20 mA HART, pulse/frequency/switch output" with Ex i

1.2 For order code for "Output", option A "4-20 mA HART"/option B "4-20 mA HART, pulse/frequency/switch output" with non-Ex and Ex d

Sample calculation

Supply voltage of the power supply unit: $U_S = 19 \text{ V}$

Maximum load: $R_B \leq (19 \text{ V} - 13.5 \text{ V}): 0.022 \text{ A} = 250 \Omega$

7.1.5 Preparing the measuring device

1. Remove dummy plug if present.
2. **NOTICE!** Insufficient sealing of the housing! Operational reliability of the measuring device could be compromised. Use suitable cable glands corresponding to the degree of protection.
If measuring device is delivered without cable glands:
Provide suitable cable gland for corresponding connecting cable .
3. If measuring device is delivered with cable glands:
Observe cable specification .

7.2 Connecting the measuring device

NOTICE

Limitation of electrical safety due to incorrect connection!

- ▶ Have electrical connection work carried out by correspondingly trained specialists only.
- ▶ Observe applicable federal/national installation codes and regulations.
- ▶ Comply with local workplace safety regulations.
- ▶ For use in potentially explosive atmospheres, observe the information in the device-specific Ex documentation.

7.2.1 Connecting the transmitter

Connection via terminals

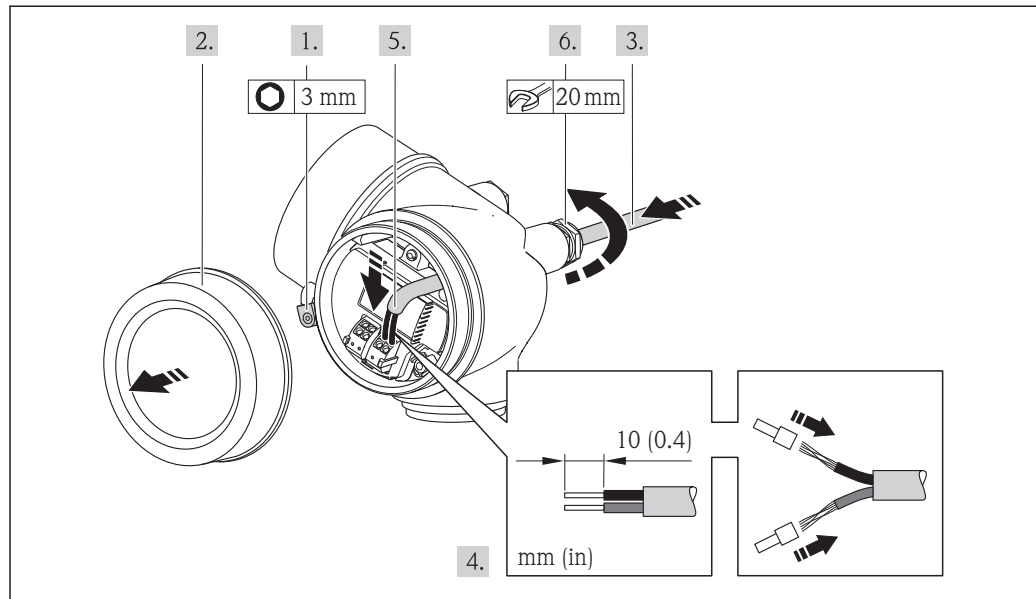

A0013836

1. Loosen the securing clamp of the connection compartment cover.
2. Unscrew the connection compartment cover.
3. Push the cable through the cable entry . To ensure tight sealing, do not remove the sealing ring from the cable entry.
4. Strip the cable and cable ends. In the case of stranded cables, also fit ferrules.
5. Connect the cable in accordance with the terminal assignment . For HART communication: when connecting the cable shielding to the ground terminal, observe the grounding concept of the facility.
6. Firmly tighten the cable glands.
7. **WARNING!** Housing degree of protection may be voided due to insufficient sealing of the housing. Screw in the screw without using any lubricant. The threads on the cover are coated with a dry lubricant.

Reverse the removal procedure to reassemble the transmitter.

Removing a cable

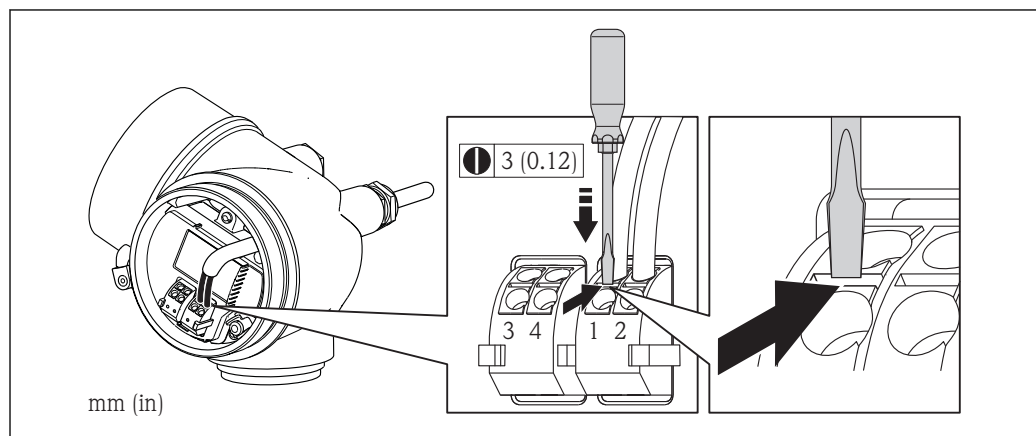

A0013835

- To remove a cable from the terminal, use a flat-blade screwdriver to push the slot between the two terminal holes while simultaneously pulling the cable end out of the terminal.

7.2.2 Ensuring potential equalization

Requirements

CAUTION

Electrode damage can result in the complete failure of the device!

- ▶ Same electrical potential for the fluid and sensor
- ▶ Company-internal grounding concepts
- ▶ Pipe material and grounding

 For devices intended for use in hazardous locations, please observe the guidelines in the Ex documentation (XA).

Connection examples for standard situations

Metal, grounded pipe

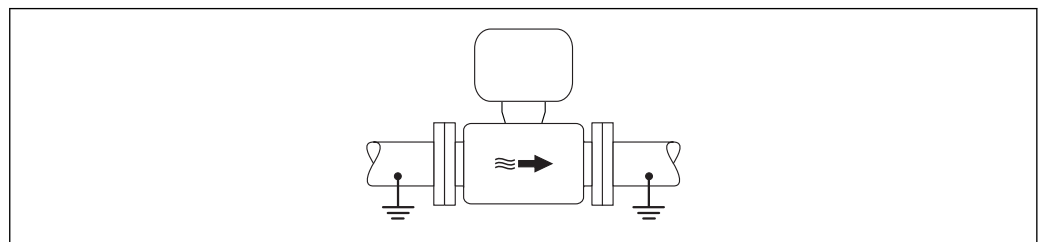

 6 Potential equalization via measuring tube

A0016315

Connection example in special situations

Unlined and ungrounded metal pipe

This connection method also applies in situations where:

- The customary potential equalization is not used
- Equalizing currents are present

Ground cable	Copper wire, at least 6 mm^2 (0.0093 in^2)
---------------------	--

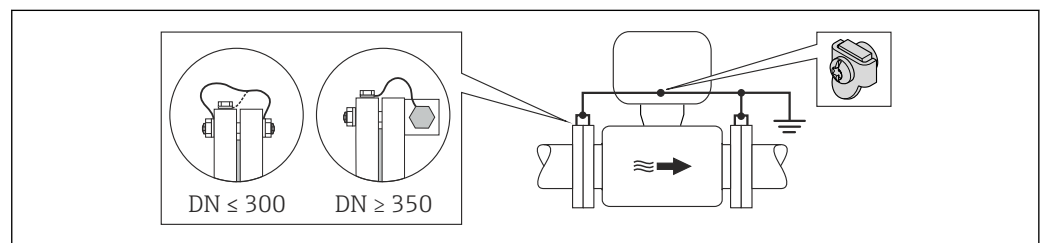

 7 Potential equalization via ground terminal and pipe flanges

A0016317

1. Connect both sensor flanges to the pipe flange via a ground cable and ground them.
2. If $\text{DN} \leq 300$ (12"): Mount the ground cable directly on the conductive flange coating of the sensor with the flange screws. If $\text{DN} \geq 350$ (14"): Mount the ground cable directly on the metal transport bracket. Observe torques →  24.
3. Connect the connection housing of the transmitter or sensor to ground potential by means of the ground terminal provided for the purpose.

Plastic pipe or pipe with insulating liner

This connection method also applies in situations where:

- The customary potential equalization is not used
- Equalizing currents are present

Ground cable	Copper wire, at least 6 mm^2 (0.0093 in^2)
---------------------	--

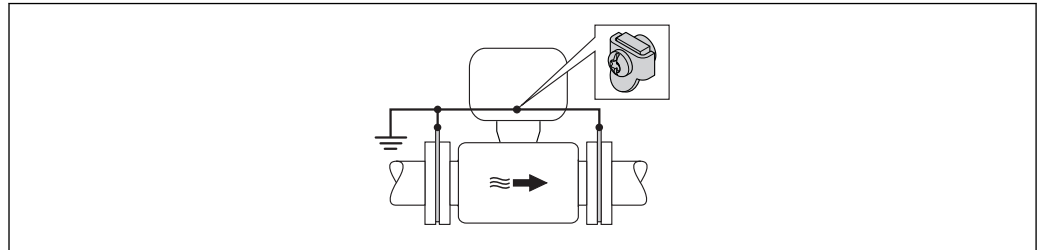

A0016318

8 Potential equalization via ground terminal and ground disks

1. Connect the ground disks to the ground terminal via the ground cable.
2. Connect the ground disks to ground potential.

Pipe with a cathodic protection unit

This connection method is only used if the following two conditions are met:

- Metal pipe without liner or pipe with electrically conductive liner
- Cathodic protection is integrated in the personal protection equipment

Ground cable	Copper wire, at least 6 mm^2 (0.0093 in^2)
---------------------	--

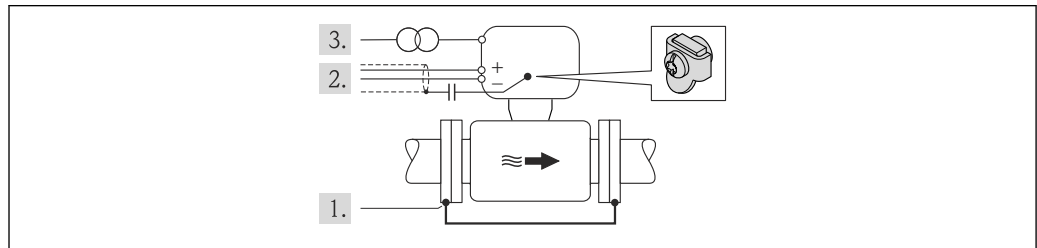

A0016319

Prerequisite: The sensor is installed in the pipe in a way that provides electrical insulation.

1. Connect the two flanges of the pipe to one another via a ground cable.
2. Guide the shield of the signal lines through a capacitor.
3. Connect the measuring device to the power supply such that it is floating in relation to the protective ground (isolation transformer).

7.3 Special connection instructions

7.3.1 Connection examples

Current output 4-20 mA HART

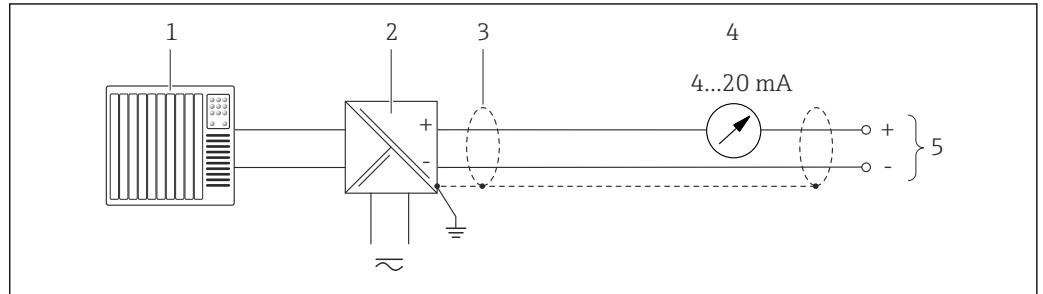

A0015511

9 Connection example for 4-20 mA HART current output (passive)

- 1 Automation system with current input (e.g. PLC)
- 2 Active barrier for power supply with integrated resistor for HART communication ($\geq 250 \Omega$) (e.g. RN221N)
Connection for HART operating devices → 134
Observe the maximum load → 30
- 3 Cable shield, observe cable specifications
- 4 Analog display unit: observe maximum load → 30
- 5 Transmitter

Pulse/frequency output

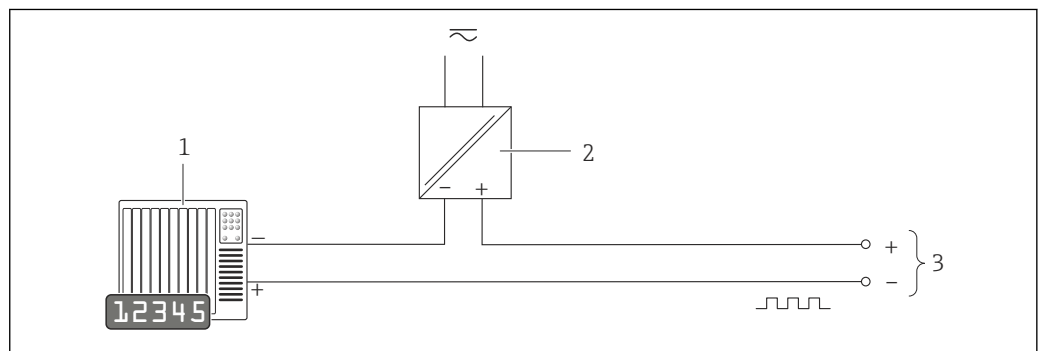

A0016801

10 Connection example for pulse/frequency output (passive)

- 1 Automation system with pulse/frequency input (e.g. PLC)
- 2 Power supply
- 3 Transmitter: observe input values

Switch output

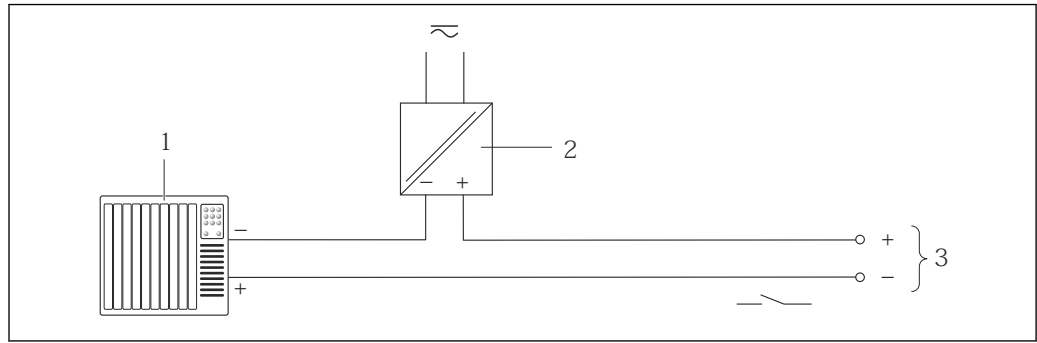

A0016802

11 Connection example for switch output (passive)

- 1 Automation system with switch input (e.g. PLC)
- 2 Power supply
- 3 Transmitter: observe input values

HART input

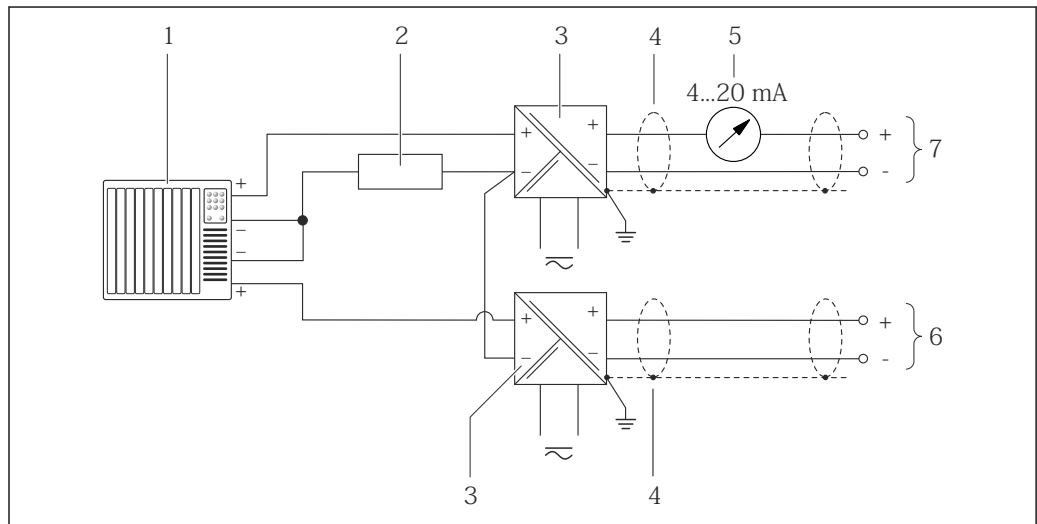

A0016029

12 Connection example for HART input with a common negative

- 1 Automation system with HART output (e.g. PLC)
- 2 Resistor for HART communication ($\geq 250 \Omega$): observe maximum load \rightarrow 31
- 3 Active barrier for power supply (e.g. RN221N)
- 4 Cable shield, observe cable specifications
- 5 Analog display unit: observe maximum load \rightarrow 31
- 6 Pressure transmitter (e.g. Cerabar M, Cerabar S): see requirements
- 7 Transmitter

7.4 Ensuring the degree of protection

The measuring device fulfills all the requirements for the IP66/67 degree of protection, Type 4X enclosure.

To guarantee IP66/67 degree of protection, Type 4X enclosure, carry out the following steps after the electrical connection:

1. Check that the housing seals are clean and fitted correctly. Dry, clean or replace the seals if necessary.
2. Tighten all housing screws and screw covers.
3. Firmly tighten the cable glands.

4. To ensure that moisture does not enter the cable entry, route the cable so that it loops down before the cable entry ("water trap").

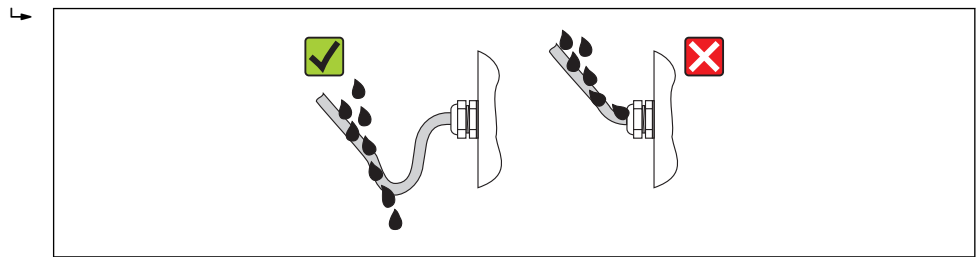

A0013960

5. Insert dummy plugs into unused cable entries.

7.5 Post-connection check

Are cables or the device undamaged (visual inspection)?	<input type="checkbox"/>
Do the cables comply with the requirements ?	<input type="checkbox"/>
Do the cables have adequate strain relief?	<input type="checkbox"/>
Are all the cable glands installed, firmly tightened and leak-tight? Cable run with "water trap" → 36 ?	<input type="checkbox"/>
Depending on the device version: are all the device plugs firmly tightened ?	<input type="checkbox"/>
Does the supply voltage match the specifications on the transmitter nameplate ?	<input type="checkbox"/>
Is the terminal assignment correct ?	<input type="checkbox"/>
If supply voltage is present, do values appear on the display module?	<input type="checkbox"/>
Is the potential equalization established correctly → 33?	<input type="checkbox"/>
Are all housing covers installed and firmly tightened?	<input type="checkbox"/>
Is the securing clamp tightened correctly?	<input type="checkbox"/>

8 Operation options

8.1 Overview of operation options

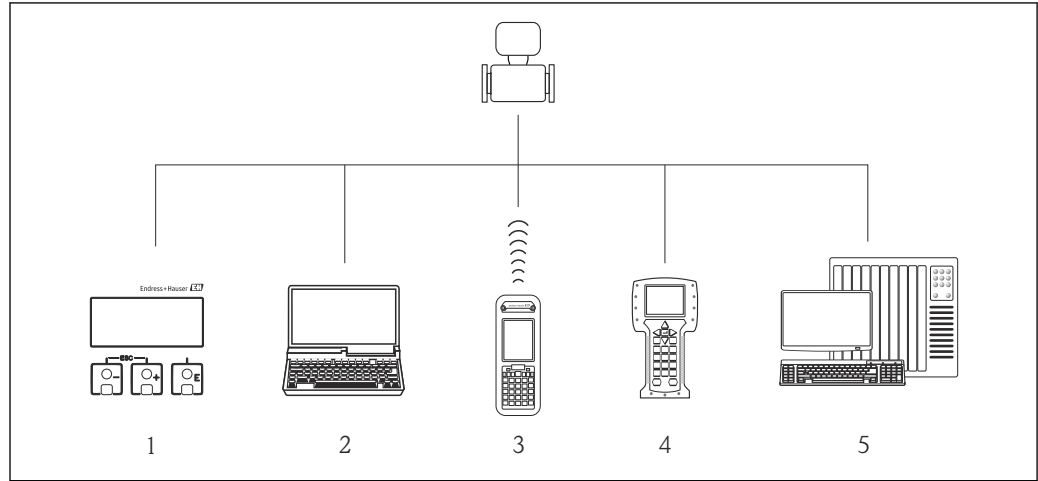

A0015607

- 1 Local operation via display module
- 2 Computer with operating tool (e.g. FieldCare, AMS Device Manager, SIMATIC PDM)
- 3 Field Xpert SFX350 or SFX370
- 4 Field Communicator 475
- 5 Control system (e.g. PLC)

8.2 Structure and function of the operating menu

8.2.1 Structure of the operating menu

 For an overview of the operating menu with menus and parameters

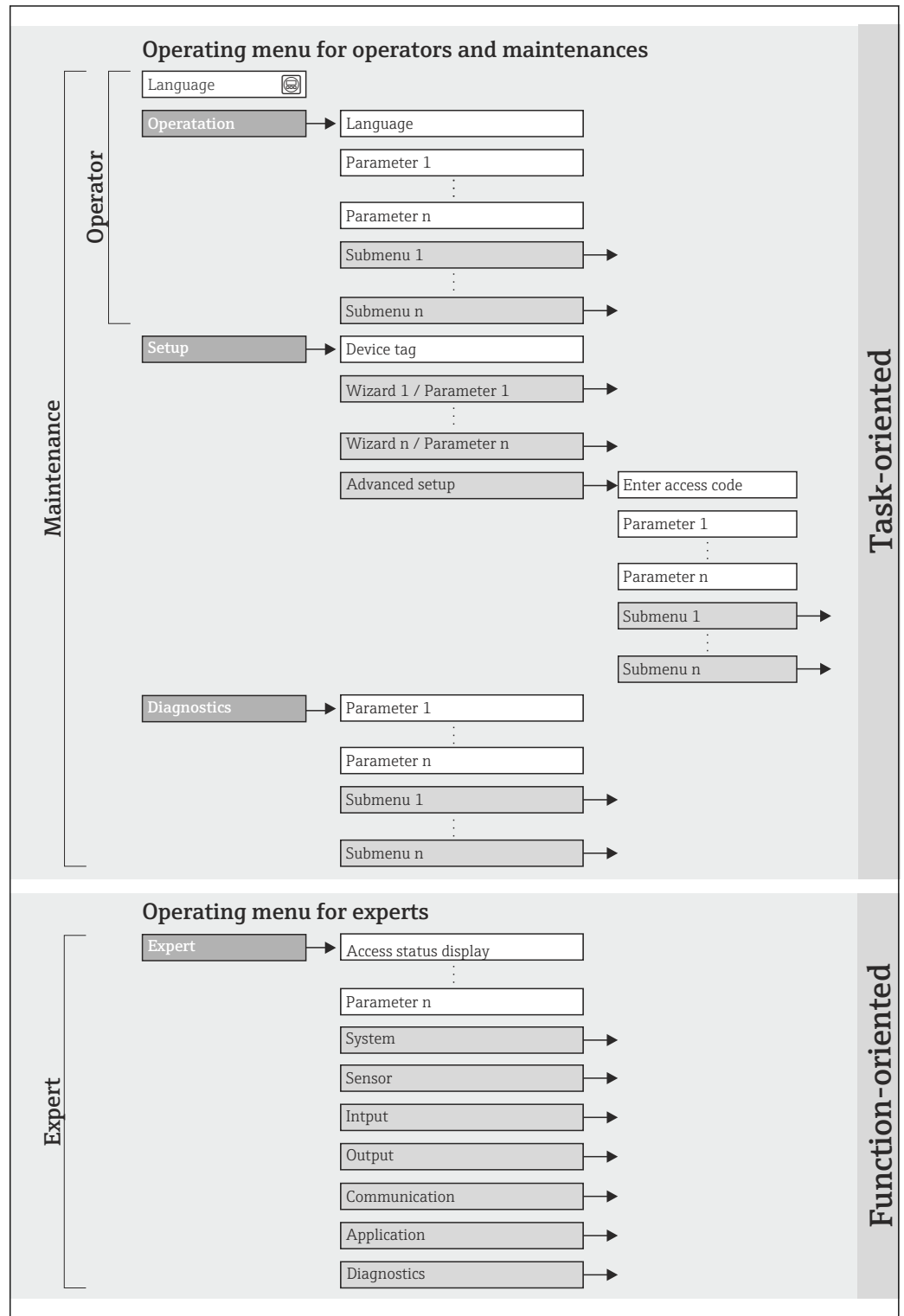

 13 Schematic structure of the operating menu

A0018237-EN

8.2.2 Operating philosophy

The individual parts of the operating menu are assigned to certain user roles (operator, maintenance etc.). Each user role contains typical tasks within the device lifecycle.

Menu		User role and tasks	Content/meaning
Language	task-oriented	Role "Operator", "Maintenance" Tasks during operation: <ul style="list-style-type: none"> ▪ Configuring the operational display ▪ Reading measured values 	Defining the operating language <ul style="list-style-type: none"> ▪ Configuring the operational display (e.g. display format, display contrast) ▪ Resetting and controlling totalizers
Operation			
Setup		"Maintenance" role Commissioning: <ul style="list-style-type: none"> ▪ Configuration of the measurement ▪ Configuration of the inputs and outputs 	Wizards for fast commissioning: <ul style="list-style-type: none"> ▪ Configuring the outputs ▪ Configuring the operational display ▪ Defining the output conditioning ▪ Empty pipe detection ▪ Configuring the low flow cut off "Advanced setup" submenu: <ul style="list-style-type: none"> ▪ For more customized configuration of the measurement (adaptation to special measuring conditions) ▪ Configuration of totalizers ▪ Configuration of electrode cleaning (optional) ▪ Administration (define access code, reset measuring device)
Diagnostics		"Maintenance" role Fault elimination: <ul style="list-style-type: none"> ▪ Diagnostics and elimination of process and device errors ▪ Measured value simulation 	Contains all parameters for error detection and analyzing process and device errors: <ul style="list-style-type: none"> ▪ "Diagnostic list" submenu Contains up to 5 currently pending diagnostic messages. ▪ "Event logbook" submenu Contains up to 20 or 100 (order option "Extended HistoROM") event messages that have occurred. ▪ "Device information" submenu Contains information for identifying the device. ▪ "Measured values" submenu Contains all current measured values. ▪ "Data logging" submenu (order option "Extended HistoROM") Storage and visualization of up to 1000 measured values ▪ "Heartbeat Technology" submenu The functionality of the device is checked on demand and the verification results are documented. ▪ "Simulation" submenu Is used to simulate measured values or output values.
Expert	function-oriented	Tasks that require detailed knowledge of the function of the device: <ul style="list-style-type: none"> ▪ Commissioning measurements under difficult conditions ▪ Optimal adaptation of the measurement to difficult conditions ▪ Detailed configuration of the communication interface ▪ Error diagnostics in difficult cases 	Contains all the parameters of the device and makes it possible to access these parameters directly using an access code. The structure of this menu is based on the function blocks of the device: <ul style="list-style-type: none"> ▪ "System" submenu Contains all higher-order device parameters that do not pertain either to measurement or the measured value communication. ▪ "Sensor" submenu Configuration of the measurement. ▪ "Input" submenu Configuration of the input. ▪ "Output" submenu Configuration of the outputs. ▪ "Communication" submenu Configuration of the digital communication interface. ▪ "Application" submenu Configuration of the functions that go beyond the actual measurement (e.g. totalizer). ▪ "Diagnostics" submenu Error detection and analysis of process and device errors and for device simulation and Heartbeat Technology.

8.3 Access to the operating menu via the local display

8.3.1 Operational display

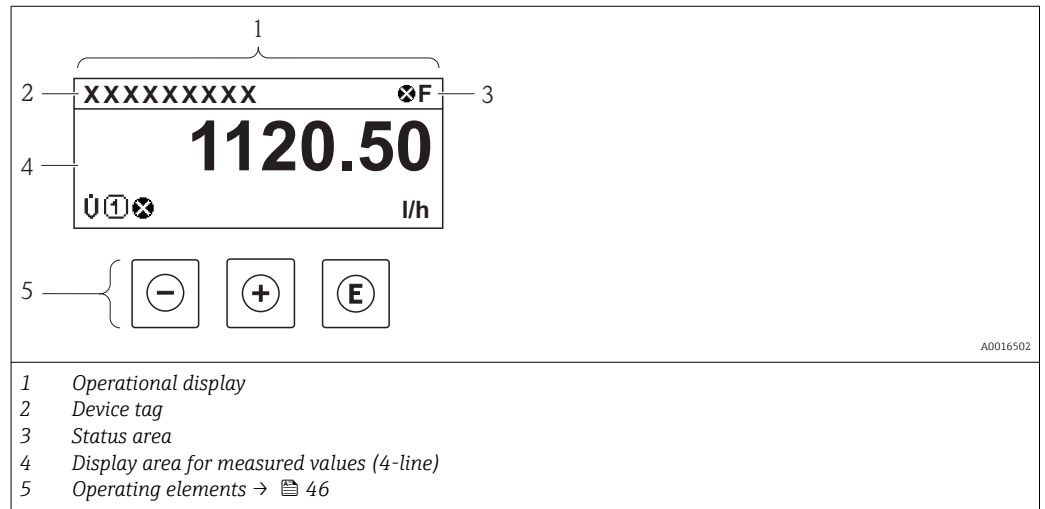

Status area

The following symbols appear in the status area of the operational display at the top right:

- Status signals → 99
 - **F**: Failure
 - **C**: Function check
 - **S**: Out of specification
 - **M**: Maintenance required
- Diagnostic behavior → 100
 - ⊗: Alarm
 - ⚠: Warning
- ⊔: Locking (the device is locked via the hardware)
- ↔: Communication (communication via remote operation is active)

Display area

In the display area, each measured value is prefaced by certain symbol types for further description:

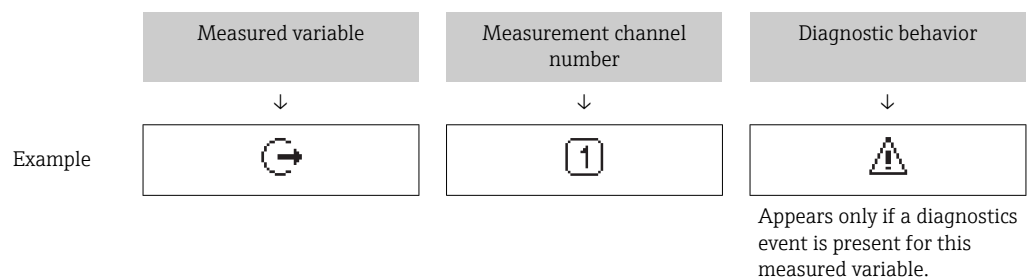

Measured variables

Symbol	Meaning
U	Volume flow
m	Mass flow

	<p>Totalizer</p> <p> The measurement channel number indicates which of the three totalizers is displayed.</p>
	<p>Output</p> <p> The measurement channel number indicates which of the two current outputs is displayed.</p>

Measurement channel numbers

Symbol	Meaning
	Measurement channel 1 to 4

The measurement channel number is displayed only if more than one channel is present for the same measured variable type (e.g. totalizer 1-3).

Diagnostic behavior

The diagnostic behavior pertains to a diagnostic event that is relevant to the displayed measured variable. For information on the symbols → 100

The number and display format of the measured values can be configured via the **"Format display" parameter** → 73. "Operation" menu → Display → Format display



8.3.2 Navigation view

In the submenu	In the wizard
<p>1 Navigation view</p> <p>2 Navigation path to current position</p> <p>3 Status area</p> <p>4 Display area for navigation</p> <p>5 Operating elements → 46</p>	

Navigation path

The navigation path - displayed at the top left in the navigation view - consists of the following elements:



	<ul style="list-style-type: none"> In the submenu: Display symbol for menu In the wizard: Display symbol for wizard 	Omission symbol for operating menu levels in between	Name of current <ul style="list-style-type: none"> Submenu Wizard Parameter
	↓	↓	↓
Examples		/ .. /	Display
		/ .. /	Display

 For more information about the menu icons, refer to the "Display area" section
 →  43

Status area





The following appears in the status area of the navigation view in the top right corner:

- Of the submenu
 - The direct access code for the parameter you are navigating to (e.g. 0022-1)
 - If a diagnostic event is present, the diagnostic behavior and status signal
- In the wizard
 - If a diagnostic event is present, the diagnostic behavior and status signal





-  ▪ For information on the diagnostic behavior and status signal →  99
- For information on the function and entry of the direct access code →  48

Display area

Menus

Symbol	Meaning
	Operation Appears: <ul style="list-style-type: none"> ▪ In the menu next to the "Operation" selection ▪ At the left in the navigation path in the "Operation" menu
	Setup Appears: <ul style="list-style-type: none"> ▪ In the menu next to the "Setup" selection ▪ At the left in the navigation path in the "Setup" menu
	Diagnostics Appears: <ul style="list-style-type: none"> ▪ In the menu next to the "Diagnostics" selection ▪ At the left in the navigation path in the "Diagnostics" menu
	Expert Appears: <ul style="list-style-type: none"> ▪ In the menu next to the "Expert" selection ▪ At the left in the navigation path in the "Expert" menu



Submenus, wizards, parameters

Symbol	Meaning
	Submenu
	Wizard
	Parameters within a wizard  No display symbol exists for parameters in submenus.

Locking

Symbol	Meaning
	Parameter locked When displayed in front of a parameter name, indicates that the parameter is locked. <ul style="list-style-type: none"> ▪ By a user-specific access code ▪ By the hardware write protection switch

Wizard operation

Symbol	Meaning
	Switches to the previous parameter.
	Confirms the parameter value and switches to the next parameter.
	Opens the editing view of the parameter.



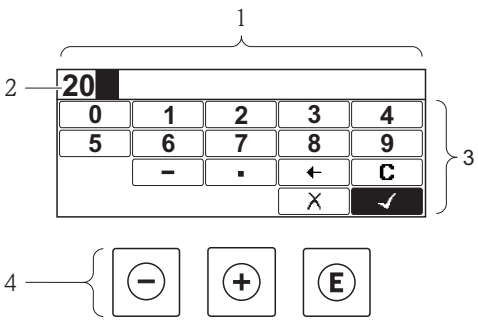
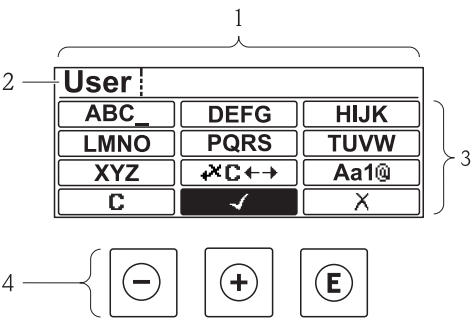



8.3.3 Editing view

Numeric editor	Text editor
	
A0013941	A0013999
<p>1 Editing view 2 Display area of the entered values 3 Input mask 4 Operating elements → 46</p>	

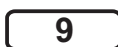









Input mask

The following input symbols are available in the input mask of the numeric and text editor:





Numeric editor

Symbol	Meaning
	Selection of numbers from 0 to 9.
	
	Inserts decimal separator at the input position.
	Inserts minus sign at the input position.
	Confirms selection.
	Moves the input position one position to the left.
	Exits the input without applying the changes.
	Clears all entered characters.







Text editor

Symbol	Meaning
	Toggle <ul style="list-style-type: none"> Between upper-case and lower-case letters For entering numbers For entering special characters
 ... 	Selection of letters from A to Z.
 ... 	Selection of letters from a to z.
 ... 	Selection of special characters.
	Confirms selection.
	Switches to the selection of the correction tools.
	Exits the input without applying the changes.
	Clears all entered characters.

Correction symbols under 

Symbol	Meaning
	Clears all entered characters.
	Moves the input position one position to the right.
	Moves the input position one position to the left.
	Deletes one character immediately to the left of the input position.

8.3.4 Operating elements

Key	Meaning
	<p>Minus key</p> <p><i>In a menu, submenu</i> Moves the selection bar upwards in a choose list.</p> <p><i>With a Wizard</i> Confirms the parameter value and goes to the previous parameter.</p> <p><i>With a text and numeric editor</i> In the input mask, moves the selection bar to the left (backwards).</p>
	<p>Plus key</p> <p><i>In a menu, submenu</i> Moves the selection bar downwards in a choose list.</p> <p><i>With a Wizard</i> Confirms the parameter value and goes to the next parameter.</p> <p><i>With a text and numeric editor</i> Moves the selection bar to the right (forwards) in an input screen.</p>
	<p>Enter key</p> <p><i>For operational display</i></p> <ul style="list-style-type: none"> ▪ Pressing the key briefly opens the operating menu. ▪ Pressing the key for 2 s opens the context menu. <p><i>In a menu, submenu</i></p> <ul style="list-style-type: none"> ▪ Pressing the key briefly: <ul style="list-style-type: none"> - Opens the selected menu, submenu or parameter. - Starts the wizard. - If help text is open, closes the help text of the parameter. ▪ Pressing the key for 2 s for parameter: <ul style="list-style-type: none"> - If present, opens the help text for the function of the parameter. <p><i>With a Wizard</i> Opens the editing view of the parameter.</p> <p><i>With a text and numeric editor</i></p> <ul style="list-style-type: none"> ▪ Pressing the key briefly: <ul style="list-style-type: none"> - Opens the selected group. - Carries out the selected action. ▪ Pressing the key for 2 s confirms the edited parameter value.
	<p>Escape key combination (press keys simultaneously)</p> <p><i>In a menu, submenu</i></p> <ul style="list-style-type: none"> ▪ Pressing the key briefly: <ul style="list-style-type: none"> - Exits the current menu level and takes you to the next higher level. - If help text is open, closes the help text of the parameter. ▪ Pressing the key for 2 s returns you to the operational display ("home position"). <p><i>With a Wizard</i> Exits the wizard and takes you to the next higher level.</p> <p><i>With a text and numeric editor</i> Closes the text or numeric editor without applying changes.</p>
	<p>Minus/Enter key combination (press the keys simultaneously)</p> <p>Reduces the contrast (brighter setting).</p>
	<p>Plus/Enter key combination (press and hold down the keys simultaneously)</p> <p>Increases the contrast (darker setting).</p>
	<p>Minus/Plus/Enter key combination (press the keys simultaneously)</p> <p><i>For operational display</i> Enables or disables the keypad lock (only SD02 display module).</p>

8.3.5 Opening the context menu

Using the context menu, the user can call up the following menus quickly and directly from the operational display:

- Setup
- Conf. backup disp.
- Simulation



Calling up and closing the context menu

The user is in the operational display.

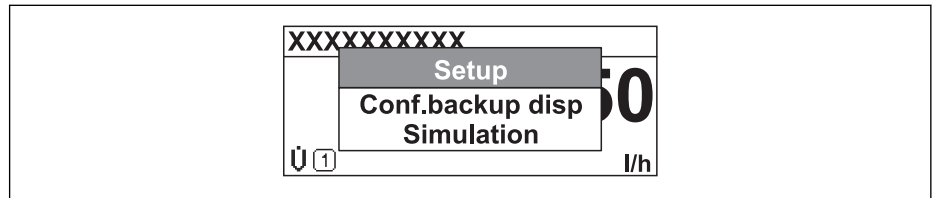

1. Press  for 2 s.
 - ↳ The context menu opens.



A0016326-EN

2. Press  +  simultaneously.
 - ↳ The context menu is closed and the operational display appears.

Calling up the menu via the context menu

1. Open the context menu.
2. Press  to navigate to the desired menu.
3. Press  to confirm the selection.
 - ↳ The selected menu opens.

8.3.6 Navigating and selecting from list

Different operating elements are used to navigate through the operating menu. The navigation path is displayed on the left in the header. Icons are displayed in front of the individual menus. These icons are also shown in the header during navigation.

i For an explanation of the navigation view with symbols and operating elements → 42

Example: Setting the number of displayed measured values to "2 values"

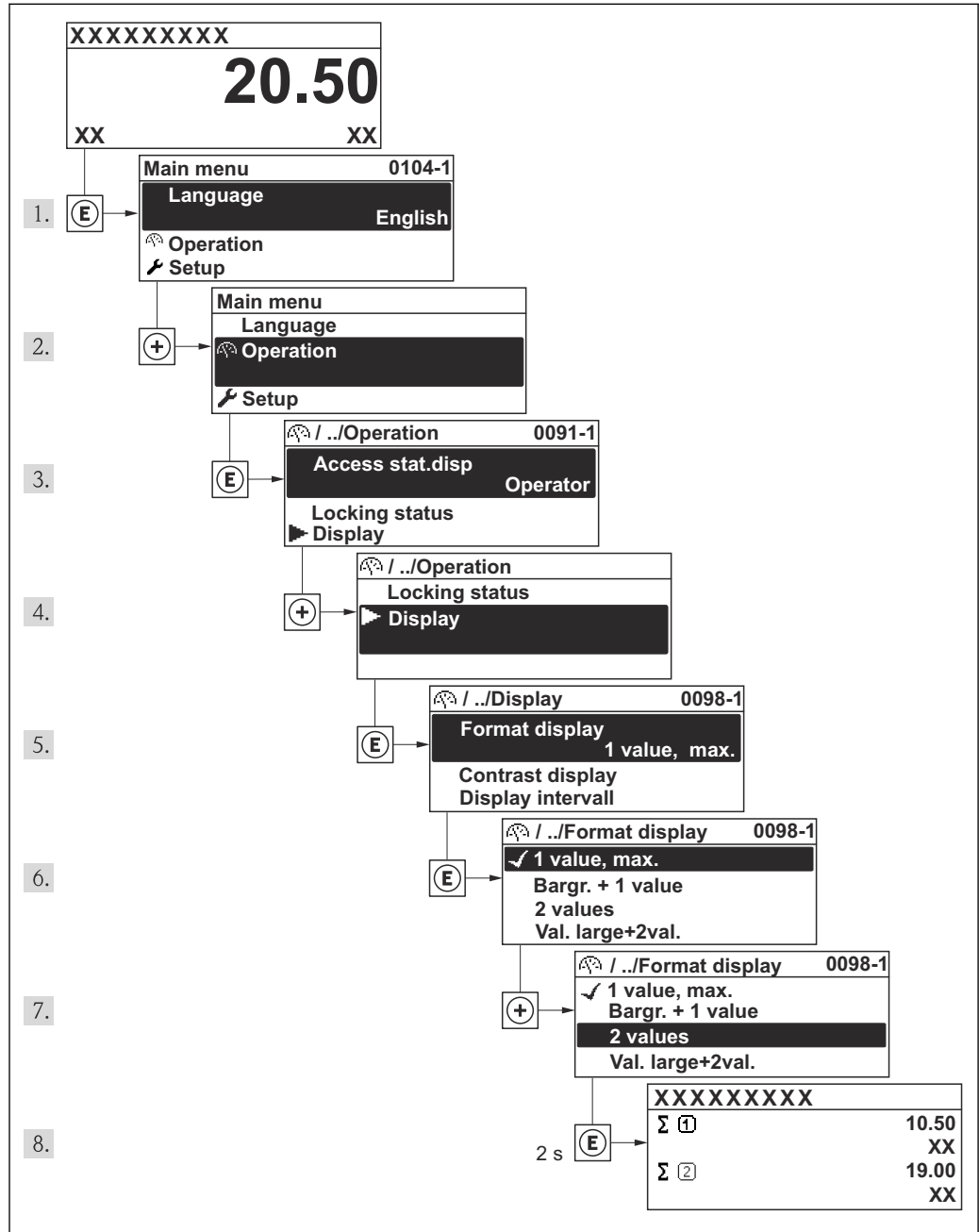

A0014010-EN

8.3.7 Calling the parameter directly

A parameter number is assigned to every parameter to be able to access a parameter directly via the onsite display. Entering this access code in the **Direct access** parameter calls up the desired parameter directly.

Navigation path

"Expert" menu → Direct access

The direct access code consists of a 4-digit number and the channel number, which identifies the channel of a process variable: e.g. 0914-1. In the navigation view, this appears on the right-hand side in the header of the selected parameter.

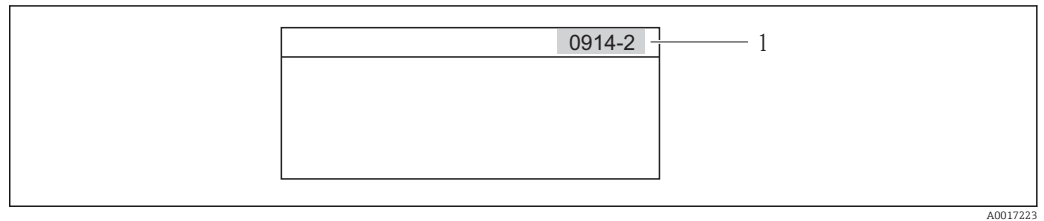

A0017223

1 Direct access code

Note the following when entering the direct access code:

- The leading zeros in the direct access code do not have to be entered.
Example: Input of "914" instead of "0914"
- If no channel number is entered, channel 1 is jumped to automatically.
Example: Input of "0914" → Parameter **Totalizer 1**
- If a different channel is jumped to: Enter the direct access code with the corresponding channel number.
Example: Input of "0914-2" → Parameter **Totalizer 2**



For the direct access codes of the individual parameters

8.3.8 Calling up help text

For some parameters, help texts exist, which the user can call up from the navigation view. These briefly describe the function of the parameter and thus support fast and reliable commissioning.

Calling up and closing the help text

The user is in the navigation view and the selection bar is on a parameter.

1. Press  for 2 s.

↳ The help text for the selected parameter opens.

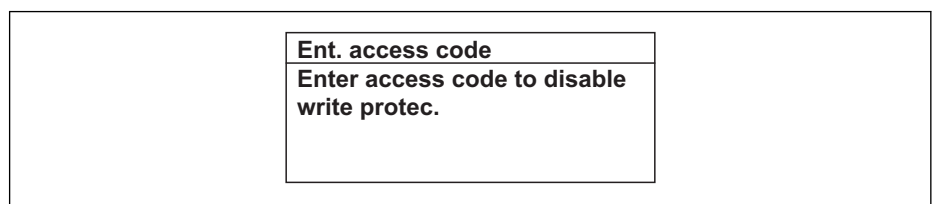

A0014002-EN

 14 Example: Help text for parameter "Enter access code"

2. Press  +  simultaneously.

↳ The help text is closed.

8.3.9 Changing the parameters

i For a description of the editing display - consisting of text editor and numeric editor - with symbols → 44, for a description of the operating elements → 46

Example: Changing the tag name in the "Tag description" parameter from 001-FT-101 to 001-FT-102

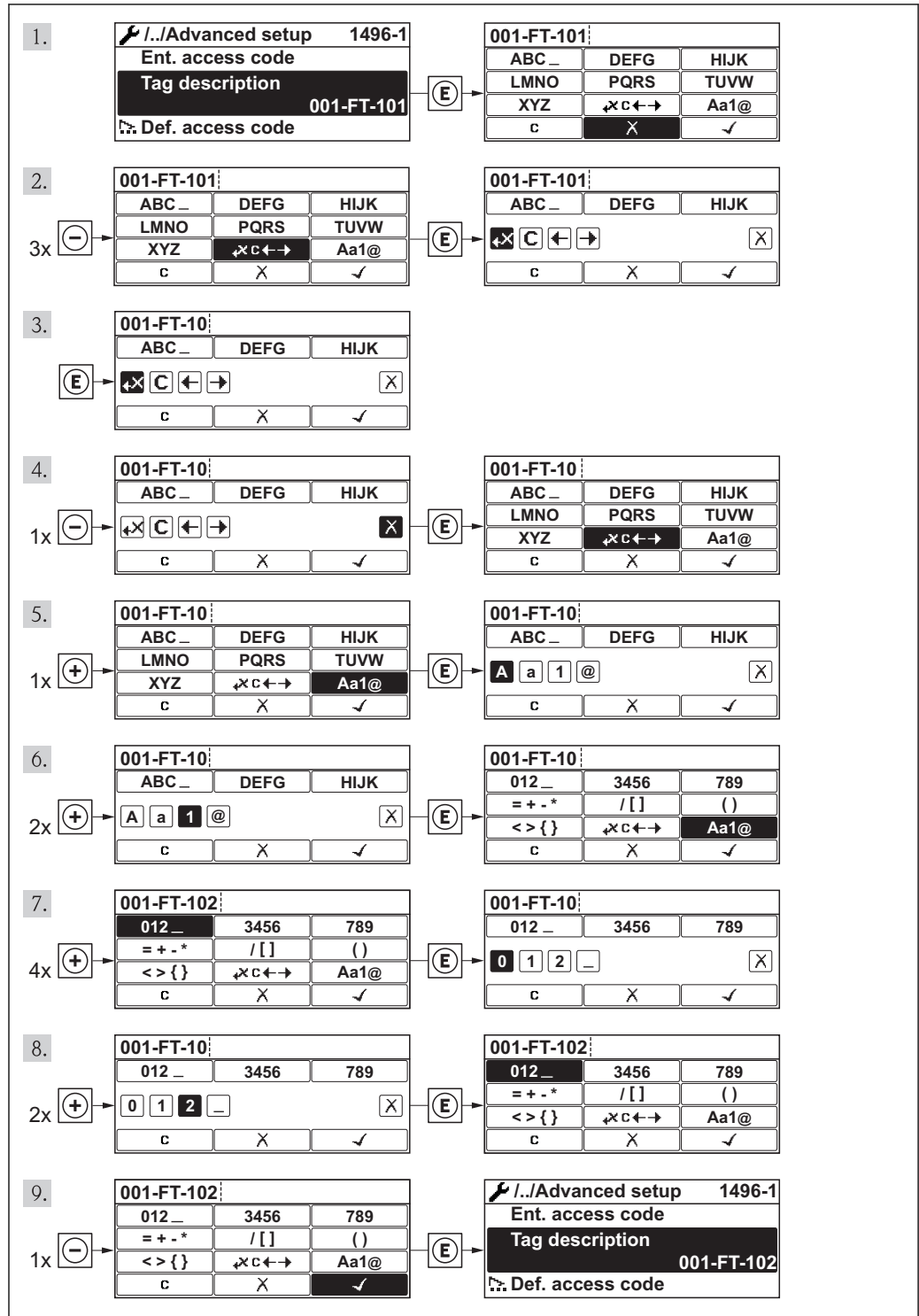

A0014020-EN

A message is displayed if the value entered is outside the permitted value range.

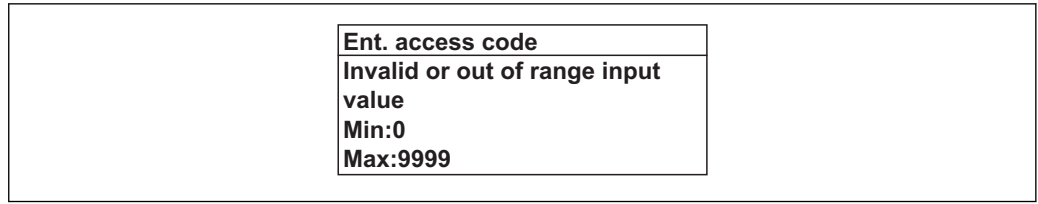

A0014049-EN

8.3.10 User roles and related access authorization

The two user roles "Operator" and "Maintenance" have different write access to the parameters if the customer defines a user-specific access code. This protects the device configuration via the local display from unauthorized access .

Access authorization to parameters

User role	Read access		Write access	
	Without access code (from the factory)	With access code	Without access code (from the factory)	With access code
Operator	✓	✓	✓	-- 1)
Maintenance	✓	✓	✓	✓

- 1) Despite the defined access code, certain parameters can always be modified and thus are excepted from the write protection, as they do not affect the measurement. Refer to the "Write protection via access code" section



If an incorrect access code is entered, the user obtains the access rights of the "Operator" role.

 The user role with which the user is currently logged on is indicated by the **Access status display** parameter. Navigation path: Operation → Access status display

8.3.11 Disabling write protection via access code

If the -symbol appears on the local display in front of a parameter, the parameter is write-protected by a user-specific access code and its value cannot be changed at the moment using the local display .

The locking of the write access via local operation can be disabled by entering the customer-defined access code via the respective access option.

1. After you press , the input prompt for the access code appears.
2. Enter the access code.
 - ↳ The -symbol in front of the parameters disappears; all previously write-protected parameters are now re-enabled.

8.3.12 Enabling and disabling the keypad lock



The keypad lock makes it possible to block access to the entire operating menu via local operation. As a result, it is no longer possible to navigate through the operating menu or change the values of individual parameters. Users can only read the measured values on the operational display.

Local operation with mechanical push buttons (display module SD02)

 Display module SD02: order characteristic "Display; Operation", option C



The keypad lock is switched on and off in the same way:

Switching on the keypad lock

- ▶ The device is in the measured value display.
Press the  +  +  keys simultaneously.
 - ↳ The message **Keylock on** appears on the display: The keypad lock is switched on.

 If the user attempts to access the operating menu while the keypad lock is active, the message **Keylock on** appears.

Switching off the keypad lock

- ▶ The keypad lock is switched on.
Press the  +  +  keys simultaneously.
 - ↳ The message **Keylock off** appears on the display: The keypad lock is switched off.

Local operation with touch control (display module SD03)

 Display module SD03: Order characteristic "Display; Operation", option **E**

The keypad lock is switched on and off via the context menu.

Switching on the keypad lock

The keypad lock is switched on automatically:

- Each time the device is restarted.
- If the device has not been operated for longer than one minute in the measured value display.

1. The device is in the measured value display.
Press the  key for longer than 2 seconds.
 - ↳ A context menu appears.
2. In the context menu, select the **Keylock on** option.
 - ↳ The keypad lock is switched on.

 If the user attempts to access the operating menu while the keypad lock is active, the message **Keylock on** appears.

Switching off the keypad lock

1. The keypad lock is switched on.
Press the  key for longer than 2 seconds.
 - ↳ A context menu appears.
2. In the context menu, select the **Keylock off** option.
 - ↳ The keypad lock is switched off.

8.4 Access to the operating menu via the operating tool

The structure of the operating menu in the operating tools is the same as for operation via the local display.

8.4.1 Connecting the operating tool

Via HART protocol

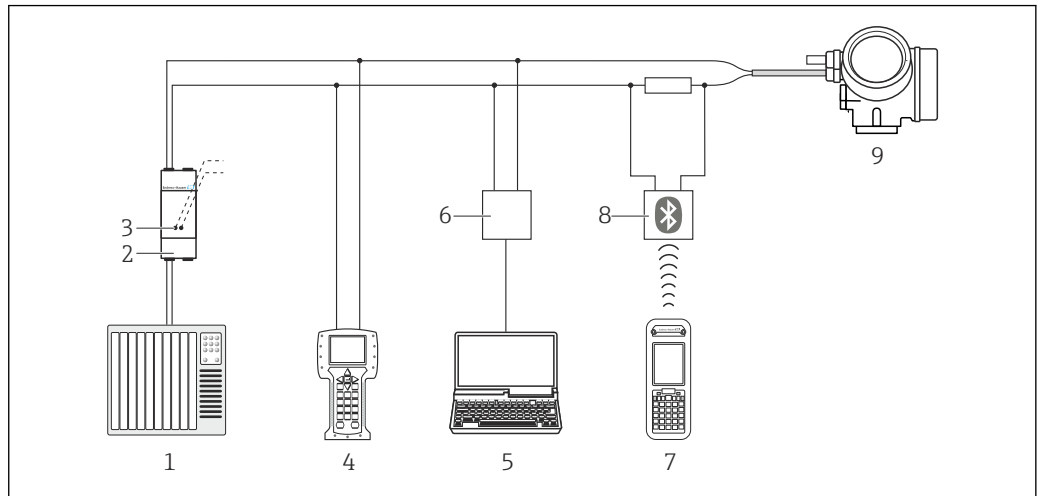

A0013764

15 Options for remote operation via HART protocol

- 1 Control system (e.g. PLC)
- 2 Transmitter power supply unit, e.g. RN221N (with communication resistor)
- 3 Connection for Commubox FXA195 and Field Communicator 475
- 4 Field Communicator 475
- 5 Computer with operating tool (e.g. FieldCare, AMS Device Manager, SIMATIC PDM)
- 6 Commubox FXA195 (USB)
- 7 Field Xpert SFX350 or SFX370
- 8 VIATOR Bluetooth modem with connecting cable
- 9 Transmitter

Via service interface (CDI)

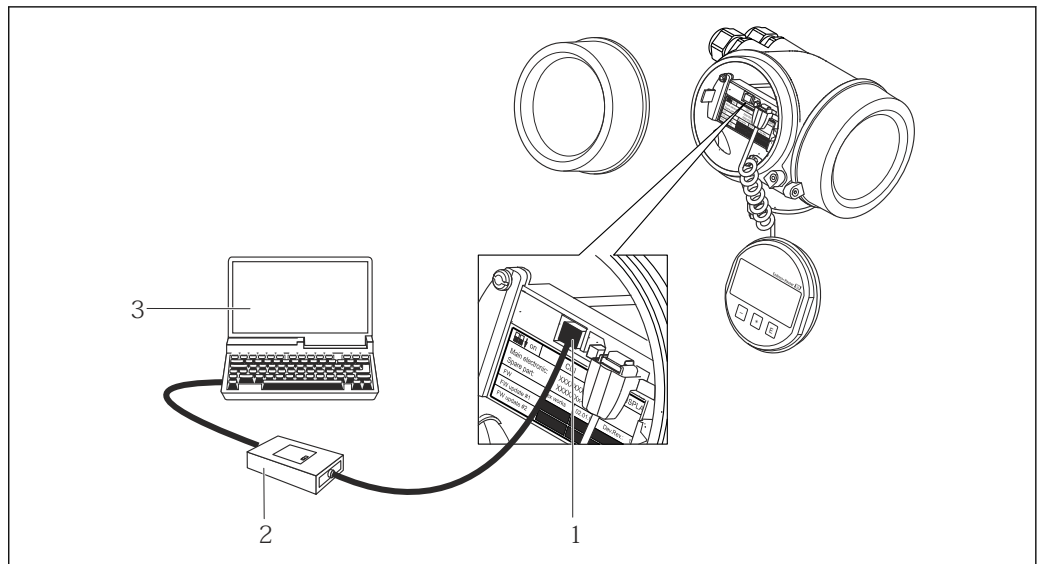

A0014019

- 1 Service interface (CDI = Endress+Hauser Common Data Interface) of the measuring device
- 2 Commubox FXA291
- 3 Computer with "FieldCare" operating tool with COM DTM "CDI Communication FXA291"

8.4.2 Field Xpert SFX350, SFX370

Function scope

Field Xpert SFX350 and Field Xpert SFX370 are mobile computers for commissioning and maintenance. They enable efficient device configuration and diagnostics for HART and FOUNDATION fieldbus devices in the **non-Ex area** (SFX350, SFX370) and the **Ex area** (SFX370).

 For details, see Operating Instructions BA01202S

Source for device description files



See data →  57

8.4.3 FieldCare

Function scope

FDT-based plant asset management tool from Endress+Hauser. It can configure all smart field devices in a system and helps you manage them. By using the status information, it is also a simple but effective way of checking their status and condition.

Access takes place via:

- HART protocol →  53
- Service interface CDI →  53

Typical functions:

- Configuring parameters of transmitters
- Loading and saving device data (upload/download)
- Documentation of the measuring point
- Visualization of the measured value memory (line recorder) and event logbook

 For details, see Operating Instructions BA00027S and BA00059S

Source for device description files

See data →  57

User interface

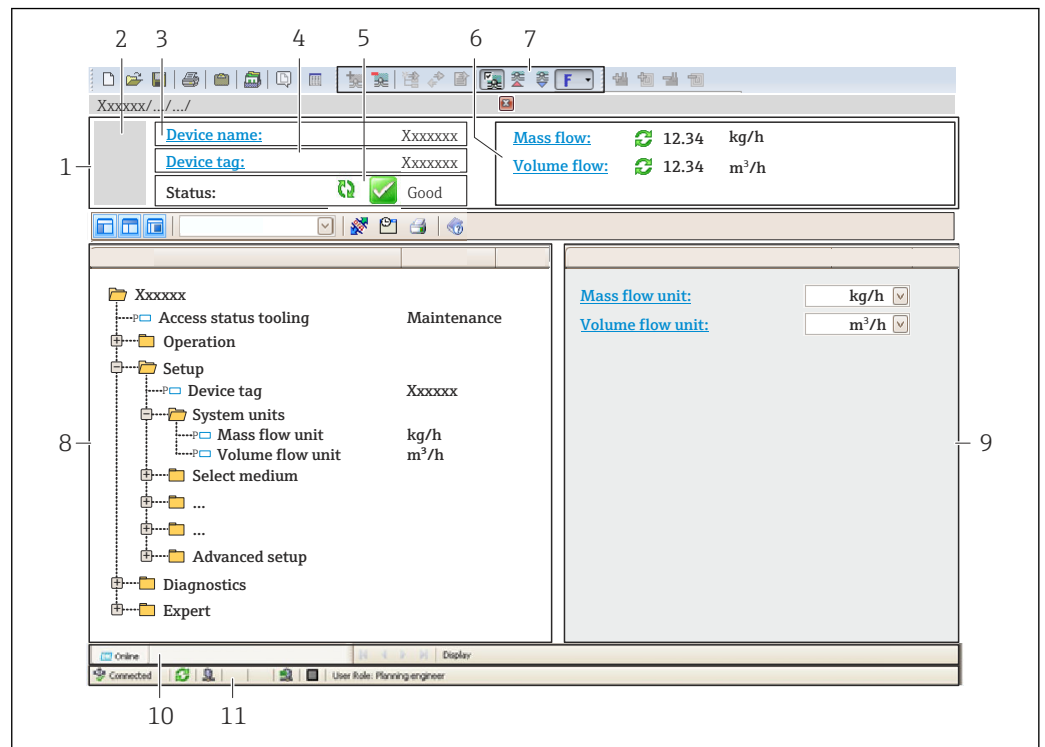

A0021051-EN

- 1 Header
- 2 Picture of device
- 3 Device name
- 4 Device tag
- 5 Status area with status signal
- 6 Display area for current measured values
- 7 Event list with additional functions such as save/load, events list and document creation
- 8 Navigation area with operating menu structure
- 9 Operating range
- 10 Range of action
- 11 Status area

8.4.4 AMS Device Manager

Function scope

Program from Emerson Process Management for operating and configuring measuring devices via HART protocol.

Source for device description files

See data → 57

8.4.5 SIMATIC PDM

Function scope

SIMATIC PDM is a standardized, manufacturer-independent program from Siemens for the operation, configuration, maintenance and diagnosis of intelligent field devices via HART protocol.

Source for device description files

See data → 57

8.4.6 Field Communicator 475

Function scope

Industrial handheld terminal from Emerson Process Management for remote configuration and measured value display via HART protocol.

Source for device description files

See data →  57

9 System integration

9.1 Overview of device description files

9.1.1 Current version data for the device

Firmware version	01.01.zz	<ul style="list-style-type: none"> ▪ On the title page of the Operating instructions ▪ On the transmitter nameplate → 13 ▪ Firmware version ▪ "Diagnostics" menu → Device information → Firmware version
Release date of firmware version	04.2015	---
Manufacturer ID	0x11	Manufacturer ID "Diagnostics" menu → Device information → Manufacturer ID
Device type ID	0x48	Device type "Diagnostics" menu → Device information → Device type
HART protocol revision	7	---
Device revision	2	<ul style="list-style-type: none"> ▪ On the transmitter nameplate → 13 ▪ Device revision ▪ "Diagnostics" menu → Device information → Device revision

9.1.2 Operating tools

Operating tool via HART protocol	Sources for obtaining device descriptions
<ul style="list-style-type: none"> ▪ Field Xpert SFX350 ▪ Field Xpert SFX370 	Use update function of handheld terminal
FieldCare	<ul style="list-style-type: none"> ▪ www.endress.com → Download Area ▪ CD-ROM (contact Endress+Hauser) ▪ DVD (contact Endress+Hauser)
AMS Device Manager (Emerson Process Management)	www.endress.com → Download Area
SIMATIC PDM (Siemens)	www.endress.com → Download Area
Field Communicator 475 (Emerson Process Management)	Use update function of handheld terminal

9.2 Measured variables via HART protocol

The following measured variables (HART device variables) are assigned to the dynamic variables at the factory:

Dynamic variables	Measured variables (HART device variables)
Primary dynamic variable (PV)	Volume flow
Secondary dynamic variable (SV)	Totalizer 1
Tertiary dynamic variable (TV)	Totalizer 2
Quaternary dynamic variable (QV)	Totalizer 3

The assignment of the measured variables to the dynamic variables can be modified and assigned as desired via local operation and the operating tool using the following parameters:

- Expert → Communication → HART output → Output → Assign PV
- Expert → Communication → HART output → Output → Assign SV
- Expert → Communication → HART output → Output → Assign TV
- Expert → Communication → HART output → Output → Assign QV

The following measured variables can be assigned to the dynamic variables:

Measured variables for PV (primary dynamic variable)

- Volume flow
- Mass flow

Measured variables for SV, TV, QV (secondary, tertiary and quaternary dynamic variable)

- Volume flow
- Mass flow
- Totalizer 1
- Totalizer 2
- Totalizer 3

9.3 Other settings

9.3.1 Burst mode functionality in accordance with HART 7 Specification

Navigation

"Expert" menu → Communication → HART output → Burst configuration → Burst configuration 1 to 3

The screenshot shows a hierarchical menu structure for burst configuration. At the top is a grey button labeled '► Burst configuration'. Below it is another grey button labeled '► Burst configuration 1 to 3'. Underneath this, there is a vertical list of text boxes containing the following labels: 'Burst mode 1 to 3', 'Burst command 1 to 3', 'Burst variable 0', 'Burst variable 1', 'Burst variable 2', 'Burst variable 3', 'Burst variable 4', and 'Burst variable 5'.

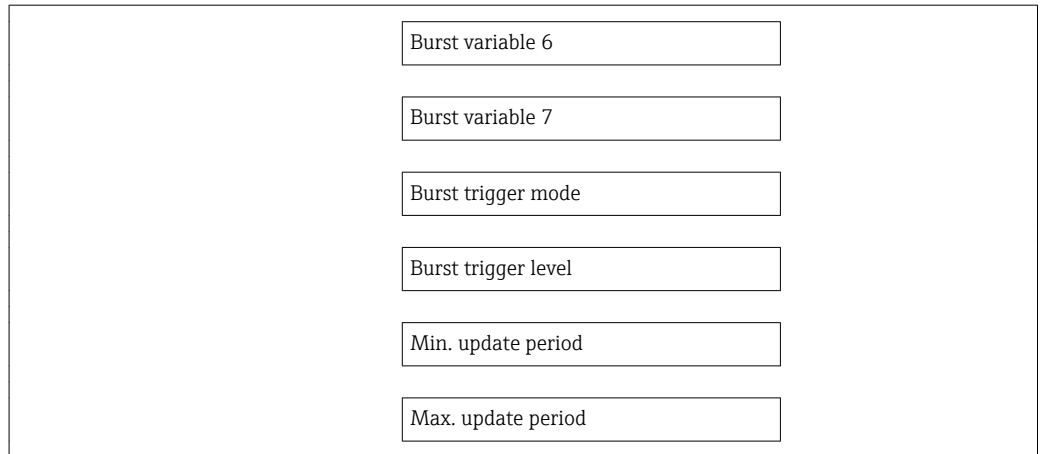

Parameter overview with brief description

Parameter	Description	Selection / User entry	Factory setting
Burst mode 1 to 3	Activate the HART burst mode for burst message X.	<ul style="list-style-type: none"> ■ Off ■ On 	Off
Burst command 1 to 3	Select the HART command that is sent to the HART master.	<ul style="list-style-type: none"> ■ Command 1 ■ Command 2 ■ Command 3 ■ Command 9 ■ Command 33 ■ Command 48 	Command 2
Burst variable 0	For HART command 9 and 33, assign a HART device variable or process variable to burst variable.	<ul style="list-style-type: none"> ■ Volume flow ■ Mass flow ■ Totalizer 1 ■ Totalizer 2 ■ Totalizer 3 ■ Percent Of Range ■ Measured current ■ Primary variable (PV) ■ Secondary variable (SV) ■ Tertiary variable (TV) ■ Quaternary variable (QV) ■ Not used 	Volume flow
Burst variable 1	For HART command 9 and 33, assign a HART device variable or process variable to burst variable.	See Burst variable 0 parameter.	Not used
Burst variable 2	For HART command 9 and 33, assign a HART device variable or process variable to burst variable.	See Burst variable 0 parameter.	Not used
Burst variable 3	For HART command 9 and 33, assign a HART device variable or process variable to burst variable.	See Burst variable 0 parameter.	Not used
Burst variable 4	For HART command 33, assign a HART device variable or process variable to burst variable.	See Burst variable 0 parameter.	Not used
Burst variable 5	For HART command 33, assign a HART device variable or process variable to burst variable.	See Burst variable 0 parameter.	Not used
Burst variable 6	For HART command 33, assign a HART device variable or process variable to burst variable.	See Burst variable 0 parameter.	Not used
Burst variable 7	For HART command 33, assign a HART device variable or process variable to burst variable.	See Burst variable 0 parameter.	Not used

Parameter	Description	Selection / User entry	Factory setting
Burst trigger mode	Select the event that triggers burst message X.	<ul style="list-style-type: none"> ■ Continuous ■ Window ■ Rising ■ Falling ■ On change 	Continuous
Burst trigger level	Enter the burst trigger value. Together with the option selected in the Burst trigger mode parameter the burst trigger value determines the time of burst message X.	Positive floating-point number	2.0E-38
Min. update period	Enter the minimum time span between two burst responses of one burst message.	Positive integer	1 000 ms
Max. update period	Enter the maximum time span between two burst responses of one burst message.	Positive integer	2 000 ms

10 Commissioning

10.1 Function check

Before commissioning the measuring device:

- ▶ Make sure that the post-installation and post-connection checks have been performed.
- "Post-installation check" checklist → 28
- "Post-connection check" checklist → 37

10.2 Switching on the measuring device

- ▶ After a successful function check, switch on the measuring device.
 - ↳ After a successful startup, the local display switches automatically from the startup display to the operational display.

If nothing appears on the local display or a diagnostic message is displayed, refer to the section on "Diagnostics and troubleshooting" → 97.

10.3 Setting the operating language

Factory setting: English or ordered local language

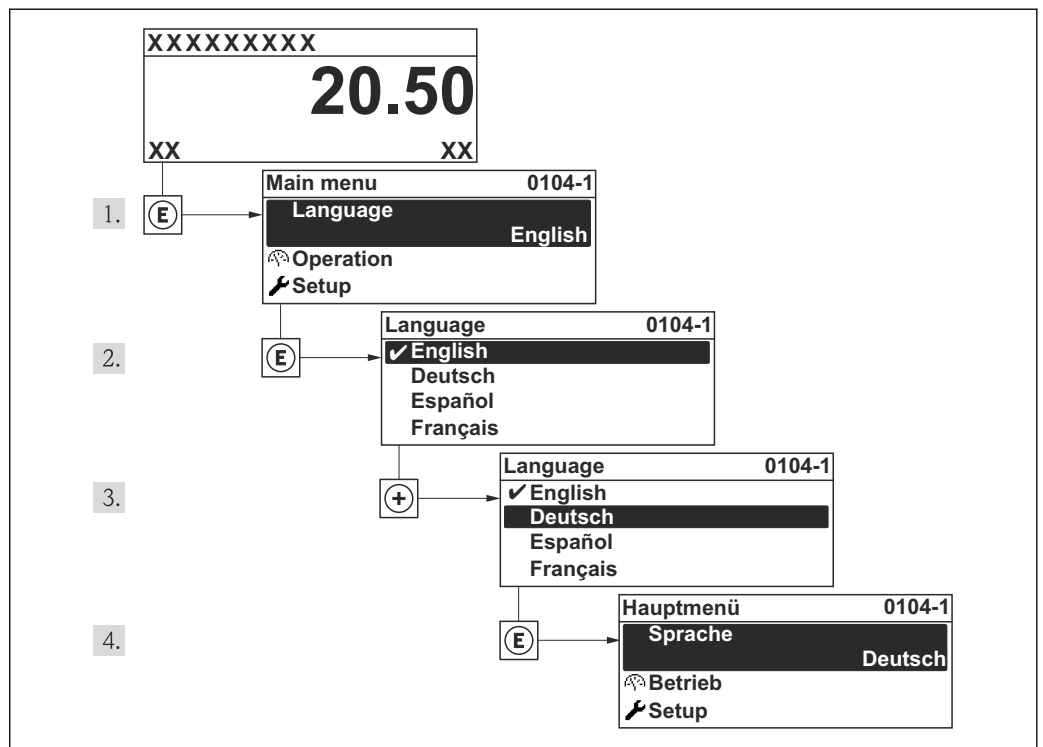

16 Taking the example of the local display

A0013996

10.4 Configuring the measuring device

The **Setup** menu with its guided wizards contains all the parameters needed for standard operation.

Navigation to the **Setup** menu

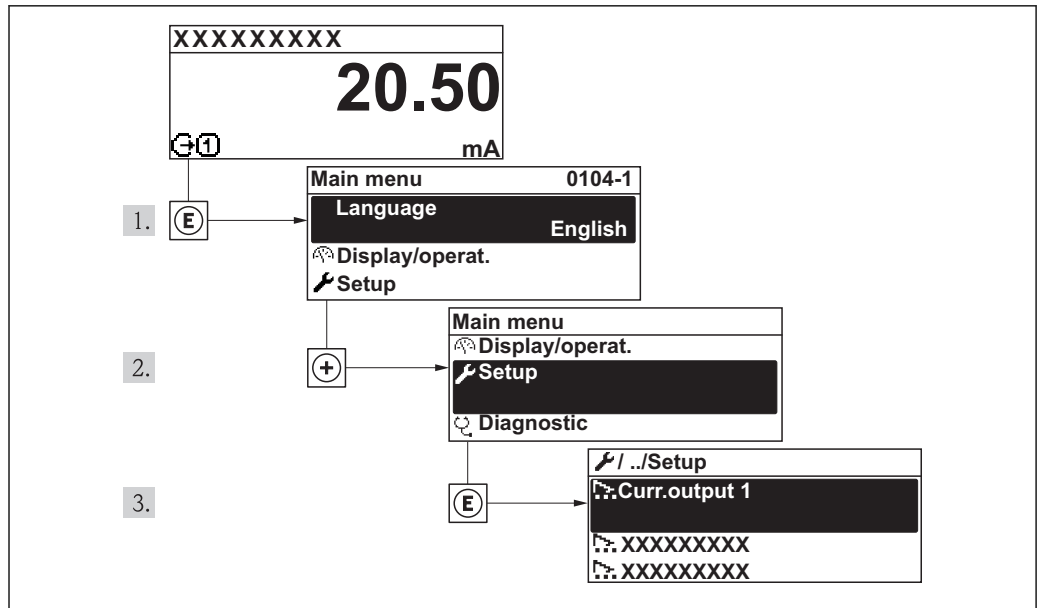

A0018774-EN

17 Using the example of the local display

Navigation

"Setup" menu

🔧 Setup	
Device tag	→ 63
▶ System units	→ 63
▶ Current output 1	→ 65
▶ Pulse/frequency/switch output	→ 67
▶ Display	→ 73
▶ Output conditioning	→ 75
▶ Low flow cut off	→ 76
▶ Empty pipe detection	→ 78
▶ Advanced setup	→ 79

10.4.1 Defining the tag name

To enable fast identification of the measuring point within the system, you can enter a unique designation using the **Device tag** parameter and thus change the factory setting.

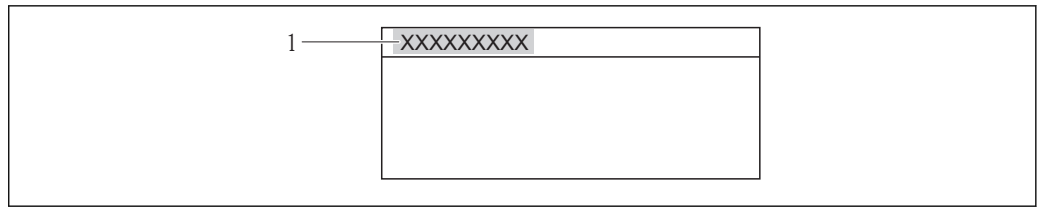

A0013375

18 Header of the operational display with tag name

1 Device tag

i The number of characters displayed depends on the characters used.
 Entry of the tag name in the "FieldCare" operating tool → 55

Navigation
 "Setup" menu → Device tag

Parameter overview with brief description

Parameter	Description	User entry	Factory setting
Device tag	Enter the name for the measuring point.	Max. 32 characters, such as letters, numbers or special characters (e.g. @, %, /).	Promag

10.4.2 Setting the system units

In the **System units** submenu the units of all the measured values can be set.

Navigation
 "Setup" menu → Advanced setup → System units

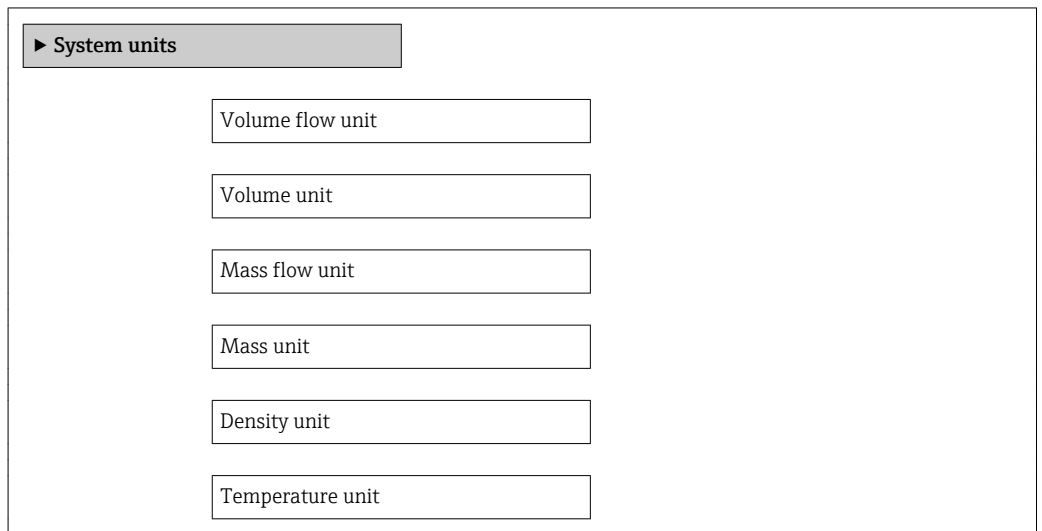

Parameter overview with brief description

Parameter	Description	Selection	Factory setting
Volume flow unit	Select volume flow unit. <i>Result</i> The selected unit applies for: <ul style="list-style-type: none"> ▪ Output ▪ Low flow cut off ▪ Simulation process variable 	Unit choose list	Country-specific: <ul style="list-style-type: none"> ▪ l/h ▪ gal/min (us)
Volume unit	Select volume unit. Result The selected unit is taken from: Volume flow unit parameter	Unit choose list	Country-specific: <ul style="list-style-type: none"> ▪ l ▪ gal (us)
Temperature unit	Select temperature unit. <i>Result</i> The selected unit applies for: <ul style="list-style-type: none"> ▪ Output ▪ Reference temperature ▪ Simulation process variable 	Unit choose list	Country-specific: <ul style="list-style-type: none"> ▪ °C (Celsius) ▪ °F (Fahrenheit)
Mass flow unit	Select mass flow unit. <i>Result</i> The selected unit applies for: <ul style="list-style-type: none"> ▪ Output ▪ Low flow cut off ▪ Simulation process variable 	Unit choose list	Country-specific: <ul style="list-style-type: none"> ▪ kg/h ▪ lb/min
Mass unit	Select mass unit. <i>Result</i> The selected unit is taken from: Mass flow unit parameter	Unit choose list	Country-specific: <ul style="list-style-type: none"> ▪ kg ▪ lb
Density unit	Select density unit. <i>Result</i> The selected unit applies for: <ul style="list-style-type: none"> ▪ Output ▪ Simulation process variable 	Unit choose list	Country-specific: <ul style="list-style-type: none"> ▪ kg/l ▪ lb/ft³

10.4.3 Configuring the current output

The "Current output 1" wizard guides you systematically through all the parameters that have to be set for configuring the specific current output.

Navigation

"Setup" menu → Current output 1

Structure of the wizard

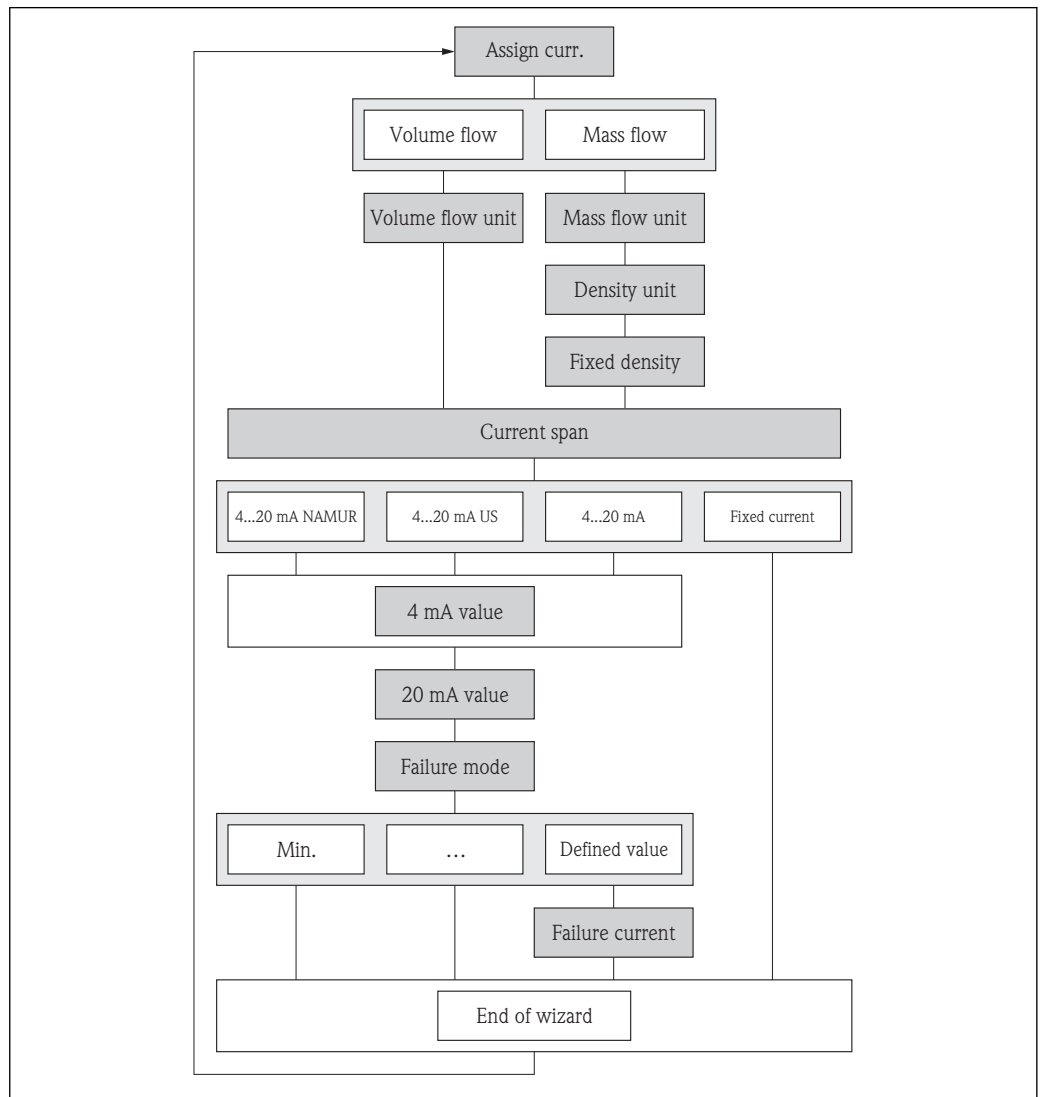

19 "Current output 1" wizard in the "Setup" menu

A0018498-EN

Parameter overview with brief description

Parameter	Prerequisite	Description	Selection / User entry	Factory setting
Assign current output	–	Select process variable for current output.	<ul style="list-style-type: none"> ▪ Off ▪ Volume flow ▪ Mass flow 	Volume flow
Mass flow unit	–	Select mass flow unit. <i>Result</i> The selected unit applies for: <ul style="list-style-type: none"> ▪ Output ▪ Low flow cut off ▪ Simulation process variable 	Unit choose list	Country-specific: <ul style="list-style-type: none"> ▪ kg/h ▪ lb/min
Volume flow unit	–	Select volume flow unit. <i>Result</i> The selected unit applies for: <ul style="list-style-type: none"> ▪ Output ▪ Low flow cut off ▪ Simulation process variable 	Unit choose list	Country-specific: <ul style="list-style-type: none"> ▪ l/h ▪ gal/min (us)
Current span	–	Select current range for process value output and upper/lower level for alarm signal.	<ul style="list-style-type: none"> ▪ 4...20 mA NAMUR ▪ 4...20 mA US ▪ 4...20 mA ▪ Fixed current 	Country-specific: <ul style="list-style-type: none"> ▪ 4...20 mA NAMUR ▪ 4...20 mA US
4 mA value	One of the following options is selected in the Current span parameter (→ 66): <ul style="list-style-type: none"> ▪ 4...20 mA NAMUR ▪ 4...20 mA US ▪ 4...20 mA 	Enter 4 mA value.	Signed floating-point number	Country-specific: <ul style="list-style-type: none"> ▪ 0 m³/h ▪ 0 ft³/min
20 mA value	One of the following options is selected in the Current span parameter (→ 66): <ul style="list-style-type: none"> ▪ 4...20 mA NAMUR ▪ 4...20 mA US ▪ 4...20 mA 	Enter 20 mA value.	Signed floating-point number	Depends on country and nominal diameter
Failure mode	One of the following options is selected in the Assign current output parameter (→ 66): <ul style="list-style-type: none"> ▪ Volume flow ▪ Mass flow One of the following options is selected in the Current span parameter (→ 66): <ul style="list-style-type: none"> ▪ 4...20 mA NAMUR ▪ 4...20 mA US ▪ 4...20 mA 	Define output behavior in alarm condition.	<ul style="list-style-type: none"> ▪ Min. ▪ Max. ▪ Last valid value ▪ Actual value ▪ Defined value 	Max.
Failure current	The Defined value option is selected in the Failure mode parameter.	Enter current output value in alarm condition.	3.59 to 22.5 mA	22.5 mA

10.4.4 Configuring the pulse/frequency/switch output

The **Pulse/frequency/switch output** wizard guides you systematically through all the parameters that can be set for configuring the selected output type.

Configuring the pulse output

Navigation

"Setup" menu → Pulse/frequency/switch output

Structure of the wizard for the pulse output

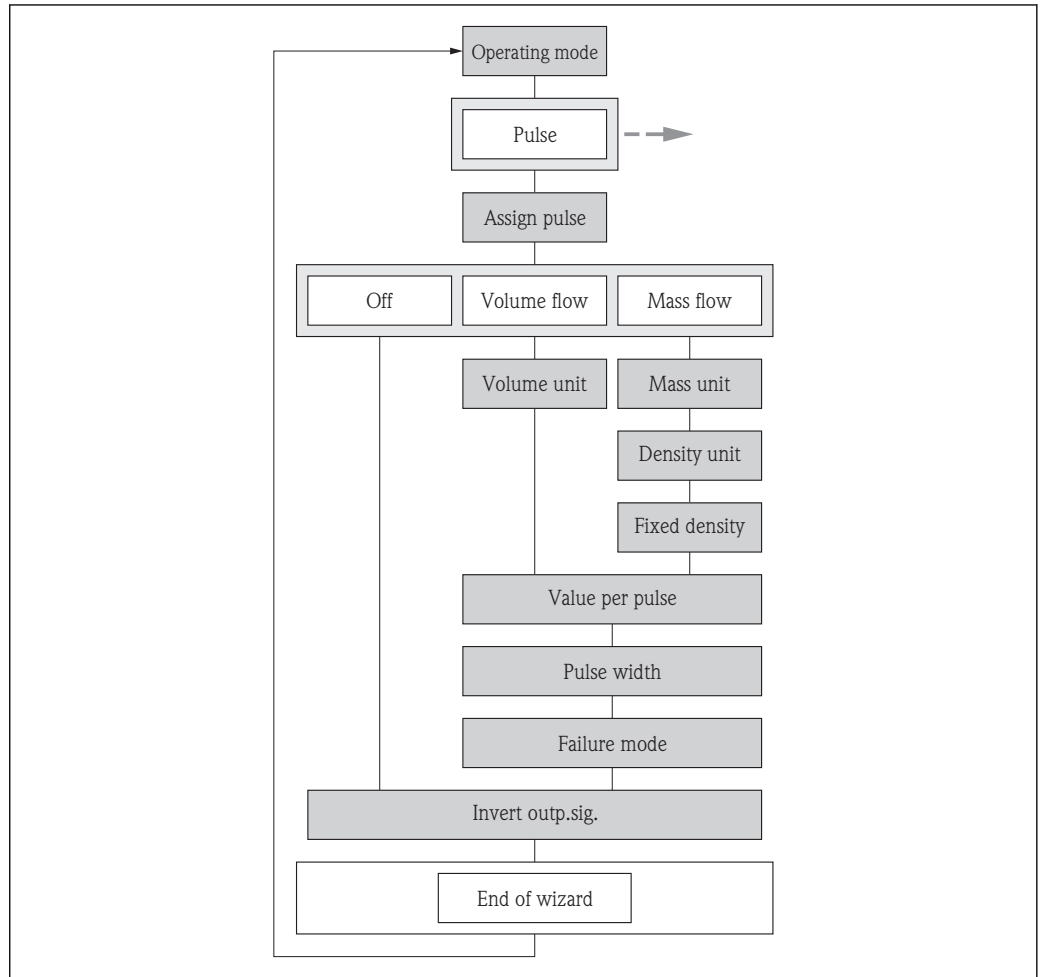

A0018551-EN

20 "Pulse/frequency/switch output" wizard in the "Setup" menu: "Operating mode" parameter "Pulse" option

Parameter overview with brief description

Parameter	Description	Selection / User entry	Factory setting
Operating mode	Define the output as a pulse, frequency or switch output.	<ul style="list-style-type: none"> ■ Pulse ■ Frequency ■ Switch 	Pulse
Assign pulse output	Select process variable for pulse output.	<ul style="list-style-type: none"> ■ Off ■ Mass flow ■ Volume flow 	Off
Mass unit	Select mass unit. <i>Result</i> The selected unit is taken from: Mass flow unit parameter	Unit choose list	Country-specific: <ul style="list-style-type: none"> ■ kg ■ lb
Volume unit	Select volume unit. Result The selected unit is taken from: Volume flow unit parameter	Unit choose list	Country-specific: <ul style="list-style-type: none"> ■ l ■ gal (us)

Parameter	Description	Selection / User entry	Factory setting
Density unit	Select density unit. <i>Result</i> The selected unit applies for: <ul style="list-style-type: none"> ▪ Output ▪ Simulation process variable 	Unit choose list	Country-specific: <ul style="list-style-type: none"> ▪ kg/l ▪ lb/ft³
Value per pulse	Enter measured value at which a pulse is output.	Signed floating-point number	0
Pulse width	Define time width of the output pulse.	5 to 2 000 ms	100 ms
Failure mode	Define output behavior in alarm condition.	<ul style="list-style-type: none"> ▪ Actual value ▪ No pulses 	No pulses
Invert output signal	Invert the output signal.	<ul style="list-style-type: none"> ▪ No ▪ Yes 	No

Configuring the frequency output

Navigation

"Setup" menu → Pulse/frequency/switch output

Structure of the wizard for the frequency output

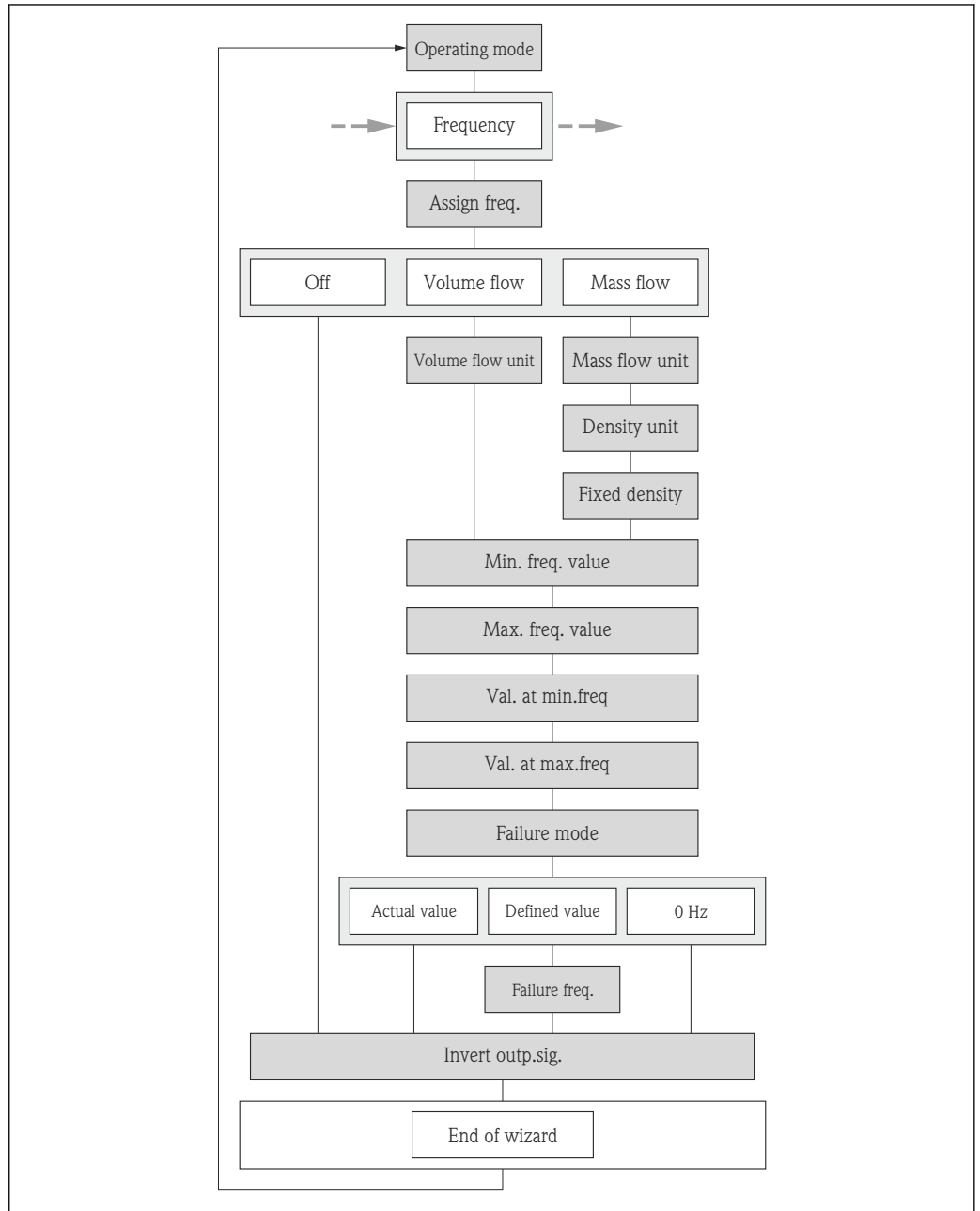

A0018557-EN

21 "Pulse/frequency/switch output" wizard in the "Setup" menu: "Operating mode" parameter "Frequency" option

Parameter overview with brief description

Parameter	Description	Selection / User entry	Factory setting
Operating mode	Define the output as a pulse, frequency or switch output.	<ul style="list-style-type: none"> ■ Pulse ■ Frequency ■ Switch 	Pulse
Assign frequency output	Select process variable for frequency output.	<ul style="list-style-type: none"> ■ Off ■ Volume flow ■ Mass flow 	Off
Mass flow unit	Select mass flow unit. <i>Result</i> The selected unit applies for: <ul style="list-style-type: none"> ■ Output ■ Low flow cut off ■ Simulation process variable 	Unit choose list	Country-specific: <ul style="list-style-type: none"> ■ kg/h ■ lb/min
Volume flow unit	Select volume flow unit. <i>Result</i> The selected unit applies for: <ul style="list-style-type: none"> ■ Output ■ Low flow cut off ■ Simulation process variable 	Unit choose list	Country-specific: <ul style="list-style-type: none"> ■ l/h ■ gal/min (us)
Density unit	Select density unit. <i>Result</i> The selected unit applies for: <ul style="list-style-type: none"> ■ Output ■ Simulation process variable 	Unit choose list	Country-specific: <ul style="list-style-type: none"> ■ kg/l ■ lb/ft³
Minimum frequency value	Enter minimum frequency.	0.0 to 1 000.0 Hz	0.0 Hz
Maximum frequency value	Enter maximum frequency.	0.0 to 1 000.0 Hz	1 000.0 Hz
Measuring value at minimum frequency	Enter measured value for minimum frequency.	Signed floating-point number	0
Measuring value at maximum frequency	Enter measured value for maximum frequency.	Signed floating-point number	0
Failure mode	Define output behavior in alarm condition.	<ul style="list-style-type: none"> ■ Actual value ■ Defined value ■ 0 Hz 	0 Hz
Failure frequency	Enter frequency output value in alarm condition.	0.0 to 1 250.0 Hz	0.0 Hz
Invert output signal	Invert the output signal.	<ul style="list-style-type: none"> ■ No ■ Yes 	No

Configuring the switch output

Navigation

"Setup" menu → Pulse/frequency/switch output

Structure of the wizard for the switch output

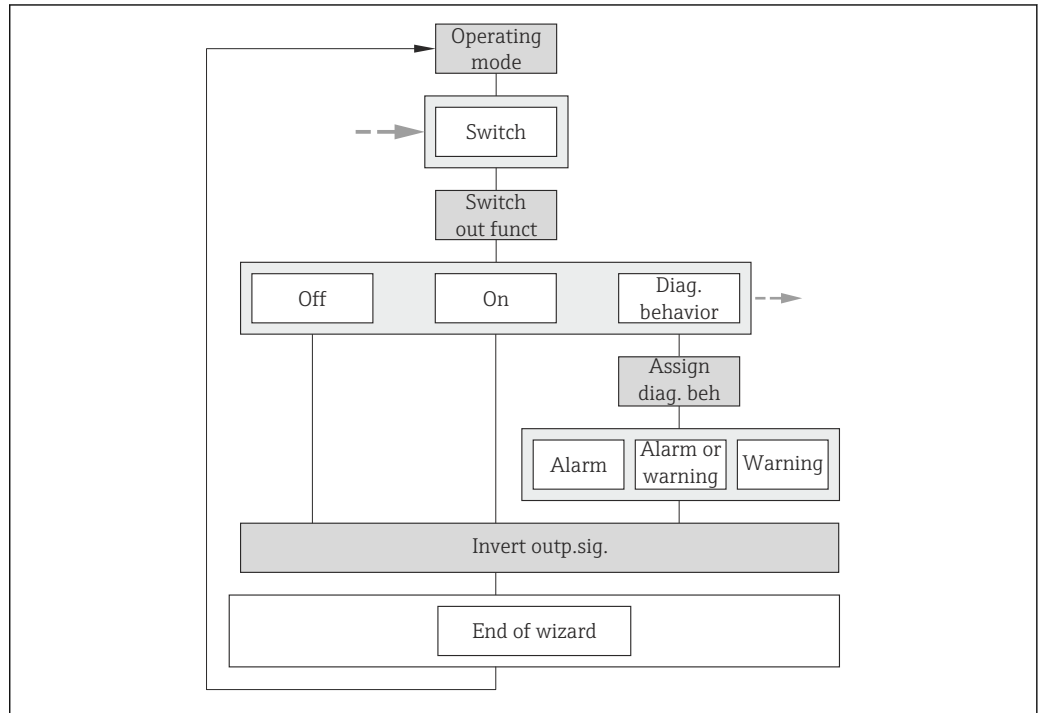

A0018575-EN

22 "Pulse/frequency/switch output" wizard in the "Setup" menu: "Operating mode" parameter "Switch" option (part 1)

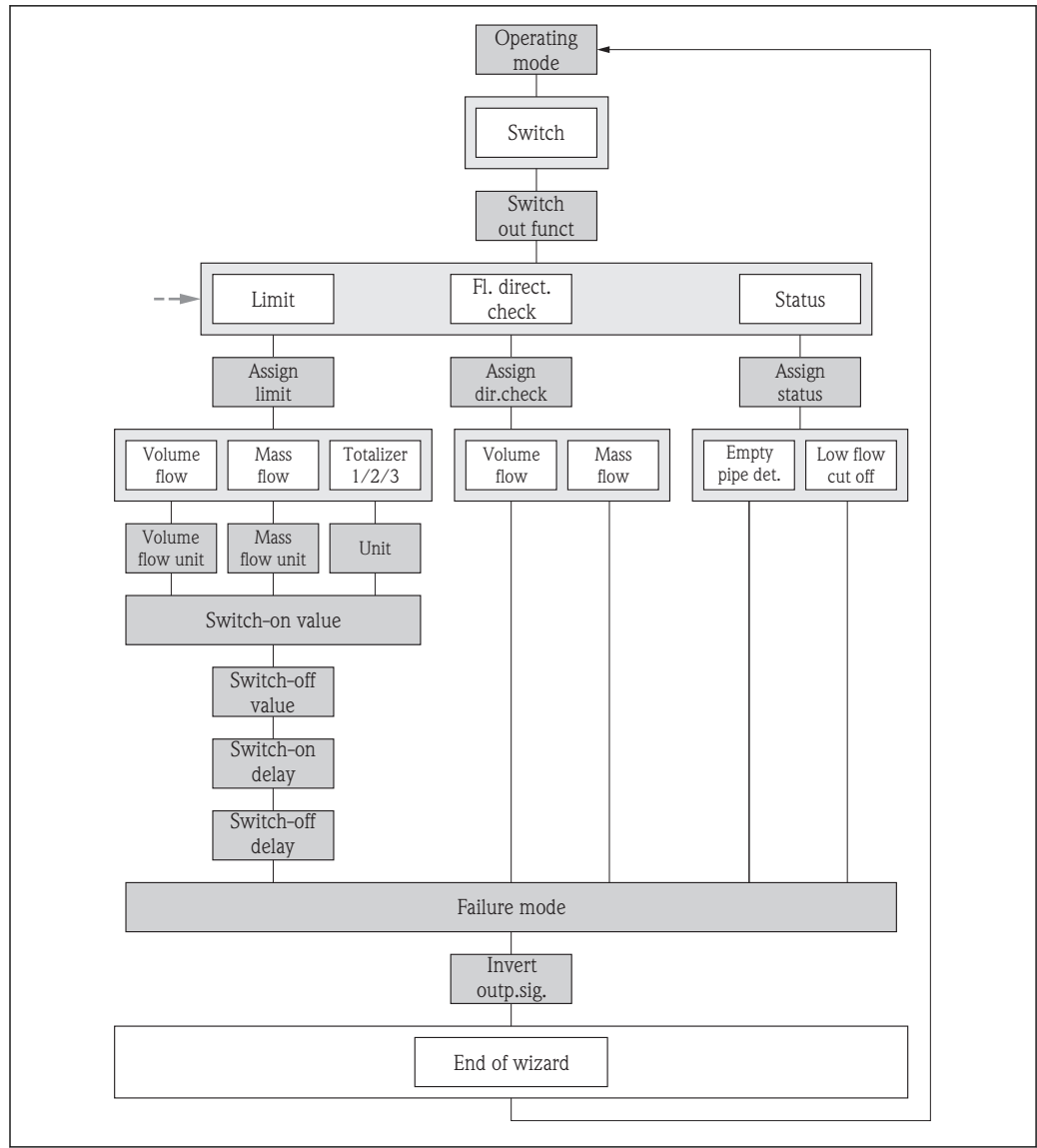

A0018576-EN

23 "Pulse/frequency/switch output" wizard in the "Setup" menu: "Operating mode" parameter "Switch" option (part 2)

Parameter overview with brief description

Parameter	Description	Selection / User entry	Factory setting
Operating mode	Define the output as a pulse, frequency or switch output.	<ul style="list-style-type: none"> ▪ Pulse ▪ Frequency ▪ Switch 	Pulse
Switch output function	Select function for switch output.	<ul style="list-style-type: none"> ▪ Off ▪ On ▪ Diagnostic behavior ▪ Limit ▪ Flow direction check ▪ Status 	Off
Assign diagnostic behavior	Select diagnostic behavior for switch output.	<ul style="list-style-type: none"> ▪ Alarm ▪ Alarm or warning ▪ Warning 	Alarm
Assign limit	Select process variable for limit function.	<ul style="list-style-type: none"> ▪ Volume flow ▪ Mass flow ▪ Totalizer 1 ▪ Totalizer 2 ▪ Totalizer 3 	Volume flow

Parameter	Description	Selection / User entry	Factory setting
Assign flow direction check	Select process variable for flow direction monitoring.	<ul style="list-style-type: none"> ■ Volume flow ■ Mass flow 	Volume flow
Assign status	Select device status for switch output.	<ul style="list-style-type: none"> ■ Empty pipe detection ■ Low flow cut off 	Empty pipe detection
Volume flow unit	Select volume flow unit. <i>Result</i> The selected unit applies for: <ul style="list-style-type: none"> ■ Output ■ Low flow cut off ■ Simulation process variable 	Unit choose list	Country-specific: <ul style="list-style-type: none"> ■ l/h ■ gal/min (us)
Mass flow unit	Select mass flow unit. <i>Result</i> The selected unit applies for: <ul style="list-style-type: none"> ■ Output ■ Low flow cut off ■ Simulation process variable 	Unit choose list	Country-specific: <ul style="list-style-type: none"> ■ kg/h ■ lb/min
Unit totalizer	Select process variable totalizer unit.	Unit choose list	l
Switch-on value	Enter measured value for the switch-on point.	Signed floating-point number	0 l/h
Switch-off value	Enter measured value for the switch-off point.	Signed floating-point number	0 l/h
Switch-on delay	Define delay for the switch-on of status output.	0.0 to 100.0 s	0.0 s
Switch-off delay	Define delay for the switch-off of status output.	0.0 to 100.0 s	0.0 s
Failure mode	Define output behavior in alarm condition.	<ul style="list-style-type: none"> ■ Actual status ■ Open ■ Closed 	Open
Invert output signal	Invert the output signal.	<ul style="list-style-type: none"> ■ No ■ Yes 	No

10.4.5 Configuring the local display

The **Display** wizard guides you systematically through all the parameters that can be configured for configuring the local display.

Navigation

"Setup" menu → Display

Structure of the wizard

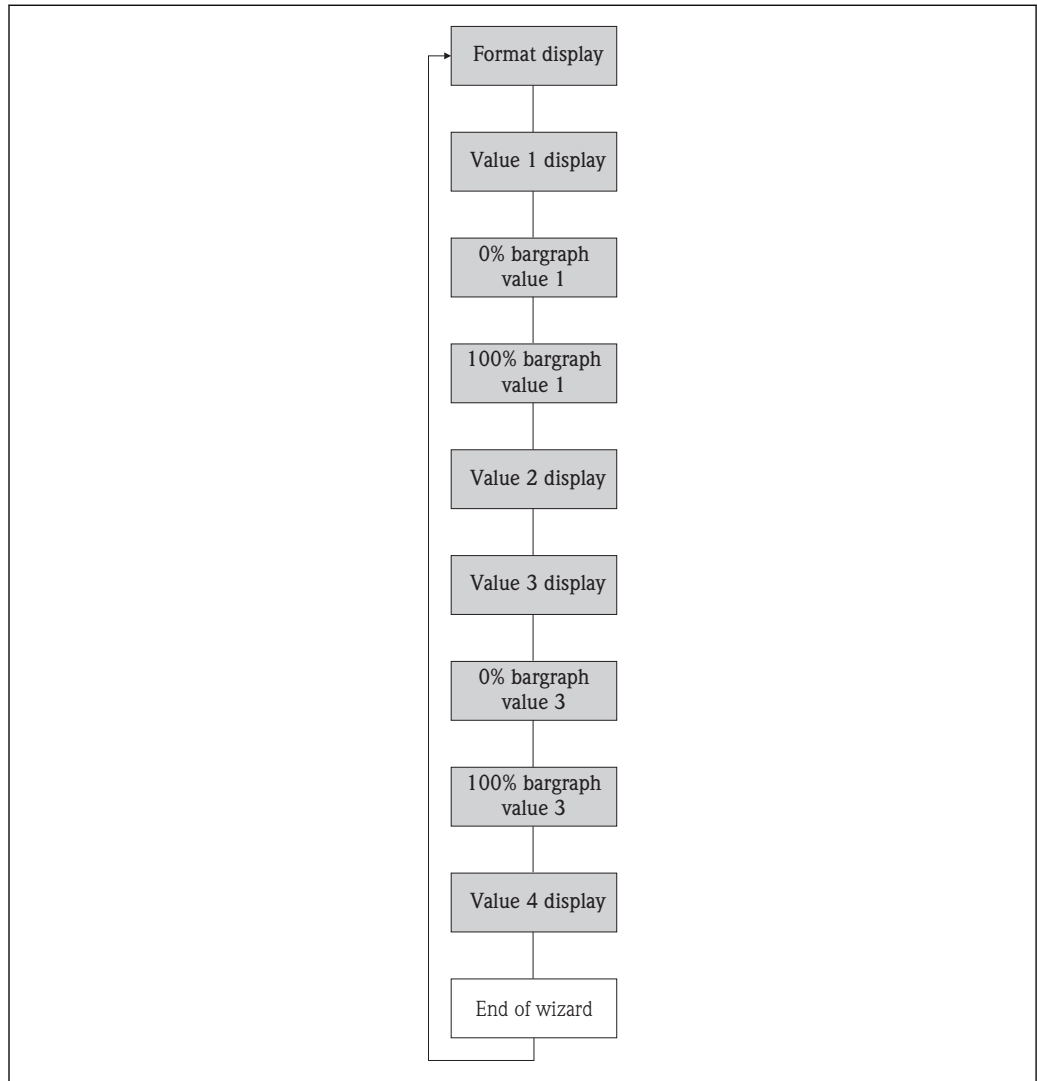

A0013797-EN

24 "Display" wizard in the "Setup" menu

Parameter overview with brief description

Parameter	Prerequisite	Description	Selection / User entry	Factory setting
Format display	A local display is provided.	Select how measured values are shown on the display.	<ul style="list-style-type: none"> ▪ 1 value, max. size ▪ 1 bargraph + 1 value ▪ 2 values ▪ 1 value large + 2 values ▪ 4 values 	1 value, max. size
Value 1 display	A local display is provided.	Select the measured value that is shown on the local display.	<ul style="list-style-type: none"> ▪ Volume flow ▪ Mass flow ▪ Totalizer 1 ▪ Totalizer 2 ▪ Totalizer 3 ▪ Current output 1 	Volume flow

Parameter	Prerequisite	Description	Selection / User entry	Factory setting
0% bargraph value 1	A local display is provided.	Enter 0% value for bar graph display.	Signed floating-point number	0 l/h
100% bargraph value 1	A local display is provided.	Enter 100% value for bar graph display.	Signed floating-point number	Depends on country and nominal diameter
Value 2 display	A local display is provided.	Select the measured value that is shown on the local display.	Picklist (see Value 1 display)	None
Value 3 display	A local display is provided.	Select the measured value that is shown on the local display.	Picklist (see Value 1 display)	None
0% bargraph value 3	An option was selected in the Value 3 display parameter.	Enter 0% value for bar graph display.	Signed floating-point number	0
100% bargraph value 3	An option was selected in the Value 3 display parameter.	Enter 100% value for bar graph display.	Signed floating-point number	Depends on country and nominal diameter
Value 4 display	A local display is provided.	Select the measured value that is shown on the local display.	Picklist (see Value 1 display)	None

10.4.6 Configuring the output conditioning

The **Output conditioning** wizard guides you systematically through all the parameters that have to be set for configuring the output conditioning.

Navigation

"Setup" menu → Output conditioning

Structure of the "Output conditioning" wizard

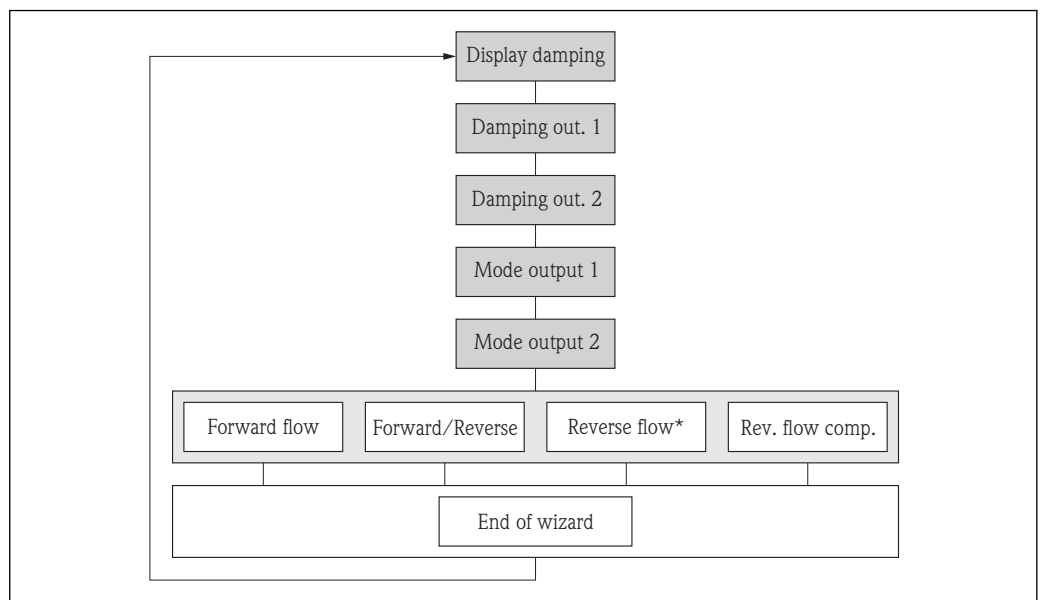

25 "Output conditioning" wizard in the "Setup" menu

Reverse flow* = option only for pulse and frequency output

Parameter overview with brief description

Parameter	Prerequisite	Description	User entry / Selection	Factory setting
Display damping	–	Set display reaction time to fluctuations in the measured value.	0.0 to 999.9 s	0.0 s
Damping output 1	–	Set the reaction time of the output signal of the current output to fluctuations in the measured value.	0 to 999.9 s	1 s
Damping output 2	The measuring device has a second current output.	Set the reaction time of the output signal of the second current output to fluctuations in the measured value.	0 to 999.9 s	1 s
Damping output 2	The measuring device has a pulse/frequency/switch output.	Set the reaction time of the output signal of the frequency output to fluctuations in the measured value.	0 to 999.9 s	1 s
Measuring mode output 1	–	Select measuring mode for output.	<ul style="list-style-type: none"> ▪ Forward flow ▪ Forward/Reverse flow ▪ Reverse flow compensation 	Forward flow
Measuring mode output 2	–	Select measuring mode for output.	<ul style="list-style-type: none"> ▪ Forward flow ▪ Forward/Reverse flow ▪ Reverse flow compensation 	Forward flow
Measuring mode output 2	–	Select measuring mode for output.	<ul style="list-style-type: none"> ▪ Forward flow ▪ Forward/Reverse flow ▪ Reverse flow ▪ Reverse flow compensation 	Forward flow
Measuring mode output 2	–	Select measuring mode for output.	<ul style="list-style-type: none"> ▪ Forward flow ▪ Forward/Reverse flow ▪ Reverse flow ▪ Reverse flow compensation 	Forward flow

10.4.7 Configuring the low flow cut off

The **Low flow cut off** wizard guides you systematically through all the parameters that have to be set for configuring the low flow cut off.

Navigation

"Setup" menu → Low flow cut off

Structure of the wizard

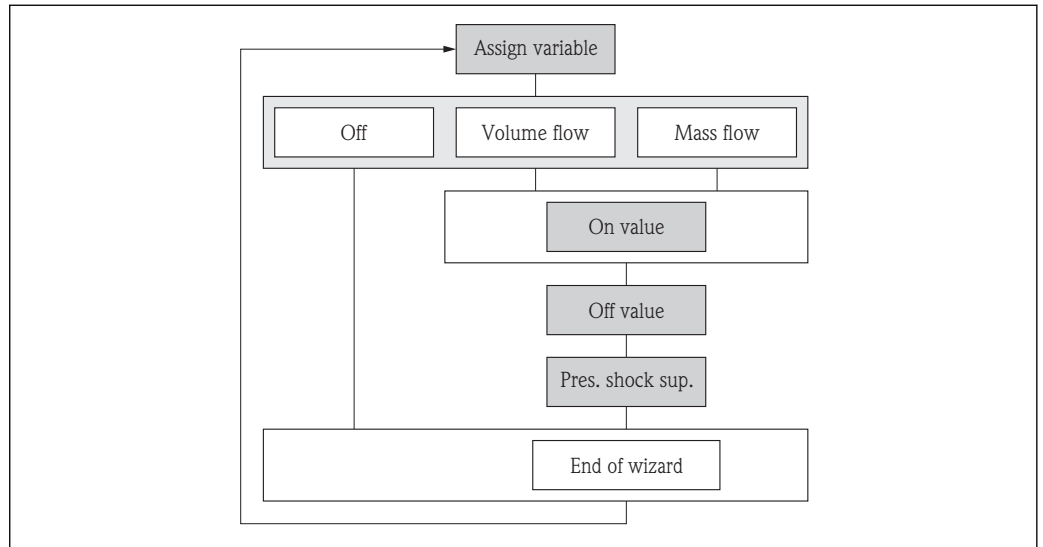

A0017209-EN

26 "Low flow cut off" wizard in the "Setup" menu

Parameter overview with brief description

Parameter	Description	Selection / User entry	Factory setting
Assign process variable	Select process variable for low flow cut off.	<ul style="list-style-type: none"> ■ Off ■ Volume flow ■ Mass flow 	Volume flow
On value low flow cutoff	Enter on value for low flow cut off.	Signed floating-point number	0 l/h
Off value low flow cutoff	Enter off value for low flow cut off.	0 to 100.0 %	50 %
Pressure shock suppression	Enter time frame for signal suppression (= active pressure shock suppression).	0 to 100 s	0 s

10.4.8 Configuring empty pipe detection

The **Empty pipe detection** wizard guides you systematically through all the parameters that have to be set for configuring empty pipe detection.

Navigation

"Setup" menu → Empty pipe detection

Structure of the wizard

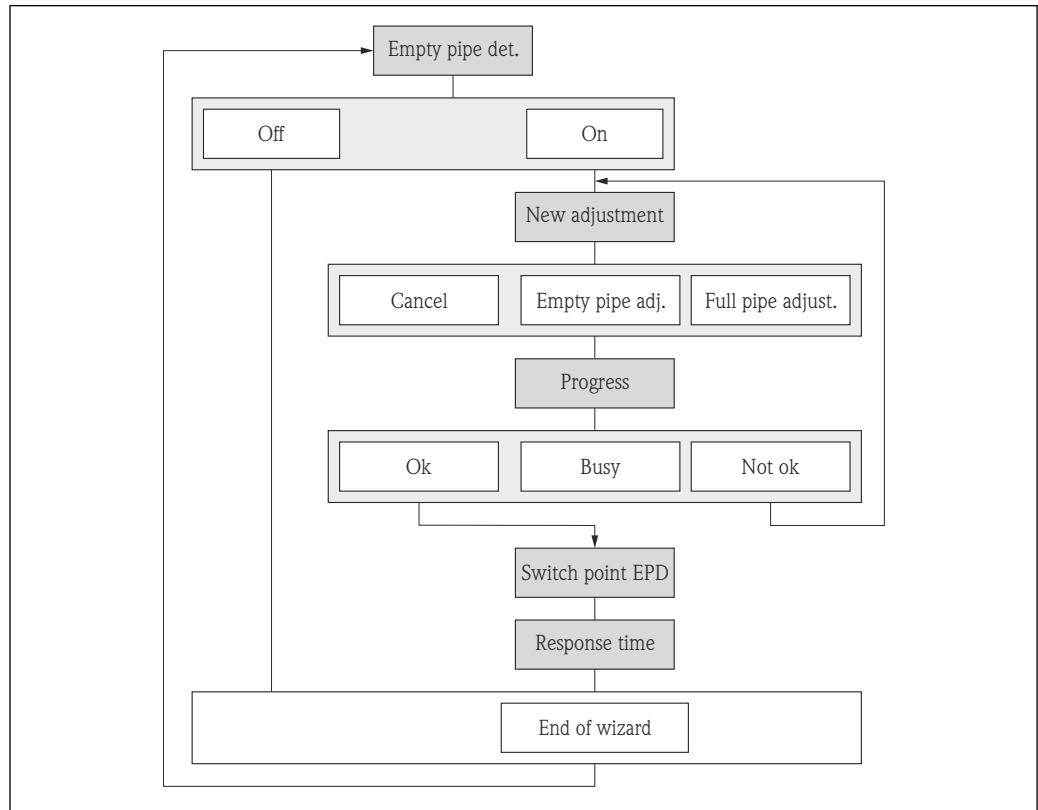

Fig. 27 "Empty pipe detection" wizard in the "Setup" menu

A0017210-EN

Parameter overview with brief description

Parameter	Prerequisite	Description	Selection / User interface / User entry	Factory setting
Empty pipe detection	–	Switch empty pipe detection on and off.	<ul style="list-style-type: none"> ▪ Off ▪ On 	Off
New adjustment	–	Select type of adjustment.	<ul style="list-style-type: none"> ▪ Cancel ▪ Empty pipe adjust ▪ Full pipe adjust 	Cancel
Progress	The On option is selected in the Empty pipe detection parameter.	Shows the progress.	<ul style="list-style-type: none"> ▪ Ok ▪ Busy ▪ Not ok 	–
Switch point empty pipe detection	–	Enter hysteresis in %, below this value the measuring tube will be detected as empty.	1 to 99 %	10 %
Response time empty pipe detection	–	Enter the time before diagnostic message S862 'Pipe empty' is displayed for empty pipe detection.	0 to 100 s	1 s

10.5 Advanced settings

The **Advanced setup** submenu with its submenus contains parameters for specific settings.

Navigation to the "Advanced setup" submenu

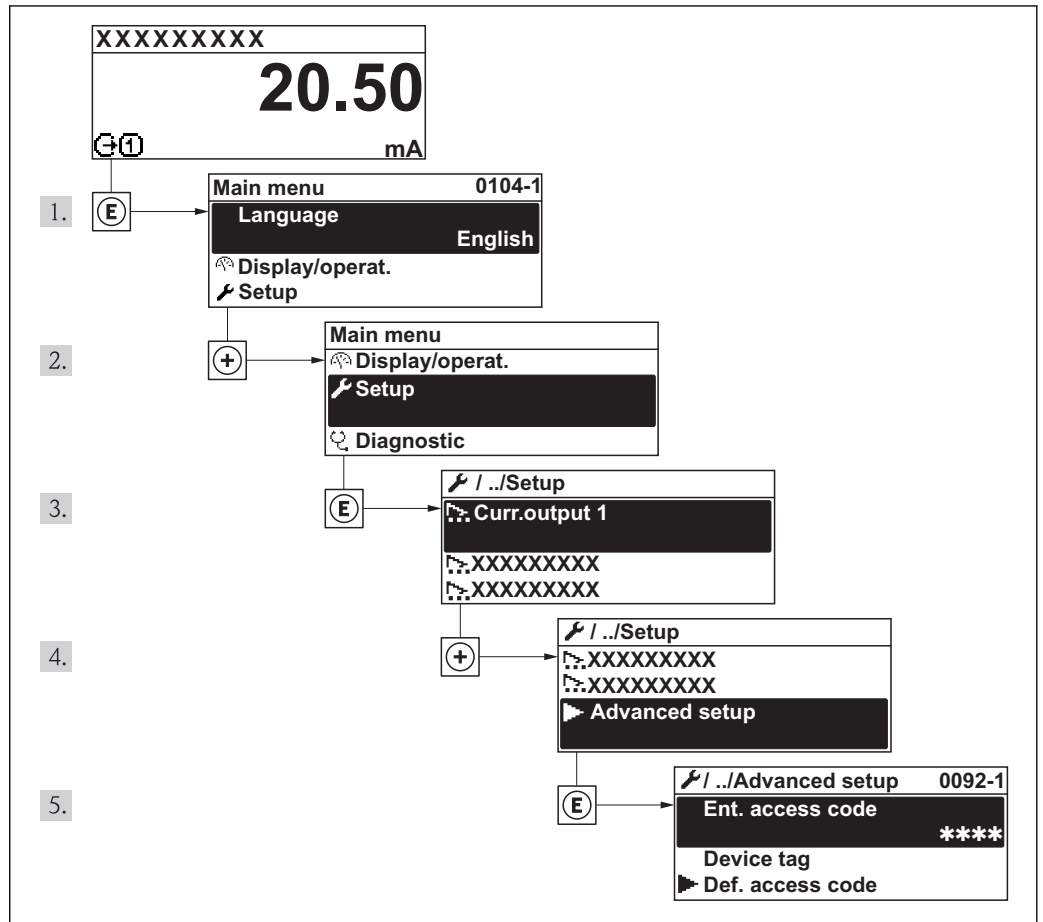

A0018745-EN

Functional Safety Manual with information on the SIL device → 138

For detailed information on the parameter descriptions of the **Heartbeat Verification** application package, see the Special Documentation for the device

Navigation

"Setup" menu → Advanced setup

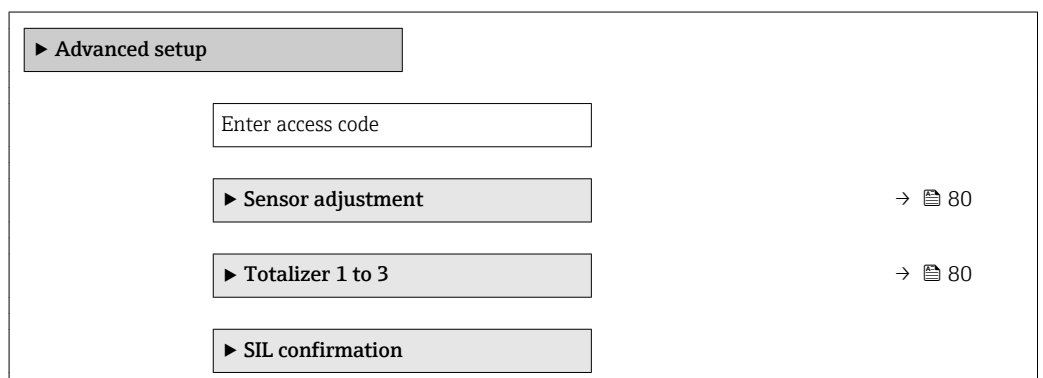

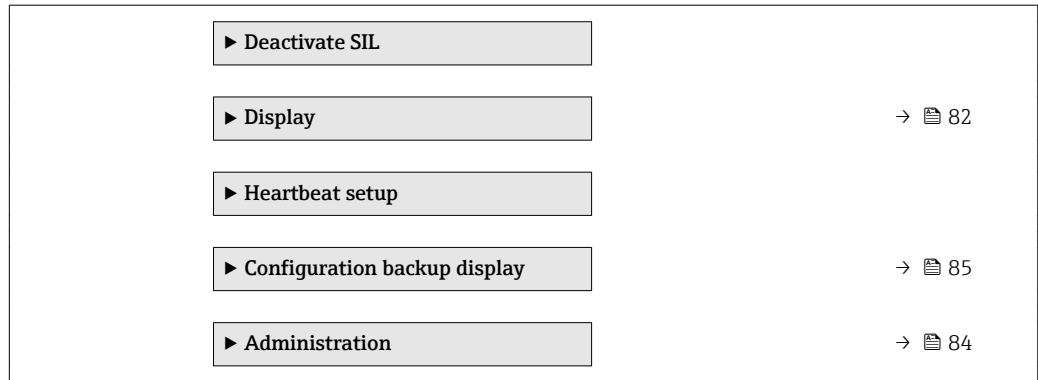

10.5.1 Carrying out a sensor adjustment

The **Sensor adjustment** submenu contains parameters that pertain to the functionality of the sensor.

Navigation

"Setup" menu → Advanced setup → Sensor adjustment

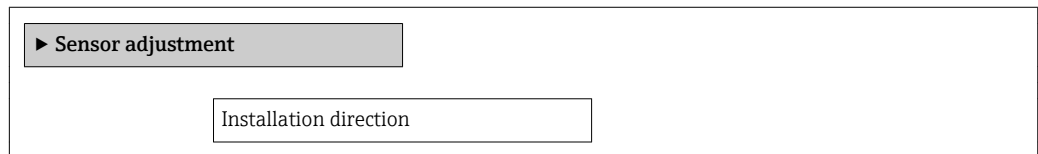

Parameter overview with brief description

Parameter	Description	Selection	Factory setting
Installation direction	Set sign of flow direction to match the direction of the arrow on the sensor.	<ul style="list-style-type: none"> ▪ Flow in arrow direction ▪ Flow against arrow direction 	Flow in arrow direction

10.5.2 Configuring the totalizer

In the **"Totalizer 1 to 3"** submenu the individual totalizer can be configured.

Navigation

"Setup" menu → Advanced setup → Totalizer 1 to 3

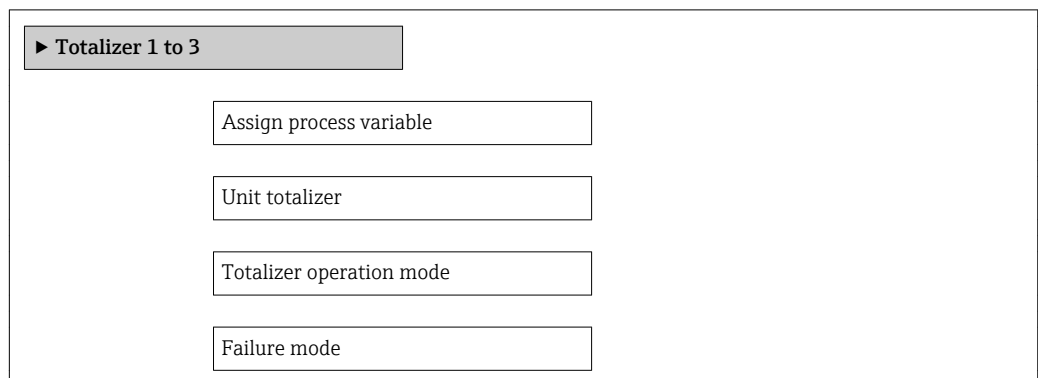

Parameter overview with brief description

Parameter	Description	Selection	Factory setting
Assign process variable	Select process variable for totalizer.	<ul style="list-style-type: none"> ▪ Off ▪ Volume flow ▪ Mass flow 	Volume flow
Unit totalizer	Select process variable totalizer unit.	Unit choose list	l
Totalizer operation mode	Select totalizer calculation mode.	<ul style="list-style-type: none"> ▪ Net flow total ▪ Forward flow total ▪ Reverse flow total 	Net flow total
Failure mode	Define totalizer behavior in alarm condition.	<ul style="list-style-type: none"> ▪ Stop ▪ Actual value ▪ Last valid value 	Stop

10.5.3 Carrying out additional display configurations

In the **Display** submenu you can set all the parameters associated with the configuration of the local display.

Navigation

"Setup" menu → Advanced setup → Display

► Display

- Format display
- Value 1 display
- 0% bargraph value 1
- 100% bargraph value 1
- Decimal places 1
- Value 2 display
- Decimal places 2
- Value 3 display
- 0% bargraph value 3
- 100% bargraph value 3
- Decimal places 3
- Value 4 display
- Decimal places 4
- Language
- Display interval
- Display damping
- Header
- Header text
- Separator
- Backlight

Parameter overview with brief description

Parameter	Prerequisite	Description	Selection / User entry	Factory setting
Format display	A local display is provided.	Select how measured values are shown on the display.	<ul style="list-style-type: none"> ■ 1 value, max. size ■ 1 bargraph + 1 value ■ 2 values ■ 1 value large + 2 values ■ 4 values 	1 value, max. size
Value 1 display	A local display is provided.	Select the measured value that is shown on the local display.	<ul style="list-style-type: none"> ■ Volume flow ■ Mass flow ■ Totalizer 1 ■ Totalizer 2 ■ Totalizer 3 ■ Current output 1 	Volume flow
0% bargraph value 1	A local display is provided.	Enter 0% value for bar graph display.	Signed floating-point number	0 l/h
100% bargraph value 1	A local display is provided.	Enter 100% value for bar graph display.	Signed floating-point number	Depends on country and nominal diameter
Decimal places 1	A measured value is specified in the Value 1 display parameter.	Select the number of decimal places for the display value.	<ul style="list-style-type: none"> ■ x ■ x.x ■ x.xx ■ x.xxx ■ x.xxxx 	x.xx
Value 2 display	A local display is provided.	Select the measured value that is shown on the local display.	Picklist (see Value 1 display)	None
Decimal places 2	A measured value is specified in the Value 2 display parameter.	Select the number of decimal places for the display value.	<ul style="list-style-type: none"> ■ x ■ x.x ■ x.xx ■ x.xxx ■ x.xxxx 	x.xx
Value 3 display	A local display is provided.	Select the measured value that is shown on the local display.	Picklist (see Value 1 display)	None
0% bargraph value 3	An option was selected in the Value 3 display parameter.	Enter 0% value for bar graph display.	Signed floating-point number	0
100% bargraph value 3	An option was selected in the Value 3 display parameter.	Enter 100% value for bar graph display.	Signed floating-point number	Depends on country and nominal diameter
Decimal places 3	A measured value is specified in the Value 3 display parameter.	Select the number of decimal places for the display value.	<ul style="list-style-type: none"> ■ x ■ x.x ■ x.xx ■ x.xxx ■ x.xxxx 	x.xx
Value 4 display	A local display is provided.	Select the measured value that is shown on the local display.	Picklist (see Value 1 display)	None
Decimal places 4	A measured value is specified in the Value 4 display parameter.	Select the number of decimal places for the display value.	<ul style="list-style-type: none"> ■ x ■ x.x ■ x.xx ■ x.xxx ■ x.xxxx 	x.xx

Parameter	Prerequisite	Description	Selection / User entry	Factory setting
Language	A local display is provided.	Set display language.	<ul style="list-style-type: none"> ▪ English ▪ Deutsch * ▪ Français * ▪ Español * ▪ Italiano * ▪ Nederlands * ▪ Portuguesa * ▪ Polski * ▪ русский язык (Russian) * ▪ Svenska * ▪ Türkçe * ▪ 中文 (Chinese) * ▪ 日本語 (Japanese) * ▪ 한국어 (Korean) * ▪ العربية (Arabic) * ▪ Bahasa Indonesia * ▪ ภาษาไทย (Thai) * ▪ tiếng Việt (Vietnamese) * ▪ čeština (Czech) * 	English (alternatively, the ordered language is preset in the device)
Display interval	A local display is provided.	Set time measured values are shown on display if display alternates between values.	1 to 10 s	5 s
Display damping	A local display is provided.	Set display reaction time to fluctuations in the measured value.	0.0 to 999.9 s	0.0 s
Header	A local display is provided.	Select header contents on local display.	<ul style="list-style-type: none"> ▪ Device tag ▪ Free text 	Device tag
Header text	The Free text option is selected in the Header parameter.	Enter display header text.	Max. 12 characters such as letters, numbers or special characters (e.g. @, %, /)	-----
Separator	A local display is provided.	Select decimal separator for displaying numerical values.	<ul style="list-style-type: none"> ▪ . ▪ , 	.
Backlight	–	Switch the local display backlight on and off.  Only for device version with onsite display SD03 (touch control)	<ul style="list-style-type: none"> ▪ Disable ▪ Enable 	Disable

* Visibility depends on order options or device settings

10.5.4 Administration configuration

The **Administration** submenu contains administrative parameters.

Navigation

"Setup" menu → Advanced setup → Administration

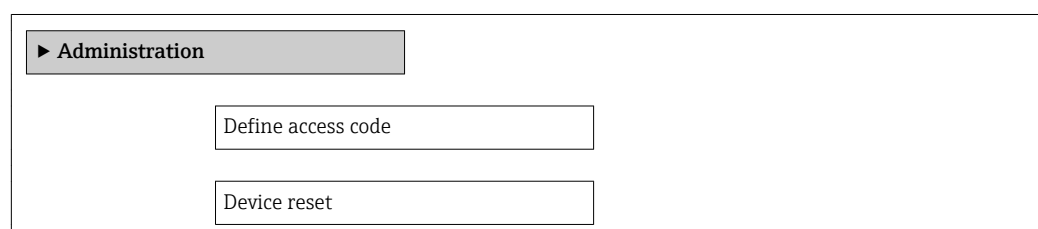

Parameter overview with brief description

Parameter	Description	User entry / Selection	Factory setting
Define access code	Restrict write-access to parameters to protect the configuration of the device against unintentional changes via the local display.	0 to 9 999	0
Device reset	Restart or reset device manually.	<ul style="list-style-type: none"> ■ Cancel ■ To factory defaults ■ To delivery settings ■ Restart device 	Cancel

10.6 Configuration management

After commissioning, you can save the current device configuration, copy it to another measuring point or restore the previous device configuration.

You can do so using the **Configuration management** parameter and the related options found in the **Configuration backup display** submenu.

Navigation

"Setup" menu → Advanced setup → Configuration backup display

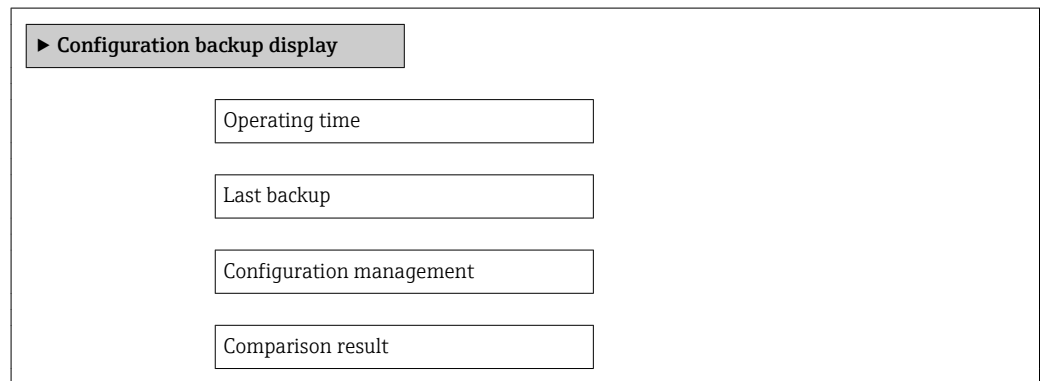

Parameter overview with brief description

Parameter	Prerequisite	Description	User interface / Selection	Factory setting
Operating time	–	Indicates how long the device has been in operation.	Days (d), hours (h), minutes (m), seconds (s)	–
Last backup	–	Indicates when the last data backup was saved to the display module.	Days (d), hours (h), minutes (m), seconds (s)	–

Parameter	Prerequisite	Description	User interface / Selection	Factory setting
Configuration management	A local display is provided.	Select action for managing the device data in the display module.	<ul style="list-style-type: none"> ▪ Cancel ▪ Execute backup ▪ Restore ▪ Duplicate ▪ Compare ▪ Clear backup data 	Cancel
Comparison result	–	Comparison between present device data and display backup.	<ul style="list-style-type: none"> ▪ Settings identical ▪ Settings not identical ▪ No backup available ▪ Backup settings corrupt ▪ Check not done ▪ Dataset incompatible 	Check not done

10.6.1 Function range of "Configuration management" parameter

Options	Description
Execute backup	The current device configuration is backed up from the integrated HistoROM to the device's display module. The backup copy includes the transmitter data of the device.
Restore	The last backup copy of the device configuration is restored from the display module to the device's integrated HistoROM. The backup copy includes the transmitter data of the device.
Duplicate	The transmitter configuration from another device is duplicated to the device using the display module.
Compare	The device configuration saved in the display module is compared with the current device configuration of the integrated HistoROM.
Clear backup data	The backup copy of the device configuration is deleted from the display module of the device.

 **Integrated HistoROM**
 A HistoROM is a "non-volatile" device memory in the form of an EEPROM.



 While this action is in progress, the configuration cannot be edited via the local display and a message on the processing status appears on the display.











10.7 Simulation

The **Simulation** submenu enables you to simulate, without a real flow situation, various process variables in the process and the device alarm mode and to verify downstream signal chains (switching valves or closed-control loops).



Navigation

"Diagnostics" menu → Simulation

▶ Simulation	
Assign simulation process variable	→  87
Process variable value	→  87

Simulation current output 1	→  87
Value current output 1	→  87
Frequency output simulation	→  87
Frequency value	→  87
Pulse output simulation	→  87
Pulse value	→  87
Switch output simulation	→  88
Switch status	→  88
Simulation device alarm	→  88
Diagnostic event category	→  88
Diagnostic event simulation	→  88

Parameter overview with brief description

Parameter	Prerequisite	Description	Selection / User entry	Factory setting
Assign simulation process variable	–	Select a process variable for the simulation process that is activated.	<ul style="list-style-type: none"> ■ Off ■ Volume flow ■ Mass flow 	Off
Process variable value	A process variable is selected in the Assign simulation process variable parameter.	Enter the simulation value for the selected process variable.	Signed floating-point number	0
Simulation current output 1	–	Switch the simulation of the current output on and off.	<ul style="list-style-type: none"> ■ Off ■ On 	Off
Value current output 1	The On option is selected in the Simulation current output 1 parameter (→  87).	Enter the current value for simulation.	3.59 to 22.5 mA	–
Frequency output simulation	–	Switch simulation of the frequency output on and off.	<ul style="list-style-type: none"> ■ Off ■ On 	Off
Frequency value	The On option is selected in the Frequency output simulation parameter.	Enter the frequency value for simulation.	0.0 to 1250.0 Hz	0.0 Hz
Pulse output simulation	The Down-count. val. option is selected in the Simulation pulse output parameter.	Switch simulation of the pulse output on and off.  If the Fixed value option is selected, the Pulse width parameter defines the pulse width of the pulses output.	<ul style="list-style-type: none"> ■ Off ■ Fixed value ■ Down-counting value 	Off
Pulse value	The Down-count. val. option is selected in the Simulation pulse output parameter.	Enter the number of pulses for simulation.	0 to 65535	0

Parameter	Prerequisite	Description	Selection / User entry	Factory setting
Switch output simulation	–	Switch simulation of switch output on and off.	<ul style="list-style-type: none"> ▪ Off ▪ On 	Off
Switch status	The On option is selected in the Switch output simulation parameter.	Select the status of the status output for the simulation.	<ul style="list-style-type: none"> ▪ Open ▪ Closed 	Open
Simulation device alarm	–	Switch the device alarm on and off.	<ul style="list-style-type: none"> ▪ Off ▪ On 	Off
Diagnostic event category	–	Select the category of the diagnostic event.	<ul style="list-style-type: none"> ▪ Sensor ▪ Electronics ▪ Configuration ▪ Process 	Process
Diagnostic event simulation	–	Switch simulation of the diagnostic event on and off. For the simulation, you can choose from the diagnostic events of the category selected in the Diagnostic event category parameter.	<ul style="list-style-type: none"> ▪ Off ▪ Picklist Diagnostic events (depends on the selected category) 	Off

10.8 Protecting settings from unauthorized access

The following options exist for protecting the configuration of the measuring device from unintentional modification after commissioning:

- Write protection via access code
- Write protection via write protection switch
- Write protection via keypad lock →  51

10.8.1 Write protection via access code

With the customer-specific access code, the parameters for the measuring device configuration are write-protected and their values can no longer be changed via local operation.

Navigation

"Setup" menu → Advanced setup → Administration → Define access code

▶ Define access code

Defining the access code via local display

1. Navigate to the **Enter access code** parameter.
2. Max. Define a max. 4-digit numeric code as an access code.
3. Enter the access code again to confirm the code.
 - ↳ The -symbol appears in front of all write-protected parameters.

The device automatically locks the write-protected parameters again if a key is not pressed for 10 minutes in the navigation and editing view. The device locks the write-protected

parameters automatically after 60 s if the user skips back to the operational display mode from the navigation and editing view.

- i
 - If write access is activated via access code, it can be also be deactivated only via the access code → 51.
 - The user role with which the user is currently logged on via the local display → 51 is indicated by the **Access status display** parameter. Navigation path: "Operation" menu → Access status display

Parameters which can always be modified via the local display

Certain parameters that do not affect the measurement are excepted from write protection via the local display. Despite the defined access code, these parameters can always be modified even if the other parameters are locked.

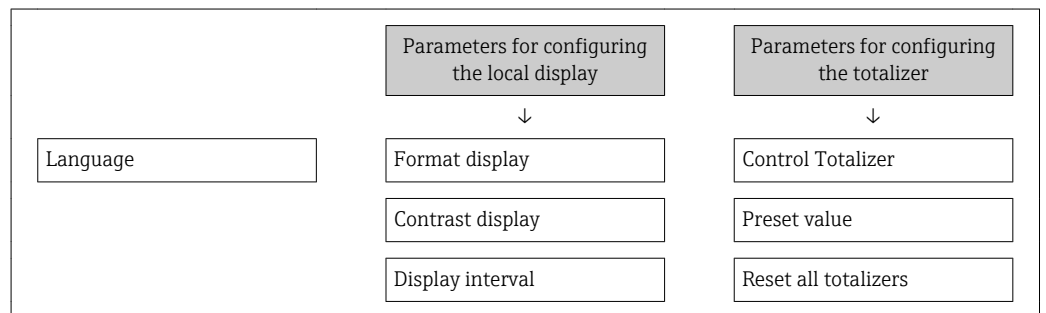

10.8.2 Write protection via write protection switch

Unlike write protection via a user-specific access code, this allows write access to the entire operating menu - other than the **"Contrast display" parameter** - to be locked.

The parameter values are now read only and cannot be edited any more (exception **"Contrast display" parameter**):

- Via local display
- Via service interface (CDI)
- Via HART protocol

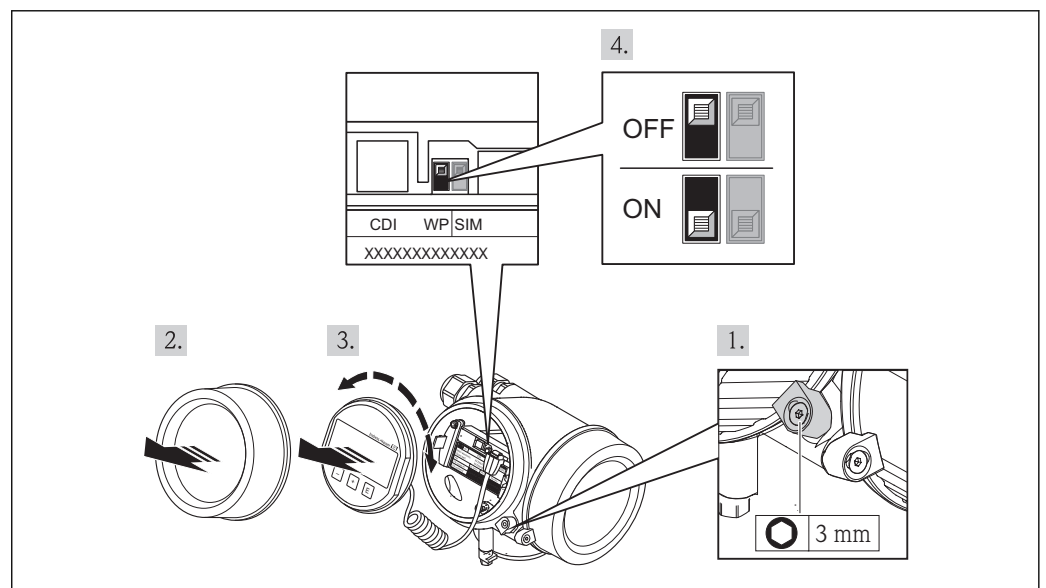

1. Loosen the securing clamp.
2. Unscrew the electronics compartment cover.

3. Pull out the display module with a gentle rotational movement. To make it easier to access the lock switch, attach the display module to the edge of the electronics compartment.
 - ↳ Display module is attached to the edge of the electronics compartment.

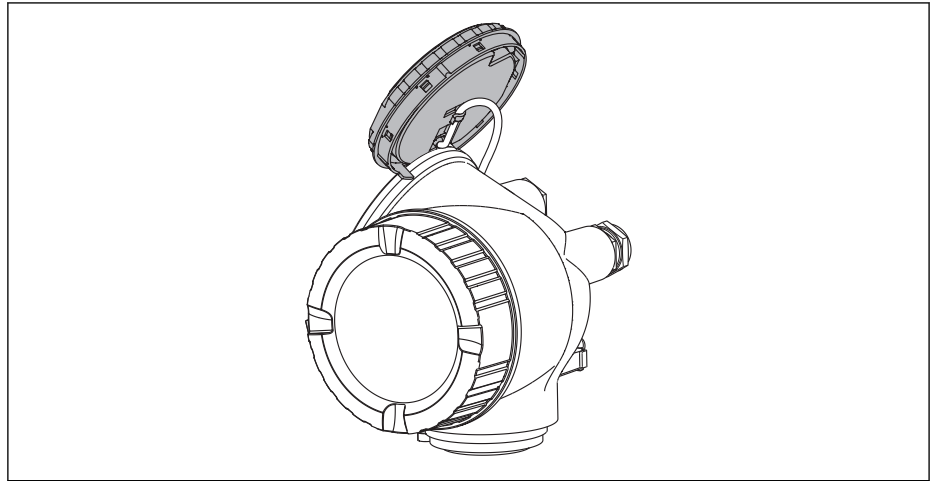

A0013909

4. Setting the write protection switch (WP) on the main electronics module to the **ON** position enables hardware write protection. Setting the write protection switch (WP) on the main electronics module to the **OFF** position (factory setting) disables hardware write protection.
 - ↳ If hardware write protection is enabled, the **Locking status** parameter displays the **Hardware locked** option . In addition, on the local display the -symbol appears in front of the parameters in the header of the operational display and in the navigation view.

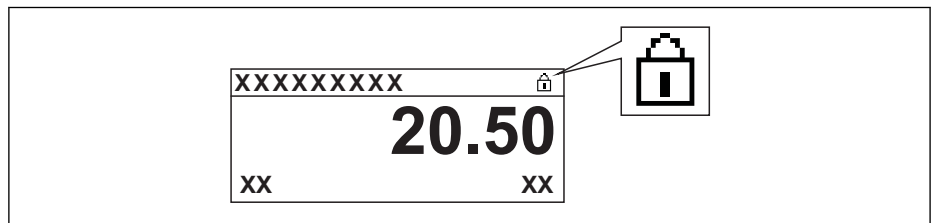

A0015870

If hardware write protection is disabled, no option is displayed in the **Locking status** parameter . On the local display, the -symbol disappears from in front of the parameters in the header of the operational display and in the navigation view.

5. Feed the cable into the gap between the housing and main electronics module and plug the display module into the electronics compartment in the desired direction until it engages.
6. Reverse the removal procedure to reassemble the transmitter.

11 Operation

11.1 Reading the device locking status

The write protection types that are currently active can be determined using the **Locking status** parameter.

Navigation



"Operation" menu → Locking status

Function scope of "Locking status" parameter



Options	Description
None	The access status displayed in " Access status display " parameter applies →  51. Only appears on local display.
Hardware locked	The DIP switch for hardware locking is activated on the main electronics module. This locks write access to the parameters .
Temporarily locked	Write access to the parameters is temporarily lock due to device-internal processing (e.g. data upload/download, reset). Once the internal processing has been completed, the parameters can be changed once again.

11.2 Adjusting the operating language

Information →  61

 For information on the operating languages supported by the measuring device →  135

11.3 Configuring the display

- Basic settings for local display →  73
- Advanced settings for local display →  82

11.4 Reading measured values

With the **Measured values** submenu, it is possible to read all the measured values.

11.4.1 Process variables

The **Process variables** submenu contains all the parameters needed to display the current measured values for every process variable.

Navigation

"Diagnostics" menu → Measured values → Process variables

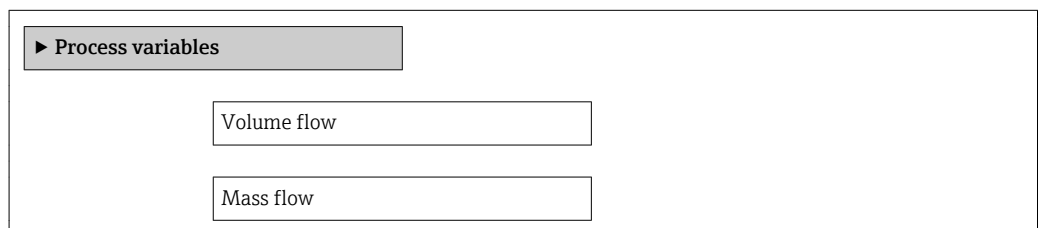

Parameter overview with brief description

Parameter	Description	User interface
Volume flow	Displays the volume flow currently measured.	Signed floating-point number
Mass flow	Displays the mass flow currently calculated.	Signed floating-point number

11.4.2 Totalizer

The **Totalizer** submenu contains all the parameters needed to display the current measured values for every totalizer.

Navigation

"Diagnostics" menu → Measured values → Totalizer

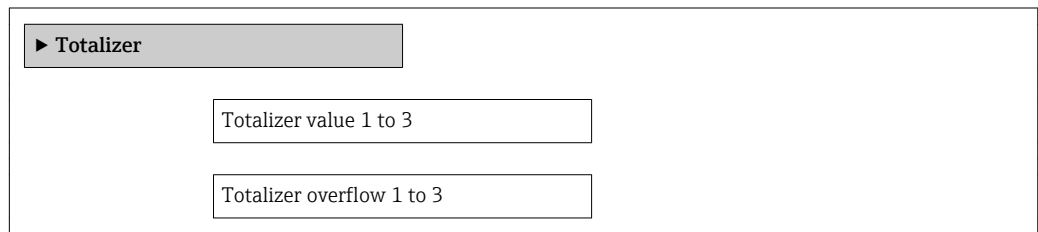

Parameter overview with brief description

Parameter	Prerequisite	Description	User interface	Factory setting
Totalizer value 1 to 3	In the Assign process variable parameter in the Totalizer 1 to 3 submenu, one of the following options is selected: <ul style="list-style-type: none"> ▪ Volume flow ▪ Mass flow 	Displays the current totalizer counter value.	Signed floating-point number	0 l
Totalizer overflow 1 to 3	In the Assign process variable parameter in the Totalizer 1 to 3 submenu, one of the following options is selected: <ul style="list-style-type: none"> ▪ Volume flow ▪ Mass flow 	Displays the current totalizer overflow.	Integer with sign	0

11.4.3 Output values

The **Output values** submenu contains all the parameters needed to display the current measured values for every output.

Navigation

"Diagnostics" menu → Measured values → Output values

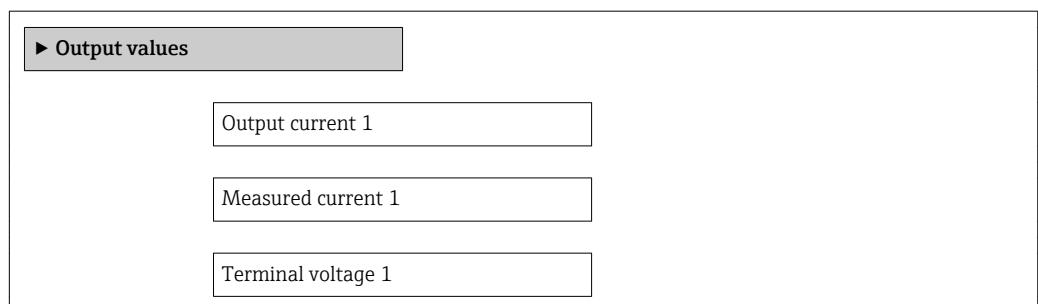

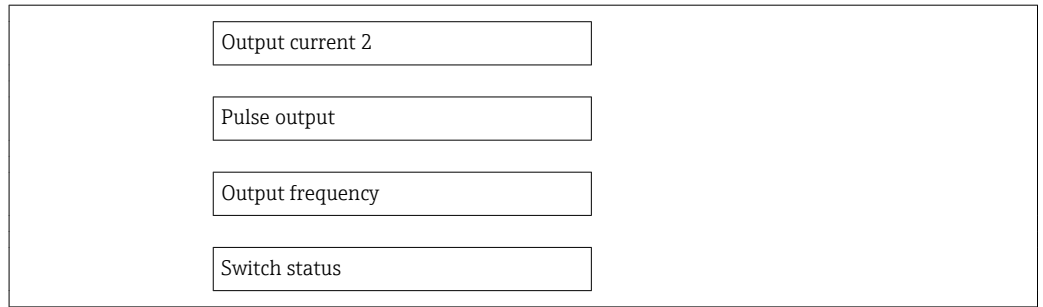

Parameter overview with brief description

Parameter	Description	User interface	Factory setting
Output current 1	Displays the current value currently calculated for the current output.	3.59 to 22.5 mA	3.59 mA
Measured current 1	Displays the current value currently measured for the current output.	0 to 30 mA	0 mA
Terminal voltage 1	Displays the current terminal voltage that is applied at the current output.	0.0 to 50.0 V	0 V
Output current 2	Displays the current value currently calculated for the current output.	3.59 to 22.5 mA	3.59 mA
Pulse output	Displays the value currently measured for the pulse output.	Positive floating-point number	0 Hz
Output frequency	Displays the value currently measured for the frequency output.	0.0 to 1250.0 Hz	0.0 Hz
Switch status	Displays the current switch output status.	<ul style="list-style-type: none"> ■ Open ■ Closed 	Open

11.5 Adapting the measuring device to the process conditions

The following are available for this purpose:

- Basic settings using the **Setup** menu
- Advanced settings using the **Advanced setup** submenu

11.6 Performing a totalizer reset

In the **Operation** submenu the totalizers are reset:

- Control Totalizer
- Reset all totalizers

Function scope of "Control Totalizer" parameter

Options	Description
Totalize	The totalizer is started.
Reset + hold	The totaling process is stopped and the totalizer is reset to 0.
Preset + hold	The totaling process is stopped and the totalizer is set to its defined start value from the Preset value parameter.
Reset + totalize	The totalizer is reset to 0 and the totaling process is restarted.
Preset + totalize	The totalizer is set to the defined start value in Preset value parameter and the totaling process is restarted.

Function scope of "Reset all totalizers" parameter

Options	Description
Reset + totalize	Resets all totalizers to 0 and restarts the totaling process. This deletes all the flow values previously totalized.

Navigation

"Operation" menu → Operation

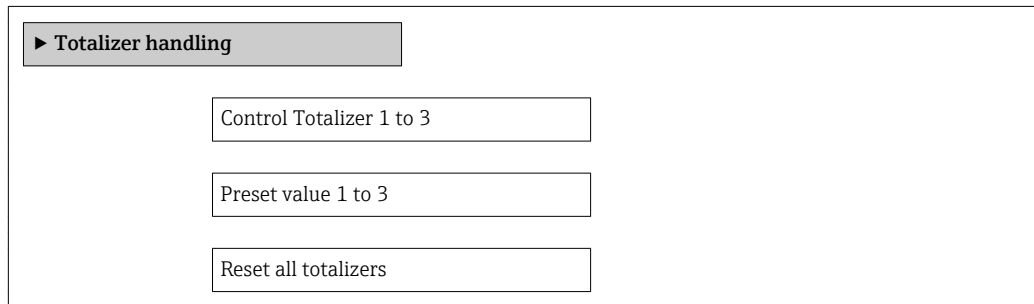

Parameter overview with brief description

Parameter	Description	Selection / User entry	Factory setting
Control Totalizer 1 to 3	Control totalizer value.	<ul style="list-style-type: none"> Totalize Reset + hold Preset + hold Reset + totalize Preset + totalize 	Totalize
Preset value 1 to 3	Specify start value for totalizer.	Signed floating-point number	01
Reset all totalizers	Reset all totalizers to 0 and start.	<ul style="list-style-type: none"> Cancel Reset + totalize 	Cancel

11.7 Showing data logging

The **Extended HistoROM** application package (order option) must be enabled in the device for the **Data logging** submenu to appear. This contains all the parameters for the measured value history.

 The data logging history is also available via the FieldCare plant asset management tool →  54.

Function scope

- A total of 1000 measured values can be stored
- 4 logging channels
- Adjustable logging interval for data logging
- Display of the measured value trend for each logging channel in the form of a chart

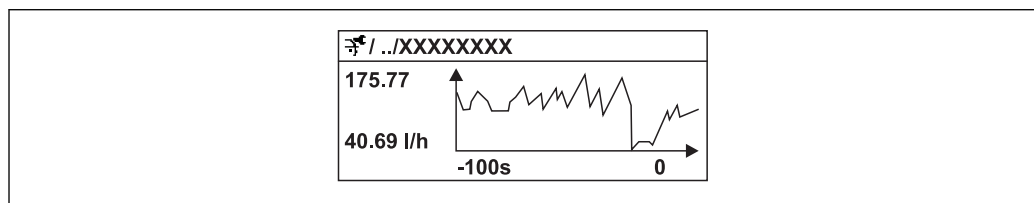

 28 Chart of a measured value trend

A0016222

- x-axis: depending on the number of channels selected displays 250 to 1000 measured values of a process variable.
- y-axis: displays the approximate measured value span and constantly adapts this to the ongoing measurement.

 If the length of the logging interval or the assignment of the process variables to the channels is changed, the content of the data logging is deleted.

Navigation

"Diagnostics" menu → Data logging

"Data logging" submenu

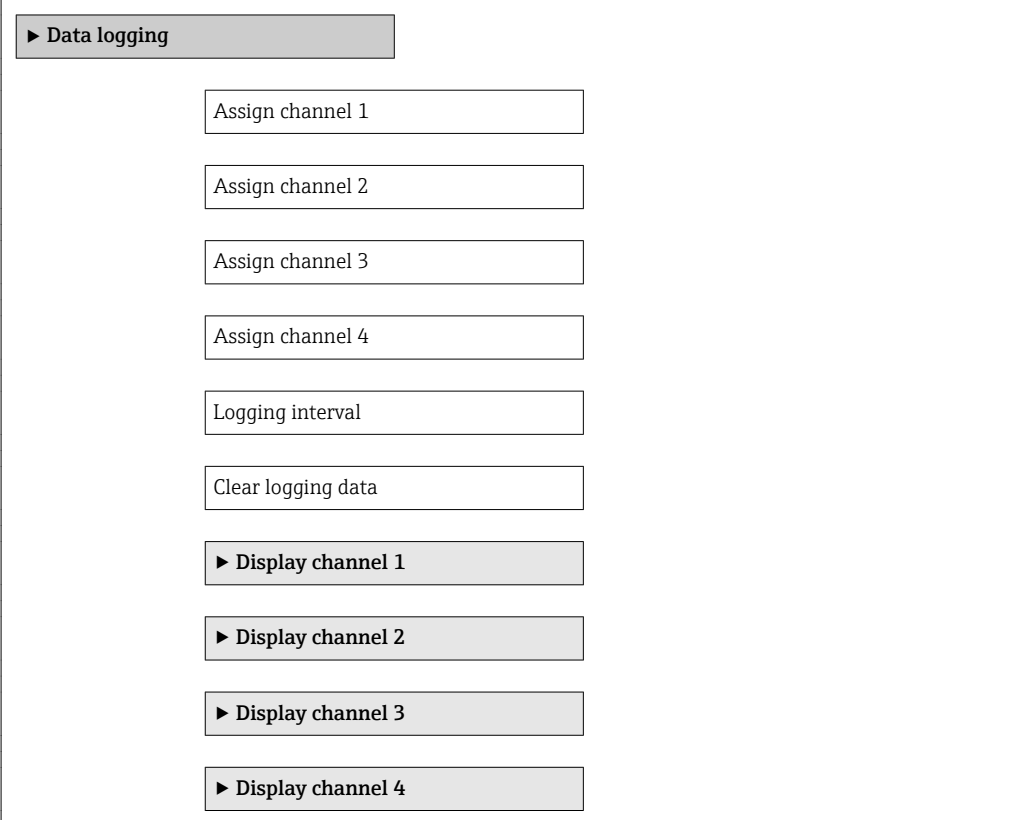

► Data logging

Assign channel 1

Assign channel 2

Assign channel 3

Assign channel 4

Logging interval

Clear logging data



► Display channel 1

► Display channel 2

► Display channel 3

► Display channel 4

Parameter overview with brief description

Parameter	Prerequisite	Description	Selection / User entry	Factory setting
Assign channel 1 to 4	The Extended HistoROM application package is available.  The software options currently enabled are displayed in the Software option overview parameter.	Assign process variable to logging channel.	<ul style="list-style-type: none"> ▪ Off ▪ Volume flow ▪ Mass flow ▪ Electronic temperature ▪ Current output 1 ▪ Current difference potential 	Off
Logging interval	The Extended HistoROM application package is available.  The software options currently enabled are displayed in the Software option overview parameter.	Define the logging interval for data logging. This value defines the time interval between the individual data points in the memory.	1.0 to 3 600.0 s	10.0 s
Clear logging data	The Extended HistoROM application package is available.  The software options currently enabled are displayed in the Software option overview parameter.	Clear the entire logging data.	<ul style="list-style-type: none"> ▪ Cancel ▪ Clear data 	Cancel

12 Diagnostics and troubleshooting

12.1 General troubleshooting





For local display

Problem	Possible causes	Remedial action
Local display dark and no output signals	Supply voltage does not match that specified on the nameplate.	Apply the correct supply voltage .
Local display dark and no output signals	Supply voltage has incorrect polarity.	Reverse polarity of supply voltage.
Local display dark and no output signals	No contact between connecting cables and terminals.	Check the connection of the cables and correct if necessary.
Local display dark and no output signals	Terminals are not plugged into the I/O electronics module correctly.	Check terminals.
Local display dark and no output signals	I/O electronics module is defective.	Order spare part → ☎ 114.
Local display is dark, but signal output is within the valid range	Display is set too bright or too dark.	<ul style="list-style-type: none"> ▪ Set the display brighter by simultaneously pressing + . ▪ Set the display darker by simultaneously pressing + .
Local display is dark, but signal output is within the valid range	The cable of the display module is not plugged in correctly.	Insert the plug correctly into the main electronics module and display module.
Local display is dark, but signal output is within the valid range	Display module is defective.	Order spare part → ☎ 114.
Backlighting of local display is red	Diagnostic event with "Alarm" diagnostic behavior has occurred.	Take remedial measures → ☎ 104
Text on local display appears in a foreign language and cannot be understood.	Incorrect operating language is configured.	<ol style="list-style-type: none"> 1. Press + for 2 s ("home position"). 2. Press . 3. Set the desired language in the Language parameter.
Message on local display: "Communication Error" "Check Electronics"	Communication between the display module and the electronics is interrupted.	<ul style="list-style-type: none"> ▪ Check the cable and the connector between the main electronics module and display module. ▪ Order spare part → ☎ 114.

For output signals

Problem	Possible causes	Remedial action
Signal output outside the valid range	Main electronics module is defective.	Order spare part → ☎ 114.
Signal output outside the valid current range (< 3.6 mA or > 22 mA)	I/O electronics module is defective.	Order spare part → ☎ 114.
Device shows correct value on local display, but signal output is incorrect, though in the valid range.	Configuration error	Check and correct parameter configuration.
Device measures incorrectly.	Configuration error or device is operated outside the application.	<ol style="list-style-type: none"> 1. Check and correct parameter configuration. 2. Observe limit values specified in the "Technical Data".

For access

Problem	Possible causes	Remedial action
No write access to parameters	Hardware write protection enabled	Set the write protection switch on the main electronics module to the OFF position .
No write access to parameters	Current user role has limited access authorization	1. Check user role →  51. 2. Enter correct customer-specific access code →  51.
No connection via HART protocol	Missing or incorrectly installed communication resistor.	Install the communication resistor (250 Ω) correctly. Observe the maximum load →  30.
No connection via HART protocol	Commubox <ul style="list-style-type: none"> ▪ Connected incorrectly ▪ Configured incorrectly ▪ Drivers not installed correctly ▪ USB interface on computer configured incorrectly 	Observe the documentation for the Commubox.  FXA195 HART: Document "Technical Information" TI00404F
No connection via service interface	Incorrect configuration of USB interface on PC or driver not installed correctly.	Observe the documentation for the Commubox.  FXA291: Document "Technical Information" TI00405C

12.2 Diagnostic information on local display

12.2.1 Diagnostic message

Faults detected by the self-monitoring system of the measuring device are displayed as a diagnostic message in alternation with the operational display.

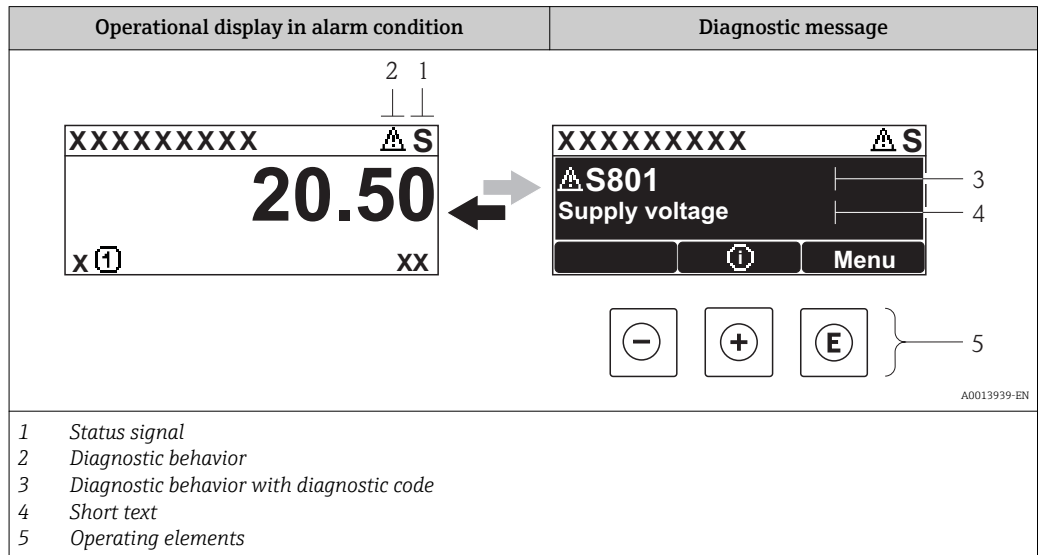

If two or more diagnostic events are pending simultaneously, only the message of the diagnostic event with the highest priority is shown.

- i** Other diagnostic events that have occurred can be called up in the **Diagnostics** menu:
 - Via parameters → 106
 - Via submenus → 107



Status signals

The status signals provide information on the state and reliability of the device by categorizing the cause of the diagnostic information (diagnostic event).

- i** The status signals are categorized according to VDI/VDE 2650 and NAMUR Recommendation NE 107: F = Failure, C = Function Check, S = Out of Specification, M = Maintenance Required

Symbol	Meaning
F <small>A0013956</small>	Failure A device error has occurred. The measured value is no longer valid.
C <small>A0013959</small>	Function check The device is in service mode (e.g. during a simulation).
S <small>A0013958</small>	Out of specification The device is operated: <ul style="list-style-type: none"> ▪ Outside its technical specification limits (e.g. outside the process temperature range) ▪ Outside of the configuration carried out by the user (e.g. maximum flow in parameter 20 mA value)
M <small>A0013957</small>	Maintenance required Maintenance is required. The measured value remains valid.

Diagnostic behavior



Symbol	Meaning
 <small>A0013961</small>	Alarm <ul style="list-style-type: none"> ▪ Measurement is interrupted. ▪ Signal outputs and totalizers assume the defined alarm condition. ▪ A diagnostic message is generated. ▪ For local display with touch control: the background lighting changes to red.
 <small>A0013962</small>	Warning Measurement is resumed. The signal outputs and totalizers are not affected. A diagnostic message is generated.

Diagnostic information

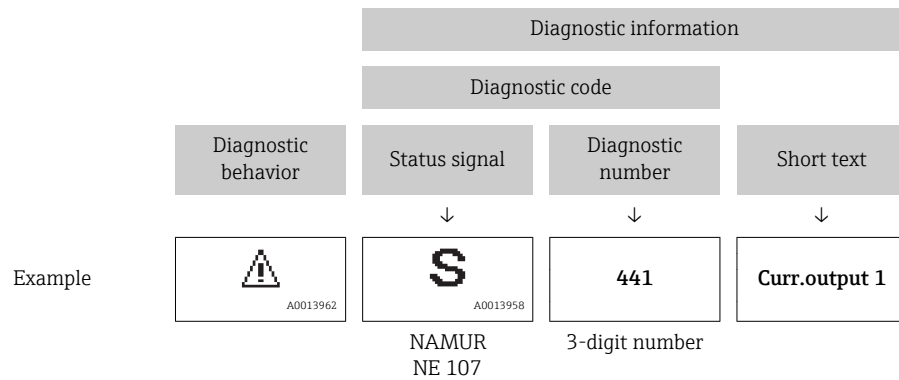
The fault can be identified using the diagnostic information. The short text helps you by providing information about the fault. In addition, the corresponding symbol for the diagnostic behavior is displayed in front of the diagnostic information on the local display.



Operating elements

Key	Meaning
 <small>A0013970</small>	Plus key <i>In a menu, submenu</i> Opens the message about the remedial measures.
 <small>A0013952</small>	Enter key <i>In a menu, submenu</i> Opens the operating menu.

12.2.2 Calling up remedial measures

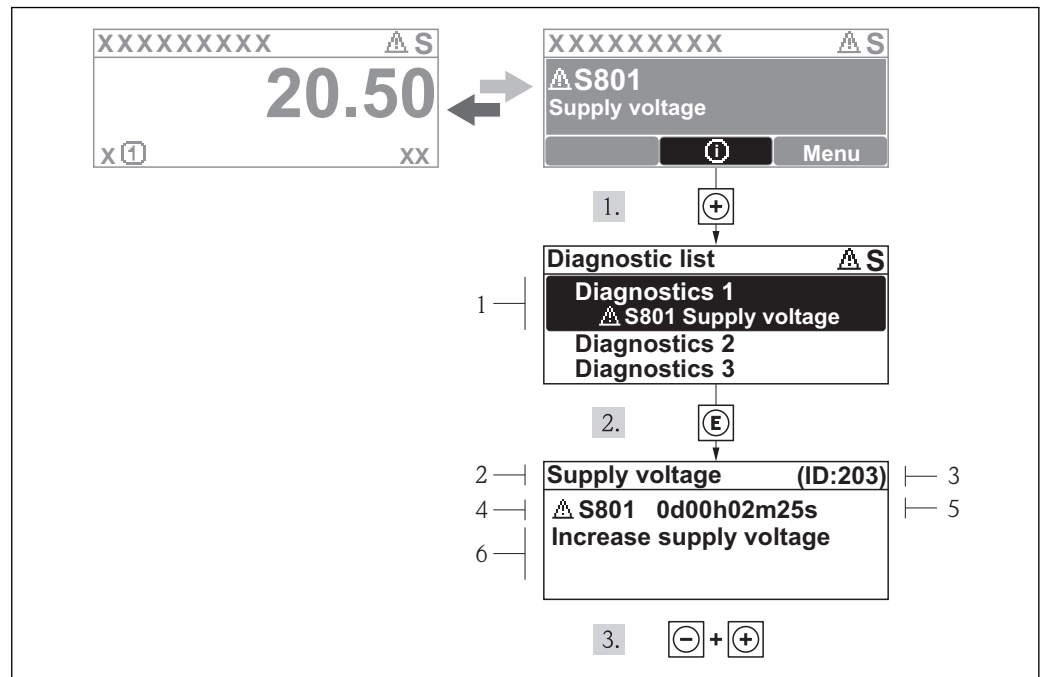

29 Message for remedial measures

- 1 Diagnostic information
- 2 Short text
- 3 Service ID
- 4 Diagnostic behavior with diagnostic code
- 5 Operation time of occurrence
- 6 Remedial measures

The user is in the diagnostic message.

1. Press ⊕ (⊕ symbol).
↳ The **Diagnostic list** submenu opens.
2. Select the desired diagnostic event with ⊕ or ⊖ and press ⏎ .
↳ The message for the remedial measures for the selected diagnostic event opens.
3. Press ⊖ + ⊕ simultaneously.
↳ The message for the remedial measures closes.

The user is in the **Diagnostics** menu at an entry for a diagnostics event, e.g. in the **Diagnostic list** submenu or the **Previous diagnostics** parameter.

1. Press ⏎ .
↳ The message for the remedial measures for the selected diagnostic event opens.
2. Press ⊖ + ⊕ simultaneously.
↳ The message for the remedial measures closes.

12.3 Diagnostic information in FieldCare

12.3.1 Diagnostic options

Any faults detected by the measuring device are displayed on the home page of the operating tool once the connection has been established.

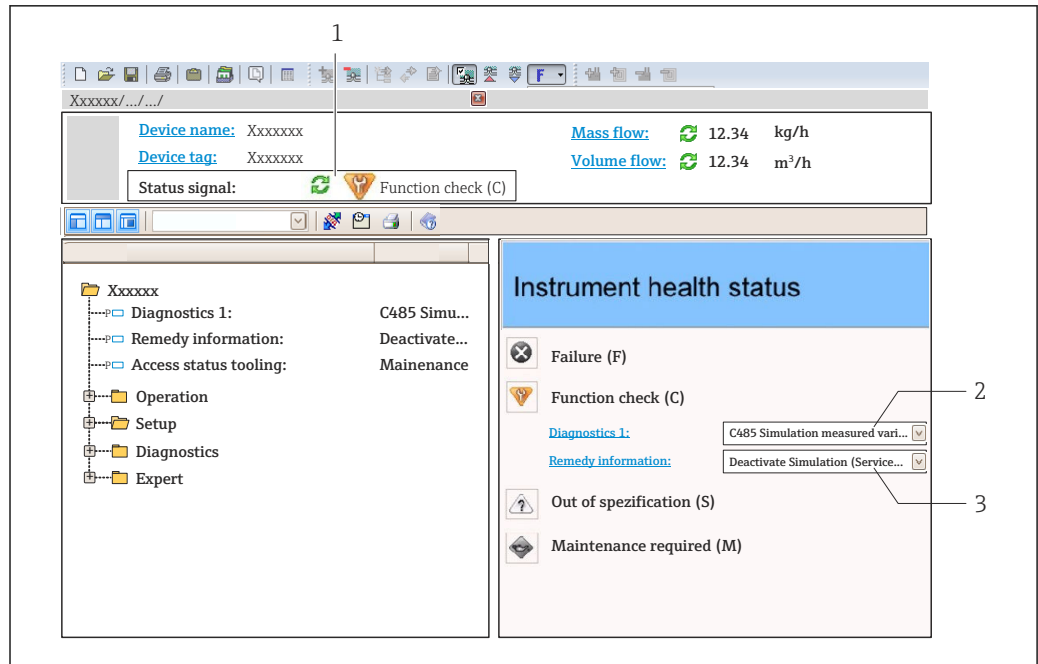

- 1 Status area with status signal → 99
- 2 Diagnostic information → 100
- 3 Remedial measures with Service ID

i Furthermore, diagnostic events that have occurred can be viewed in the **Diagnostics** menu:

- Via parameters → 106
- Via submenu → 107

Diagnostic information

The fault can be identified using the diagnostic information. The short text helps you by providing information about the fault. In addition, the corresponding symbol for the diagnostic behavior is displayed in front of the diagnostic information on the local display.

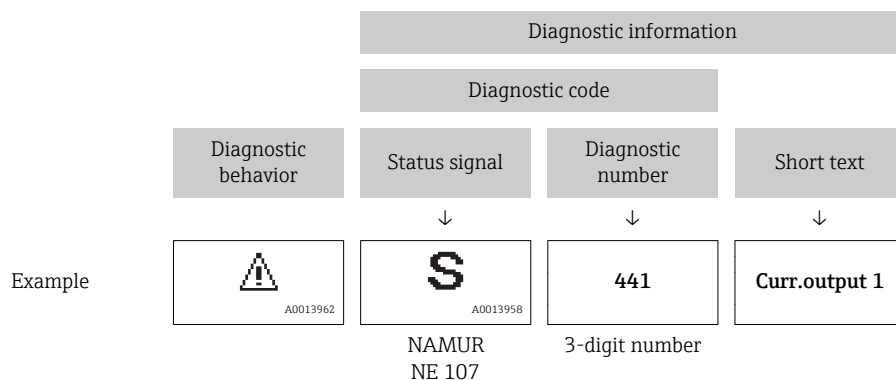

12.3.2 Calling up remedy information

Remedy information is provided for every diagnostic event to ensure that problems can be rectified quickly:

- On the home page
Remedy information is displayed in a separate field below the diagnostics information.
- In the **Diagnostics** menu
Remedy information can be called up in the working area of the user interface.

The user is in the **Diagnostics** menu.

1. Call up the desired parameter.
2. On the right in the working area, mouse over the parameter.
 - ↳ A tool tip with remedy information for the diagnostic event appears.

12.4 Adapting the diagnostic information

12.4.1 Adapting the diagnostic behavior

Each item of diagnostic information is assigned a specific diagnostic behavior at the factory. The user can change this assignment for certain diagnostic information in the **Diagnostic behavior** submenu .

"Expert" menu → System → Diagnostic handling → Diagnostic behavior

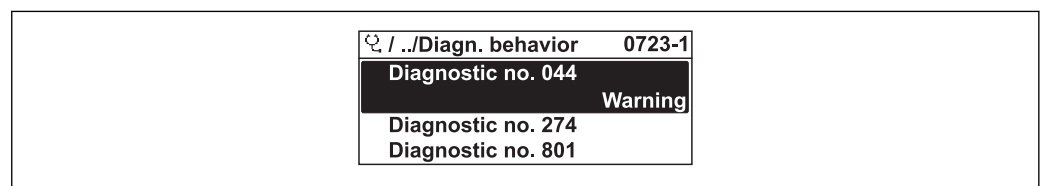

A0014048-EN

30 Using the example of the local display

You can assign the following options to the diagnostic number as the diagnostic behavior:

Options	Description
Alarm	Measurement is interrupted. Signal outputs and totalizers assume the defined alarm condition. A diagnostic message is generated. For local display with touch control: the background lighting changes to red.
Warning	Measurement is resumed. The signal outputs and totalizers are not affected. A diagnostics message is generated.
Logbook entry only	The device continues to measure. The diagnostic message is entered in the Event logbook (events list) submenu only and is not displayed in alternation with the measured value display.
Off	The diagnostic event is ignored, and no diagnostic message is generated or entered.

12.4.2 Adapting the status signal

Each item of diagnostic information is assigned a specific status signal at the factory. The user can change this assignment for certain diagnostic information in the **Diagnostic event category** submenu .

"Expert" menu → Communication → Diagnostic event category

Available status signals

Configuration as per HART 7 Specification (Condensed Status), in accordance with NAMUR NE107.

Symbol	Meaning
F <small>A0013956</small>	Failure A device error has occurred. The measured value is no longer valid.
C <small>A0013959</small>	Function check The device is in service mode (e.g. during a simulation).

Symbol	Meaning
S A0013958	Out of specification The device is operated: <ul style="list-style-type: none"> Outside its technical specification limits (e.g. outside the process temperature range) Outside of the configuration carried out by the user (e.g. maximum flow in parameter 20 mA value)
M A0013957	Maintenance required Maintenance is required. The measured value remains valid.
N A0023076	Has no effect on the condensed status.

12.5 Overview of diagnostic information

 The amount of diagnostic information and the number of measured variables affected increase if the measuring device has one or more application packages.



 In the case of some items of diagnostic information, the status signal and the diagnostic behavior can be changed. Change the diagnostic information →  103

Diagnostic number	Short text	Remedy instructions	Status signal [from the factory]	Diagnostic behavior [from the factory]
Diagnostic of sensor				
004	Sensor	1. Change sensor 2. Contact service	S	Warning ¹⁾
082	Data storage	1. Change main electronic module 2. Change sensor	F	Alarm
083	Memory content	1. Restart device 2. Restore S-Dat data 3. Change sensor	F	Alarm
Diagnostic of electronic				
222	Electronic drift	Change main electronic module	F	Alarm
242	Software incompatible	1. Check software 2. Flash or change main electronics module	F	Alarm
252	Modules incompatible	1. Check electronic modules 2. Change I/O or main electronic module	F	Alarm
261	Electronic modules	1. Restart device 2. Check electronic modules 3. Change I/O Modul or main electronics	F	Alarm
262	Module connection	1. Check module connections 2. Change electronic modules	F	Alarm
270	Main electronic failure	Change main electronic module	F	Alarm
271	Main electronic failure	1. Restart device 2. Change main electronic module	F	Alarm
272	Main electronic failure	1. Restart device 2. Contact service	F	Alarm
273	Main electronic failure	1. Emergency operation via display 2. Change main electronics	F	Alarm
275	I/O module failure	Change I/O module	F	Alarm
276	I/O module failure	1. Restart device 2. Change I/O module	F	Alarm

Diagnostic number	Short text	Remedy instructions	Status signal [from the factory]	Diagnostic behavior [from the factory]
282	Data storage	1. Restart device 2. Contact service	F	Alarm
283	Memory content	1. Transfer data or reset device 2. Contact service	F	Alarm
302	Device verification active	Device verification active, please wait.	C	Warning
311	Electronic failure	1. Transfer data or reset device 2. Contact service	F	Alarm
311	Electronic failure	Maintenance required! 1. Do not perform reset 2. Contact service	M	Warning
323	Electronic drift	1. Perform verification manually 2. Change electronic	F	Alarm
Diagnostic of configuration				
410	Data transfer	1. Check connection 2. Retry data transfer	F	Alarm
412	Processing Download	Download active, please wait	C	Warning
431	Trim 1 to 2	Carry out trim	C	Warning
437	Configuration incompatible	1. Restart device 2. Contact service	F	Alarm
438	Dataset	1. Check data set file 2. Check device configuration 3. Up- and download new configuration	M	Warning
441	Current output 1 to 2	1. Check process 2. Check current output settings	S	Warning ¹⁾
442	Frequency output	1. Check process 2. Check frequency output settings	S	Warning ¹⁾
443	Pulse output	1. Check process 2. Check pulse output settings	S	Warning ¹⁾
453	Flow override	Deactivate flow override	C	Warning
484	Simulation failure mode	Deactivate simulation	C	Alarm
485	Simulation measured variable	Deactivate simulation	C	Warning
491	Simulation current output 1 to 2	Deactivate simulation	C	Warning
492	Simulation frequency output	Deactivate simulation frequency output	C	Warning
493	Simulation pulse output	Deactivate simulation pulse output	C	Warning
494	Switch output simulation	Deactivate simulation switch output	C	Warning
495	Diagnostic event simulation	Deactivate simulation	C	Warning
531	Empty pipe detection	Execute EPD adjustment	S	Warning ¹⁾
Diagnostic of process				
801	Supply voltage too low	Increase supply voltage	S	Warning ¹⁾
803	Current loop	1. Check wiring 2. Change I/O module	F	Alarm



Diagnostic number	Short text	Remedy instructions	Status signal [from the factory]	Diagnostic behavior [from the factory]
832	Electronic temperature too high	Reduce ambient temperature	S	Warning ¹⁾
833	Electronic temperature too low	Increase ambient temperature	S	Warning ¹⁾
842	Process limit	Low flow cut off active! 1. Check low flow cut off configuration	S	Warning
861	Process fluid	Check process conditions	F	Alarm ¹⁾
862	Empty pipe	1. Check for gas in process 2. Adjust empty pipe detection	S	Warning ¹⁾
937	EMC interference	Change main electronic module	S	Warning ¹⁾



1) Diagnostic status is changeable.

-  ▪ Diagnostics information 441: Only available for current output 1.
-  ▪ Diagnostics information 491: Only available for current output 1.

12.6 Pending diagnostic events

The **Diagnostics** menu allows the user to view the current diagnostic event and the previous diagnostic event separately.

-  To call up the measures to rectify a diagnostic event:
 - Via local display →  101
 - Via "FieldCare" operating tool →  102

-  Other pending diagnostic events can be displayed in the **Diagnostic list** submenu →  107

Navigation

"Diagnostics" menu

Structure of the submenu

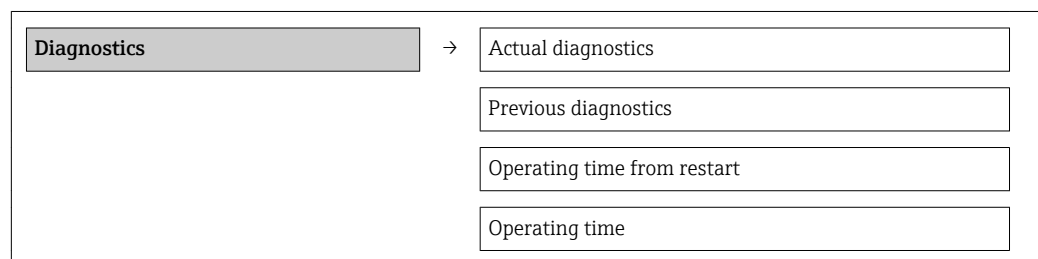

Parameter overview with brief description

Parameter	Prerequisite	Description	User interface	Factory setting
Actual diagnostics	1 diagnostic event has occurred.	Displays the current diagnostic event along with the diagnostic information.  If two or more messages occur simultaneously, the message with the highest priority is shown on the display.	Symbol for diagnostic behavior, diagnostic code and short message.	-
Previous diagnostics	2 diagnostic events have already occurred.	Displays the diagnostic event that occurred prior to the current diagnostic event along with the diagnostic information.	Symbol for diagnostic behavior, diagnostic code and short message.	-
Operating time from restart	-	Shows the time the device has been in operation since the last device restart.	Days (d), hours (h), minutes (m), seconds (s)	
Operating time	-	Indicates how long the device has been in operation.	Days (d), hours (h), minutes (m), seconds (s)	-

12.7 Diagnostic list

In the **Diagnostic list** submenu, up to 5 currently pending diagnostic events can be displayed along with the related diagnostic information. If more than 5 diagnostic events are pending, the events with the highest priority are shown on the display.

Navigation path

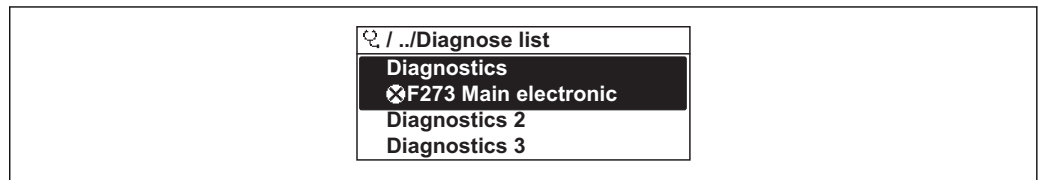

Diagnostics menu → Diagnostic list submenu



 31 Illustrated using the example of the local display



To call up the measures to rectify a diagnostic event:

- Via local display →  101
- Via "FieldCare" operating tool →  102

12.8 Event logbook

12.8.1 Event history

A chronological overview of the event messages that have occurred is provided in the **Events list** submenu.

Navigation path

"Diagnostics" menu → Event logbook → Events list

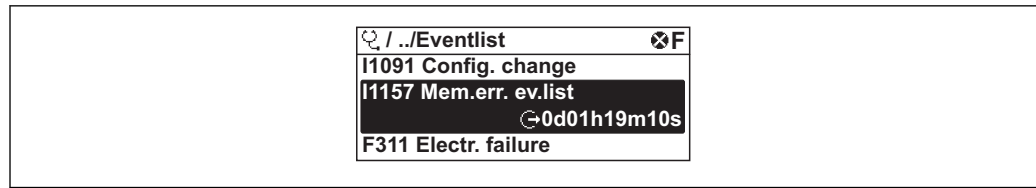

A0014008-EN

32 Illustrated using the example of the local display

A maximum of 20 event messages can be displayed in chronological order. If the advanced HistoROM function is enabled in the device (order option), up to 100 entries can be displayed.

The event history includes entries for:

- Diagnostic events → 104
- Information events → 108

In addition to the operation time of its occurrence, each event is also assigned a symbol that indicates whether the event has occurred or is ended:

- Diagnostic event
 - : Event has occurred
 - : Event has ended
- Information event
 - : Event has occurred

To call up the measures to rectify a diagnostic event:

- Via local display → 101
- Via "FieldCare" operating tool → 102

For filtering the displayed event messages → 108

12.8.2 Filtering the event logbook

Using the **Filter options** parameter, you can define which category of event messages is displayed in the **Events list** submenu.

Navigation path

"Diagnostics" menu → Event logbook → Filter options

Filter categories

- All
- Failure (F)
- Function check (C)
- Out of specification (S)
- Maintenance required (M)
- Information (I)

12.8.3 Overview of information events

Unlike a diagnostic event, an information event is displayed in the event logbook only and not in the diagnostic list.

Info number	Info name
I1000	----- (Device ok)
I1079	Sensor changed
I1089	Power on
I1090	Configuration reset
I1091	Configuration changed
I1092	Trend data deleted

Info number	Info name
I1110	Write protection switch changed
I1137	Electronic changed
I1151	History reset
I1154	Reset terminal voltage min/max
I1155	Reset electronic temperature
I1156	Memory error trend
I1157	Memory error event list
I1185	Display backup done
I1186	Restore via display done
I1187	Settings downloaded with display
I1188	Display data cleared
I1189	Backup compared
I1227	Sensor emergency mode activated
I1228	Sensor emergency mode failed
I1256	Display: access status changed
I1264	Safety sequence aborted
I1335	Firmware changed
I1351	Empty pipe detection adjustment failure
I1353	Empty pipe detection adjustment ok
I1397	Fieldbus: access status changed
I1398	CDI: access status changed
I1440	Main electronic module changed
I1442	I/O module changed
I1444	Device verification passed
I1445	Device verification failed
I1459	Failed: I/O module verification
I1461	Failed: Sensor verification
I1512	Download started
I1513	Download finished
I1514	Upload started
I1515	Upload finished
I1552	Failed: Main electronic verification
I1554	Safety sequence started
I1555	Safety sequence confirmed
I1556	Safety mode off

12.9 Resetting the measuring device

Using the **Device reset** parameter it is possible to reset the entire device configuration or some of the configuration to a defined state.

Navigation

"Setup" menu → Advanced setup → Administration → Device reset

The screenshot shows a hierarchical menu structure. At the top is a grey button labeled 'Administration'. Below it is a grey button labeled 'Define access code'. Underneath that are two white text input fields: 'Define access code' and 'Confirm access code'. At the bottom of the menu is a white text input field labeled 'Device reset'.

Parameter overview with brief description

Parameter	Description	Selection	Factory setting
Device reset	Restart or reset device manually.	<ul style="list-style-type: none"> ■ Cancel ■ To factory defaults ■ To delivery settings ■ Restart device 	Cancel

12.9.1 Function scope of "Device reset" parameter

Options	Description
Cancel	No action is executed and the user exits the parameter.
To delivery settings	Every parameter for which a customer-specific default setting was ordered is reset to this customer-specific value. All other parameters are reset to the factory setting.
Restart device	The restart resets every parameter whose data are in the volatile memory (RAM) to the factory setting (e.g. measured value data). The device configuration remains unchanged.
History reset	Every parameter is reset to its factory setting.

12.10 Device information

The **Device information** submenu contains all the parameters that display different information for identifying the device.





Navigation

"Diagnostics" menu → Device information

The screenshot shows a menu with a grey button labeled 'Device information'. Below it are three white text input fields: 'Device tag', 'Serial number', and 'Firmware version'.

Device name
Order code
Extended order code 1
Extended order code 2
Extended order code 3
ENP version
Device revision
Device ID
Device type
Manufacturer ID

Parameter overview with brief description

Parameter	Description	User interface	Factory setting
Device tag	Enter the name for the measuring point.	Max. 32 characters such as letters, numbers or special characters (e.g. @, %, /)	Promag
Serial number	Shows the serial number of the measuring device.	Max. 11-digit character string comprising letters and numbers.	79AFF16000
Firmware version	Shows the device firmware version installed.	Character string with the following format: xx.yy.zz	01.01.zz
Device name	Shows the name of the transmitter.  The name can be found on the nameplate of the transmitter.	Character string composed of letters, numbers and certain punctuation marks.	Promag
Order code	Shows the device order code.  The order code can be found on the nameplate of the sensor and transmitter in the "Order code" field.	Character string composed of letters, numbers and certain punctuation marks	-
Extended order code 1	Shows the 1st part of the extended order code.  The extended order code can also be found on the nameplate of the sensor and transmitter in the "Ext. ord. cd." field.	Character string	-
Extended order code 2	Shows the 2nd part of the extended order code.  The extended order code can also be found on the nameplate of the sensor and transmitter in the "Ext. ord. cd." field.	Character string	-

Parameter	Description	User interface	Factory setting
Extended order code 3	Shows the 3rd part of the extended order code.  The extended order code can also be found on the nameplate of the sensor and transmitter in the "Ext. ord. cd." field.	Character string	–
ENP version	Shows the version of the electronic nameplate (ENP).	Character string with the following format: xx.yy.zz	2.02.00
Device revision	Shows the device revision with which the device is registered with the HART Communication Foundation.	2-digit hexadecimal number	2
Device ID	Enter device ID of external device.	6-digit hexadecimal number	–
Device type	Displays the device type with which the measuring device is registered with the HART Communication Foundation.	0 to 255	0x48
Manufacturer ID	Displays the manufacturer ID with which the measuring device is registered with the HART Communication Foundation.	0 to 255	0x11

12.11 Firmware history

Release date	Firmware version	Order code for "Firmware version"	Firmware changes	Documentation type	Documentation
04.2015	01.01.zz	Option 75	In accordance with HART 7 Specification	Operating Instructions	BA01111D/06/EN/01.15
07.2012	01.00.zz	Option 78	Original firmware	Operating Instructions	BA01111D/06/EN/01.12

 Flashing the firmware to the current version or to the previous version is possible via the service interface (CDI) .

 For the compatibility of the firmware version with the previous version, the installed device description files and operating tools, observe the information about the device in the "Manufacturer's information" document.

 The manufacturer's information is available:

- In the Download Area of the Endress+Hauser Internet site: www.endress.com → Download
- Specify the following details:
 - Text search: Manufacturer's information
 - Search range: documentation

13 Maintenance

13.1 Maintenance tasks

No special maintenance work is required.

13.1.1 Exterior cleaning

When cleaning the exterior of measuring devices, always use cleaning agents that do not attack the surface of the housing or the seals.

13.1.2 Interior cleaning

No interior cleaning is planned for the device.

13.1.3 Replacing seals

The sensor's seals (particularly aseptic molded seals) must be replaced periodically.

The interval between changes depends on the frequency of the cleaning cycles, the cleaning temperature and the medium temperature.

Replacement seals (accessory) →  137

13.2 Measuring and test equipment

Endress+Hauser offers a wide variety of measuring and test equipment, such as W@M or device tests.

 Your Endress+Hauser Sales Center can provide detailed information on the services.

 For a list of some of the measuring and test equipment, refer to the "Accessories" chapter of the "Technical Information" document for the device.

13.3 Endress+Hauser services

Endress+Hauser offers a wide variety of services for maintenance such as recalibration, maintenance service or device tests.

 Your Endress+Hauser Sales Center can provide detailed information on the services.

14 Repair

14.1 General notes

Repair and conversion concept

The Endress+Hauser repair and conversion concept provides for the following:

- The measuring devices have a modular design.
- Spare parts are grouped into logical kits with the associated Installation Instructions.
- Repairs are carried out by Endress+Hauser Service or by correspondingly trained customers.
- Certified devices can be converted into other certified devices by Endress+Hauser Service or at the factory only.

Notes for repair and conversion

For repair and modification of a measuring device, observe the following notes:

- Use only original Endress+Hauser spare parts.
- Carry out the repair according to the Installation Instructions.
- Observe the applicable standards, federal/national regulations, Ex documentation (XA) and certificates.
- Document every repair and each conversion and enter them into the *W@M* life cycle management database.

14.2 Spare parts

Some interchangeable measuring device components are listed on an overview sign in the connection compartment cover.

The spare part overview sign contains the following information:

- A list of the most important spare parts for the measuring device, including their ordering information.
- The URL for the *W@M Device Viewer* (www.endress.com/deviceviewer):
All the spare parts for the measuring device, along with the order code, are listed here and can be ordered. If available, users can also download the associated Installation Instructions.

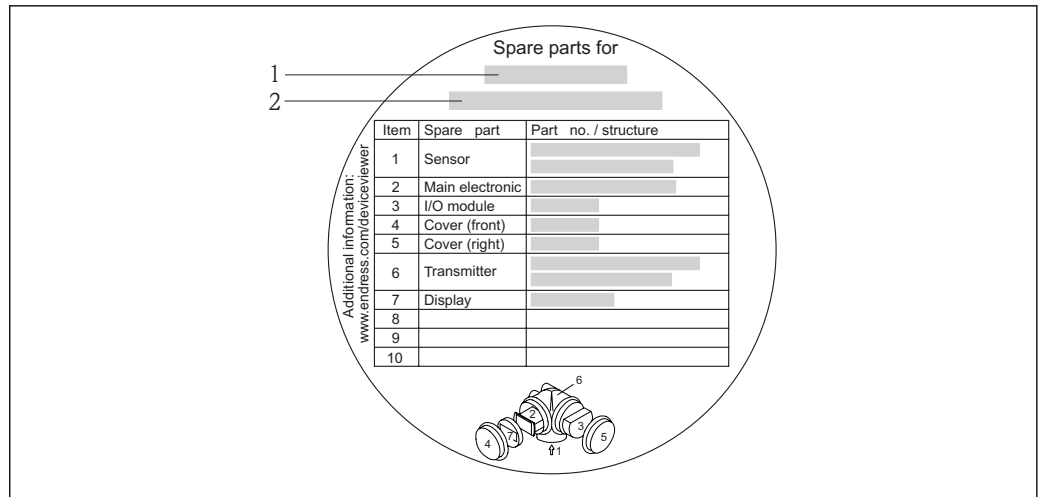

A0014017

33 Example for "Spare part overview sign" in connection compartment cover

- 1 Measuring device name
- 2 Measuring device serial number

- i** Measuring device serial number:
- Is located on the device nameplate and the spare part overview sign.
 - Can be read out via the **Serial number** parameter in the **Device information** submenu → 110.

14.3 Endress+Hauser services

- i** Contact your Endress+Hauser Sales Center for information on services and spare parts.

14.4 Return

The measuring device must be returned if it is need of repair or a factory calibration, or if the wrong measuring device has been delivered or ordered. Legal specifications require Endress+Hauser, as an ISO-certified company, to follow certain procedures when handling products that are in contact with the medium.

To ensure safe, swift and professional device returns, please refer to the procedure and conditions for returning devices provided on the Endress+Hauser website at <http://www.endress.com/support/return-material>

14.5 Disposal

14.5.1 Removing the measuring device

1. Switch off the device.
2. **WARNING!** Danger to persons from process conditions. Beware of hazardous process conditions such as pressure in the measuring device, high temperatures or aggressive fluids.

Carry out the mounting and connection steps from the chapters "Mounting the measuring device" and "Connecting the measuring device" in the logically reverse sequence. Observe the safety instructions.

14.5.2 Disposing of the measuring device

WARNING

Danger to personnel and environment from fluids that are hazardous to health.

- ▶ Ensure that the measuring device and all cavities are free of fluid residues that are hazardous to health or the environment, e.g. substances that have permeated into crevices or diffused through plastic.

Observe the following notes during disposal:



- Observe valid federal/national regulations.
- Ensure proper separation and reuse of the device components.

15 Accessories

Various accessories, which can be ordered with the device or subsequently from Endress+Hauser, are available for the device. Detailed information on the order code in question is available from your local Endress+Hauser sales center or on the product page of the Endress+Hauser website: www.endress.com.

15.1 Device-specific accessories







15.1.1 For the transmitter

Accessories	Description
Remote display FHX50	<p>FHX50 housing to accommodate a display module .</p> <ul style="list-style-type: none"> ▪ FHX50 housing suitable for: <ul style="list-style-type: none"> - SD02 display module (push buttons) - SD03 display module (touch control) ▪ Housing material: <ul style="list-style-type: none"> - Plastic PBT - 316L ▪ Length of connecting cable: up to max. 60 m (196 ft) (cable lengths available for order: 5 m (16 ft), 10 m (32 ft), 20 m (65 ft), 30 m (98 ft)) <p>The measuring device can be ordered with the FHX50 housing and a display module. The following options must be selected in the separate order codes:</p> <ul style="list-style-type: none"> ▪ Order code for measuring device, feature 030: Option L or M "Prepared for FHX50 display" ▪ Order code for FHX50 housing, feature 050 (device version): Option A "Prepared for FHX50 display" ▪ Order code for FHX50 housing, depends on the desired display module in feature 020 (display, operation): <ul style="list-style-type: none"> - Option C: for an SD02 display module (push buttons) - Option E: for an SD03 display module (touch control) <p>The FHX50 housing can also be ordered as a retrofit kit. The measuring device display module is used in the FHX50 housing. The following options must be selected in the order code for the FHX50 housing:</p> <ul style="list-style-type: none"> ▪ Feature 050 (measuring device version): option B "Not prepared for FHX50 display" ▪ Feature 020 (display, operation): option A "None, existing displayed used" <p> For details, see Special Documentation SD01007F</p>
Overvoltage protection for 2-wire devices	<p>Ideally, the overvoltage protection module should be ordered directly with the device. See product structure, characteristic 610 "Accessory mounted", option NA "Overvoltage protection". Separate order necessary only if retrofitting.</p> <ul style="list-style-type: none"> ▪ OVP10: For 1-channel devices (characteristic 020, option A): ▪ OVP20: For 2-channel devices (characteristic 020, options B, C, E or G) <p> For details, see Special Documentation SD01090F.</p>
Weather protection cover	<p>Is used to protect the measuring device from the effects of the weather: e.g. rainwater, excess heating from direct sunlight or extreme cold in winter.</p> <p> For details, see Special Documentation SD00333F</p>
Ground cable	Set, consisting of two ground cables for potential equalization.

15.1.2 For the sensor

Accessories	Description
Ground disks	<p>Are used to ground the fluid in lined measuring tubes to ensure proper measurement.</p> <p> For details, see Installation Instructions EA00070D</p>

15.2 Communication-specific accessories



Accessories	Description
Commubox FXA195 HART	<p>For intrinsically safe HART communication with FieldCare via the USB interface.</p> <p> For details, see "Technical Information" TI00404F</p>
HART Loop Converter HMX50	<p>Is used to evaluate and convert dynamic HART process variables to analog current signals or limit values.</p> <p> For details, see "Technical Information" TI00429F and Operating Instructions BA00371F</p>
Wireless HART adapter SWA70	<p>Is used for the wireless connection of field devices.</p> <p>The WirelessHART adapter can be easily integrated into field devices and existing infrastructures, offers data protection and transmission safety and can be operated in parallel with other wireless networks with minimum cabling complexity.</p> <p> For details, see Operating Instructions BA00061S</p>
Fieldgate FXA320	<p>Gateway for the remote monitoring of connected 4-20 mA measuring devices via a Web browser.</p> <p> For details, see "Technical Information" TI00025S and Operating Instructions BA00053S</p>
Fieldgate FXA520	<p>Gateway for the remote diagnostics and remote configuration of connected HART measuring devices via a Web browser.</p> <p> For details, see "Technical Information" TI00025S and Operating Instructions BA00051S</p>
Field Xpert SFX350	<p>Field Xpert SFX350 is a mobile computer for commissioning and maintenance. It enables efficient device configuration and diagnostics for HART and FOUNDATION Fieldbus devices in the non-Ex area.</p> <p> For details, see Operating Instructions BA01202S</p>
Field Xpert SFX370	<p>Field Xpert SFX370 is a mobile computer for commissioning and maintenance. It enables efficient device configuration and diagnostics for HART and FOUNDATION Fieldbus devices in the non-Ex area and the Ex area.</p> <p> For details, see Operating Instructions BA01202S</p>

15.3 Service-specific accessories

Accessories	Description
Applicator	<p>Software for selecting and sizing Endress+Hauser measuring devices:</p> <ul style="list-style-type: none"> ■ Calculation of all the necessary data for identifying the optimum flowmeter: e.g. nominal diameter, pressure loss, accuracy or process connections. ■ Graphic illustration of the calculation results <p>Administration, documentation and access to all project-related data and parameters throughout the entire life cycle of a project.</p> <p>Applicator is available:</p> <ul style="list-style-type: none"> ■ Via the Internet: https://wapps.endress.com/applicator ■ On CD-ROM for local PC installation.

W@M	<p>Life cycle management for your plant</p> <p>W@M supports you with a wide range of software applications over the entire process: from planning and procurement, to the installation, commissioning and operation of the measuring devices. All the relevant device information, such as the device status, spare parts and device-specific documentation, is available for every device over the entire life cycle.</p> <p>The application already contains the data of your Endress+Hauser device. Endress+Hauser also takes care of maintaining and updating the data records.</p> <p>W@M is available:</p> <ul style="list-style-type: none"> ▪ Via the Internet: www.endress.com/lifecyclemanagement ▪ On CD-ROM for local PC installation.
FieldCare	<p>FDT-based plant asset management tool from Endress+Hauser.</p> <p>It can configure all smart field units in your system and helps you manage them. By using the status information, it is also a simple but effective way of checking their status and condition.</p> <p> For details, see Operating Instructions BA00027S and BA00059S</p>

15.4 System components

Accessories	Description
Memograph M graphic display recorder	<p>The Memograph M graphic display recorder provides information on all relevant measured variables. Measured values are recorded correctly, limit values are monitored and measuring points analyzed. The data are stored in the 256 MB internal memory and also on a SD card or USB stick.</p> <p> For details, see "Technical Information" TI00133R and Operating Instructions BA00247R</p>
RN221N	<p>Active barrier with power supply for safe separation of 4-20 mA standard signal circuits. Offers bidirectional HART transmission.</p> <p> For details, see "Technical Information" TI00073R and Operating Instructions BA00202R</p>
RNS221	<p>Supply unit for powering two 2-wire measuring devices solely in the non-Ex area. Bidirectional communication is possible via the HART communication jacks.</p> <p> For details, see "Technical Information" TI00081R and Brief Operating Instructions KA00110R</p>

16 Technical data

16.1 Application

The measuring device is only suitable for flow measurement of liquids with a minimum conductivity of 20 $\mu\text{S}/\text{cm}$.

Depending on the version ordered, the measuring device can also measure potentially explosive, flammable, poisonous and oxidizing media.

To ensure that the device remains in proper operating condition for its service life, use the measuring device only for media against which the process-wetted materials are adequately resistant.

16.2 Function and system design

Measuring principle	Electromagnetic flow measurement on the basis of <i>Faraday's law of magnetic induction</i> .
Measuring system	The device consists of a transmitter and a sensor. One device version is available: compact version, transmitter and sensor form a mechanical unit. For information on the structure of the device

16.3 Input

Measured variable	Direct measured variables Volume flow (proportional to induced voltage) Calculated measured variables Mass flow
Measuring range	Typically $v = 0.01$ to 10 m/s (0.03 to 33 ft/s) with the specified accuracy

Flow characteristic values in SI units

Nominal diameter		Recommended flow Min./max. full scale value ($v \sim 0.3/10$ m/s) [dm ³ /min]	Factory settings		
[mm]	[in]		Full scale value current output ($v \sim 2.5$ m/s) [dm ³ /min]	Pulse value (~ 2 pulse/s) [dm ³]	Low flow cut off ($v \sim 0.04$ m/s) [dm ³ /min]
15	½	4 to 100	25	0,2	0,5
25	1	9 to 300	75	0,5	1
32	–	15 to 500	125	1	2
40	1 ½	25 to 700	200	1,5	3
50	2	35 to 1 100	300	2,5	5
65	–	60 to 2 000	500	5	8
80	3	90 to 3 000	750	5	12

Nominal diameter		Recommended flow Min./max. full scale value (v ~ 0.3/10 m/s)	Factory settings		
[mm]	[in]		Full scale value current output (v ~ 2.5 m/s)	Pulse value (~ 2 pulse/s)	Low flow cut off (v ~ 0.04 m/s)
		[dm ³ /min]	[dm ³ /min]	[dm ³]	[dm ³ /min]
100	4	145 to 4 700	1200	10	20
125	-	220 to 7 500	1850	15	30
150	6	20 to 600 m ³ /h	150 m ³ /h	0.03 m ³	2.5 m ³ /h
200	8	35 to 1 100 m ³ /h	300 m ³ /h	0.05 m ³	5 m ³ /h

Flow characteristic values in US units

Nominal diameter		Recommended flow Min./max. full scale value (v ~ 0.3/10 m/s)	Factory settings		
[in]	[mm]		Full scale value current output (v ~ 2.5 m/s)	Pulse value (~ 2 pulse/s)	Low flow cut off (v ~ 0.04 m/s)
		[gal/min]	[gal/min]	[gal]	[gal/min]
½	15	1.0 to 27	6	0,1	0,15
1	25	2.5 to 80	18	0,2	0,25
1 ½	40	7 to 190	50	0,5	0,75
2	50	10 to 300	75	0,5	1,25
3	80	24 to 800	200	2	2,5
4	100	40 to 1250	300	2	4
6	150	90 to 2 650	600	5	12
8	200	155 to 4 850	1200	10	15

Recommended measuring range

"Flow limit" section →  129

Operable flow range

Over 1000 : 1

16.4 Output

Output signal

Current output

Current output	4-20 mA HART (passive)
Resolution	< 1 µA
Damping	Adjustable: 0.0 to 999.9 s
Assignable measured variables	<ul style="list-style-type: none"> ▪ Volume flow ▪ Mass flow

Pulse/frequency/switch output

Function	Can be set to pulse, frequency or switch output
Version	Passive, open collector

Maximum input values	<ul style="list-style-type: none"> ▪ DC 35 V ▪ 50 mA
Voltage drop	<ul style="list-style-type: none"> ▪ For ≤ 2 mA: 2 V ▪ For 10 mA: 8 V
Residual current	≤ 0.05 mA
Pulse output	
Pulse width	Adjustable: 5 to 2 000 ms
Maximum pulse rate	100 Impulse/s
Pulse value	Adjustable
Assignable measured variables	<ul style="list-style-type: none"> ▪ Volume flow ▪ Mass flow
Frequency output	
Output frequency	Adjustable: 0 to 1 000 Hz
Damping	Adjustable: 0 to 999 s
Pulse/pause ratio	1:1
Assignable measured variables	<ul style="list-style-type: none"> ▪ Volume flow ▪ Mass flow
Switch output	
Switching behavior	Binary, conductive or non-conductive
Switching delay	Adjustable: 0 to 100 s
Number of switching cycles	Unlimited
Assignable functions	<ul style="list-style-type: none"> ▪ Off ▪ On ▪ Diagnostic behavior ▪ Limit value <ul style="list-style-type: none"> - Volume flow - Mass flow ▪ Flow direction monitoring ▪ Status <ul style="list-style-type: none"> - Empty pipe detection - Low flow cut off

Signal on alarm

Depending on the interface, failure information is displayed as follows:

Current output

4-20 mA

Failure mode	Selectable (as per NAMUR recommendation NE 43): <ul style="list-style-type: none"> ▪ Minimum value: 3.6 mA ▪ Maximum value: 22 mA ▪ Defined value: 3.59 to 22.5 mA ▪ Actual value ▪ Last valid value
---------------------	---

HART

Device diagnostics	Device condition can be read out via HART Command 48
---------------------------	--

Pulse/frequency/switch output

Pulse output

Failure mode	Choose from: <ul style="list-style-type: none"> ■ Actual value ■ No pulses
---------------------	--

Frequency output

Failure mode	Choose from: <ul style="list-style-type: none"> ■ Actual value ■ 0 Hz ■ Defined value: 0 to 1 250 Hz
---------------------	---

Switch output

Failure mode	Choose from: <ul style="list-style-type: none"> ■ Current status ■ Open ■ Closed
---------------------	---

Local display

Plain text display	With information on cause and remedial measures
Backlight	Additionally for device version with SD03 local display: red lighting indicates a device error.

 Status signal as per NAMUR recommendation NE 107

Operating tool

- Via digital communication:
 - HART protocol
- Via service interface

Plain text display	With information on cause and remedial measures
---------------------------	---



Load →  30

Low flow cut off The switch points for low flow cut off are user-selectable.

Galvanic isolation All outputs are galvanically isolated from one another.

Protocol-specific data

HART

- For information on the device description files →  57
- For information on the dynamic variables and measured variables (HART device variables) →  57

16.5 Power supply

Terminal assignment →  30

Supply voltage

Transmitter

An external power supply is required for each output. The following supply voltage values apply for the 4-20 mA HART current output:

Order code for "Output"	Minimum terminal voltage	Maximum terminal voltage
Option A ^{1) 2)} : 4-20 mA HART	For 4 mA: ≥ DC 18 V For 20 mA: ≥ DC 14 V	DC 35 V
Option B ^{1) 2)} : 4-20 mA HART, pulse/frequency/switch output	For 4 mA: ≥ DC 18 V For 20 mA: ≥ DC 14 V	DC 35 V

- 1) External supply voltage of the power supply unit with load.
- 2) For device versions with SD03 local display: The terminal voltage must be increased by DC 2 V if backlighting is used.

Power consumption

Transmitter

Order code for "Output"	Maximum power consumption
Option A: 4-20 mA HART	770 mW
Option B: 4-20 mA HART, pulse/frequency/switch output	<ul style="list-style-type: none"> ■ Operation with output 1: 770 mW ■ Operation with output 1 and 2: 2.770 mW

Current consumption

Current output

For every 4-20 mA or 4-20 mA HART current output: 3.6 to 22.5 mA

 If the option **Defined value** is selected in the **Failure mode** parameter : 3.59 to 22.5 mA

Power supply failure

- Totalizers stop at the last value measured.
- Configuration is retained in the device memory (HistoROM).
- Error messages (incl. total operated hours) are stored.

Electrical connection →  31

Potential equalization →  33

Terminals

- For device version without integrated overvoltage protection: plug-in spring terminals for wire cross-sections 0.5 to 2.5 mm² (20 to 14 AWG)
- For device version with integrated overvoltage protection: screw terminals for wire cross-sections 0.2 to 2.5 mm² (24 to 14 AWG)

Cable entries

- Cable gland: M20 × 1.5 with cable ϕ 6 to 12 mm (0.24 to 0.47 in)
- Thread for cable entry:
 - NPT 1/2"
 - G 1/2"

Cable specification →  29

Overvoltage protection The device can be ordered with integrated overvoltage protection for diverse approvals:
Order code for "Accessory mounted", option NA "Overvoltage protection"

Input voltage range	Values correspond to supply voltage specifications ¹⁾
Resistance per channel	2 · 0.5 Ω max
DC sparkover voltage	400 to 700 V
Trip surge voltage	< 800 V
Capacitance at 1 MHz	< 1.5 pF
Nominal discharge current (8/20 μs)	10 kA
Temperature range	-40 to +85 °C (-40 to +185 °F)

1) The voltage is reduced by the amount of the internal resistance $I_{\min} \cdot R_i$

 Depending on the temperature class, restrictions apply to the ambient temperature for device versions with overvoltage protection .

 For detailed information on the temperature tables, see the separate document entitled "Safety Instructions" (XA) for the device.

16.6 Performance characteristics

Reference operating conditions

In accordance with DIN EN 29104

- Water, typically 15 to 45 °C (59 to 113 °F); 2 to 6 bar (29 to 87 psi)
- Data as indicated in the calibration protocol ± 5 °C (± 41 °F) and ± 2 bar (± 29 psi)
- Accuracy based on accredited calibration rigs traced to ISO 17025
- Medium temperature: $+28 \pm 2$ °C ($+82 \pm 4$ °F)
- Ambient temperature: $+22 \pm 2$ °C ($+72 \pm 4$ °F)
- Warm-up period: 30 min

Installation

- Inlet run $> 10 \times DN$
- Outlet run $> 5 \times DN$
- Sensor and transmitter grounded.
- The sensor is centered in the pipe.

Maximum measured error

Error limits under reference operating conditions

o.r. = of reading

Volume flow

± 0.5 % o.r. ± 2 mm/s (0.08 in/s)

 Fluctuations in the supply voltage do not have any effect within the specified range.

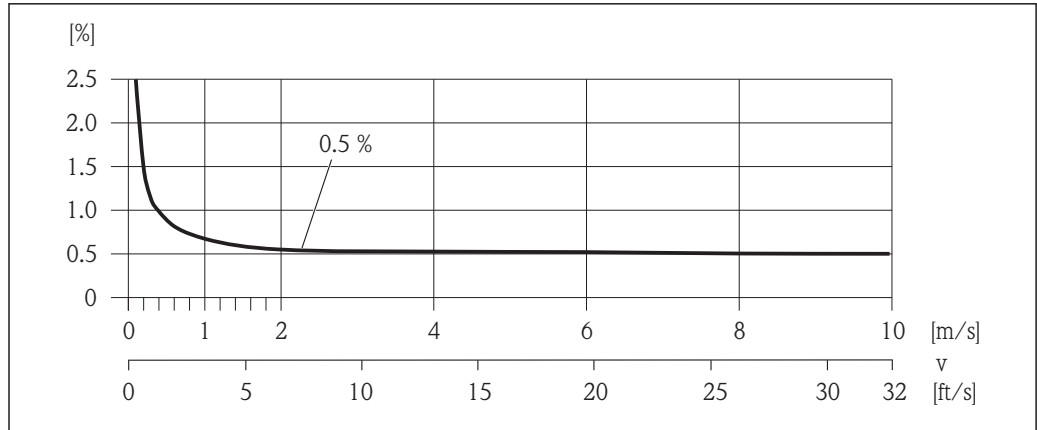

34 Maximum measured error in % o.r.

Accuracy of outputs

o.r. = of reading

Current output

Accuracy	±10 µA
----------	--------

Pulse/frequency output

Accuracy	Max. ±100 ppm o.r.
----------	--------------------

Repeatability

o.r. = of reading

Volume flow

Max. ±0.2 % o.r. ± 2 mm/s (0.08 in/s)

Influence of ambient temperature

o.r. = of reading

Current output

Additional error, in relation to the span of 16 mA:

Temperature coefficient at zero point (4 mA)	0.02 %/10 K
Temperature coefficient with span (20 mA)	0.05 %/10 K

Pulse/frequency output

Temperature coefficient	Max. ±100 ppm o.r.
-------------------------	--------------------

16.7 Installation

"Mounting requirements" → 19

16.8 Environment

Ambient temperature range →  21

Temperature tables

 Observe the interdependencies between the permitted ambient and fluid temperatures when operating the device in hazardous areas.

 For detailed information on the temperature tables, see the separate document entitled "Safety Instructions" (XA) for the device.

Storage temperature The storage temperature corresponds to the operating temperature range of the measuring transmitter and the appropriate measuring sensors.

- Protect the measuring device against direct sunlight during storage in order to avoid unacceptably high surface temperatures.
- Select a storage location where moisture cannot collect in the measuring device as fungus or bacteria infestation can damage the liner.
- If protection caps or protective covers are mounted these should never be removed before installing the measuring device.

Degree of protection **Transmitter**

- As standard: IP66/67, type 4X enclosure
- When housing is open: IP20, type 1 enclosure
- Display module: IP20, type 1 enclosure

Sensor
IP66/67, type 4X enclosure

Shock resistance As per IEC/EN 60068-2-31

Vibration resistance Acceleration up to 2 g, according to IEC 60068-2-6

Mechanical load

- Protect the transmitter housing against mechanical effects, such as shock or impact.
- Never use the transmitter housing as a ladder or climbing aid.

Electromagnetic compatibility (EMC) As per IEC/EN 61326 and NAMUR Recommendation 21 (NE 21)

 For details refer to the Declaration of Conformity.

16.9 Process

Medium temperature range

- -20 to +150 °C (-4 to +302 °F) for PFA
- -40 to +130 °C (-40 to +266 °F) for PTFE

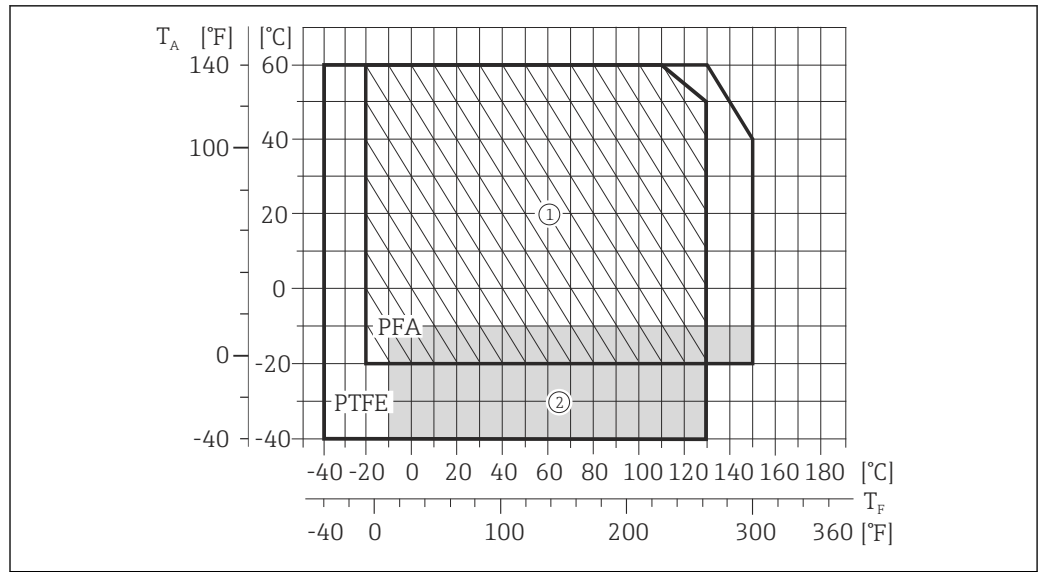

A0017724

T_A Ambient temperature

T_F Medium temperature

1 Hatched area: harsh environment only up to +130 °C (+266 °F)

2 Gray area: the ambient and fluid temperature range of -10 to -40 °C (-14 to -40 °F) applies to stainless flanges only

Conductivity ≥ 20 µS/cm for liquids in general

Pressure-temperature ratings



An overview of the pressure-temperature ratings for the process connections is provided in the "Technical Information" document

Pressure tightness "-" = no specifications possible

Liner: PFA

Nominal diameter		Limit values for absolute pressure in [mbar] ([psi]) for fluid temperatures:		
[mm]	[in]	+25 °C (+77 °F)	+80 °C (+176 °F)	+100 to +180 °C (+212 to +356 °F)
25	1	0 (0)	0 (0)	0 (0)
32	-	0 (0)	0 (0)	0 (0)
40	1 ½	0 (0)	0 (0)	0 (0)
50	2	0 (0)	0 (0)	0 (0)
65	-	0 (0)	-	0 (0)
80	3	0 (0)	-	0 (0)
100	4	0 (0)	-	0 (0)
125	-	0 (0)	-	0 (0)
150	6	0 (0)	-	0 (0)
200	8	0 (0)	-	0 (0)

Liner: PTFE



Nominal diameter		Limit values for absolute pressure in [mbar] ([psi]) for fluid temperatures:			
[mm]	[in]	+25 °C (+77 °F)	+80 °C (+176 °F)	+100 °C (+212 °F)	+130 °C (+266 °F)
15	½	0 (0)	0 (0)	0 (0)	100 (1.45)
25	1	0 (0)	0 (0)	0 (0)	100 (1.45)
32	–	0 (0)	0 (0)	0 (0)	100 (1.45)
40	1 ½	0 (0)	0 (0)	0 (0)	100 (1.45)
50	2	0 (0)	0 (0)	0 (0)	100 (1.45)
65	–	0 (0)	–	40 (0.58)	130 (1.89)
80	3	0 (0)	–	40 (0.58)	130 (1.89)
100	4	0 (0)	–	135 (1.96)	170 (2.47)
125	–	135 (1.96)	–	240 (3.48)	385 (5.58)
150	6	135 (1.96)	–	240 (3.48)	385 (5.58)
200	8	200 (2.90)	–	290 (4.21)	410 (5.95)

Flow limit

The diameter of the pipe and the flow rate determine the nominal diameter of the sensor. The optimum velocity of flow is between 2 to 3 m/s (6.56 to 9.84 ft/s). Also match the velocity of flow (v) to the physical properties of the fluid:

- v < 2 m/s (6.56 ft/s): for abrasive fluids (e.g. potter's clay, lime milk, ore slurry)
- v > 2 m/s (6.56 ft/s): for fluids producing buildup (e.g. wastewater sludges)

 A necessary increase in the flow velocity can be achieved by reducing the sensor nominal diameter.

 For an overview of the measuring range full scale values, see the "Measuring range" section →  120

Pressure loss

- No pressure loss occurs if the sensor is installed in a pipe with the same nominal diameter.
- Pressure losses for configurations incorporating adapters according to DIN EN 545 →  22

System pressure

→  21

Vibrations

→  22

16.10 Mechanical construction

Design, dimensions

 For the dimensions and installation lengths of the device, see the "Technical Information" document, "Mechanical construction" section

Weight

Compact version

- Including the transmitter (1.9 kg (4.2 lbs))
- Weight specifications apply to standard pressure ratings and without packaging material.

Weight in SI units

Nominal diameter		EN (DIN), AS ¹⁾		ASME		JIS	
[mm]	[in]	Pressure rating	[kg]	Pressure rating	[kg]	Pressure rating	[kg]
15	½	PN 40	5.0	Class 150	5.0	10K	5.0
25	1	PN 40	5.8	Class 150	5.8	10K	5.8
32	1 ¼	PN 40	6.5	Class 150	-	10K	5.8
40	1 ½	PN 40	7.9	Class 150	7.9	10K	6.8
50	2	PN 40	9.1	Class 150	9.1	10K	7.8
65	2 ½	PN 16	10.5	Class 150	-	10K	9.6
80	3	PN 16	12.5	Class 150	12.5	10K	11.0
100	4	PN 16	14.5	Class 150	14.5	10K	13.2
125	5	PN 16	20.0	Class 150	-	10K	19.5
150	6	PN 16	24.0	Class 150	24.0	10K	23.0
200	8	PN 10	43.5	Class 150	43.5	10K	40.4

1) For flanges to AS, only DN 25 and 50 are available.

Weight in US units

Nominal diameter		ASME	
[mm]	[in]	Pressure rating	[lbs]
15	½	Class 150	11.0
25	1	Class 150	12.8
32	1 ¼	Class 150	-
40	1 ½	Class 150	17.4
50	2	Class 150	20.1
65	2 ½	Class 150	-
80	3	Class 150	27.6
100	4	Class 150	32.0
125	5	Class 150	-
150	6	Class 150	52.9
200	8	Class 150	95.9

Measuring tube specification

Nominal diameter		Pressure rating					Process connection internal diameter			
		EN (DIN)	ASME	AS 2129	AS 4087	JIS	PFA		PTFE	
[mm]	[in]	[bar]	[psi]	[bar]	[bar]	[bar]	[mm]	[in]	[mm]	[in]
15	½	PN 40	Class 150	-	-	20K	-	-	15	0.59
25	1	PN 40	Class 150	Table E	-	20K	23	0.91	26	1.02
32	-	PN 40	-	-	-	20K	32	1.26	35	1.38
40	1 ½	PN 40	Class 150	-	-	20K	36	1.42	41	1.61
50	2	PN 40	Class 150	Table E	PN 16	10K	48	1.89	52	2.05
65	-	PN 16	-	-	-	10K	63	2.48	67	2.64
80	3	PN 16	Class 150	-	-	10K	75	2.95	80	3.15

Nominal diameter		Pressure rating					Process connection internal diameter			
		EN (DIN)	ASME	AS 2129	AS 4087	JIS	PFA		PTFE	
[mm]	[in]	[bar]	[psi]	[bar]	[bar]	[bar]	[mm]	[in]	[mm]	[in]
100	4	PN 16	Class 150	-	-	10K	101	3.98	104	4.09
125	-	PN 16	-	-	-	10K	126	4.96	129	5.08
150	6	PN 16	Class 150	-	-	10K	154	6.06	156	6.14
200	8	PN 10	Class 150	-	-	10K	201	7.91	202	7.95

Materials

Transmitter housing

- Order code for "Housing", option **C** "Compact, aluminum coated": Aluminum, AlSi10Mg, coated
- Window material: glass

Cable entries/cable glands

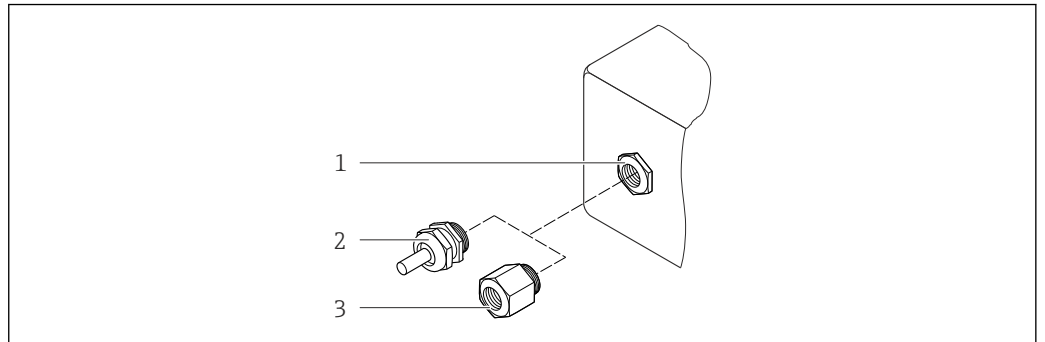

A0020640

35 Possible cable entries/cable glands

- 1 Cable entry in transmitter housing, wall-mount housing or connection housing with internal thread M20 x 1.5
- 2 Cable gland M20 x 1.5
- 3 Adapter for cable entry with internal thread G 1/2" or NPT 1/2"

Order code for "Housing", option **C** "GT20 two-chamber, aluminum coated"

Cable entry/cable gland	Type of protection	Material
Cable gland M20 x 1.5	<ul style="list-style-type: none"> ■ Non-Ex ■ Ex ia ■ Ex ic 	Plastic
	Adapter for cable entry with internal thread G 1/2"	Nickel-plated brass
Adapter for cable entry with internal thread NPT 1/2"	For non-Ex and Ex (except for CSA Ex d/XP)	Nickel-plated brass
Thread NPT 1/2" via adapter	For non-Ex and Ex	

Sensor housing

Coated aluminum AlSi10Mg

Measuring tubes

Stainless steel, 1.4301/304/1.4306/304L; for flanges made of carbon steel with Al/Zn protective coating

Liner

- PFA
- PTFE

Process connections

EN 1092-1 (DIN 2501)

Stainless steel, 1.4571 (F316L); carbon steel, FE410WB/S235JRG2; Alloy C22, 2.4602 (UNS N06022) (with Al/Zn protective varnish)

ASME B16.5

Stainless steel, F316L; carbon steel, A105 (with Al/Zn protective varnish)

JIS B2220

Stainless steel, 1.0425 (F316L); carbon steel, S235JRG2/HII (with Al/Zn protective varnish)

Electrodes

Stainless steel, 1.4435 (F316L); Alloy C22, 2.4602 (UNS N06022); platinum; tantalum; titanium

Seals

In accordance with DIN EN 1514-1

Accessories*Weather protection cover*

Stainless steel 1.4404 (316L)

Ground disks

Stainless steel, 1.4435 (F316L); Alloy C22, 2.4602 (UNS N06022); tantalum; titanium

Fitted electrodes

Measuring electrodes, reference electrodes and electrodes for empty pipe detection:

- Standard: stainless steel, 1.4435 (F316L); Alloy C22, 2.4602 (UNS N06022); tantalum, titanium
- Optional: only platinum measuring electrodes

Process connections

- EN 1092-1 (DIN 2501); dimensions as per DIN 2501, DN 65 PN 16 only as per EN 1092-1
- ASME B16.5
- JIS B2220
- AS 2129 Table E
- AS 4087 PN 16



For information on the materials of the process connections → 132

Surface roughness

Stainless steel electrodes, 1.4435 (F316L); Alloy C22, 2.4602 (UNS N06022); platinum; tantalum; titanium:

≤ 0.3 to 0.5 μm (11.8 to 19.7 μin)

(All data relate to parts in contact with fluid)

Liner with PFA:
 $\leq 0.4 \mu\text{m}$ (15.7 μin)
 (All data relate to parts in contact with fluid)

16.11 Operability

Local operation



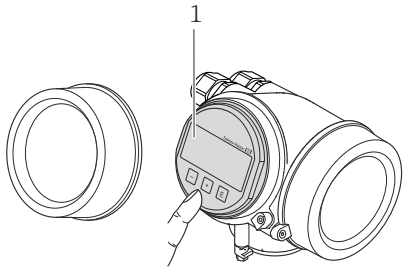
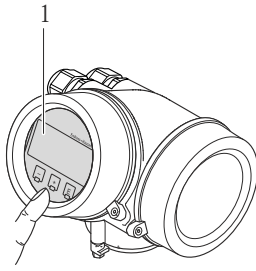



Via display module

Order code for "Display; Operation", option C "SD02"	Order code for "Display; Operation", option E "SD03"
 <p style="text-align: right; font-size: small;">A0015544</p>	 <p style="text-align: right; font-size: small;">A0015546</p>
1 Operation with pushbuttons	1 Operation with touch control

Display elements

- 4-line display
- With order code for "Display; operation", option E:
White background lighting; switches to red in event of device errors
- Format for displaying measured variables and status variables can be individually configured
- Permitted ambient temperature for the display: -20 to $+60 \text{ }^\circ\text{C}$ (-4 to $+140 \text{ }^\circ\text{F}$)
The readability of the display may be impaired at temperatures outside the temperature range.

Operating elements

- With order code for "Display; operation", option C:
Local operation with 3 push buttons: , , 
- With order code for "Display; operation", option E:
External operation via touch control; 3 optical keys: , , 
- Operating elements also accessible in various hazardous areas

Additional functionality

- Data backup function
The device configuration can be saved in the display module.
- Data comparison function
The device configuration saved in the display module can be compared to the current device configuration.
- Data transfer function
The transmitter configuration can be transmitted to another device using the display module.

Via remote display and operating module FHX50

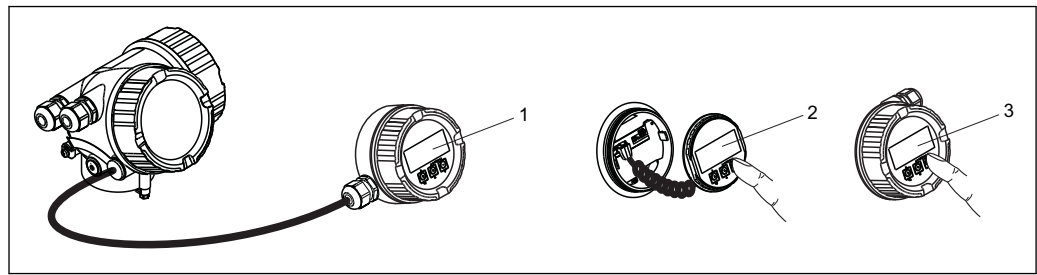

A0013137

36 Operating options via FHX50

- 1 Housing of remote display and operating module FHX50
- 2 SD02 display and operating module, push buttons: cover must be opened for operation
- 3 SD03 display and operating module, optical buttons: operation possible through cover glass

Remote operation

Via HART protocol

This communication interface is available in device versions with a HART output.

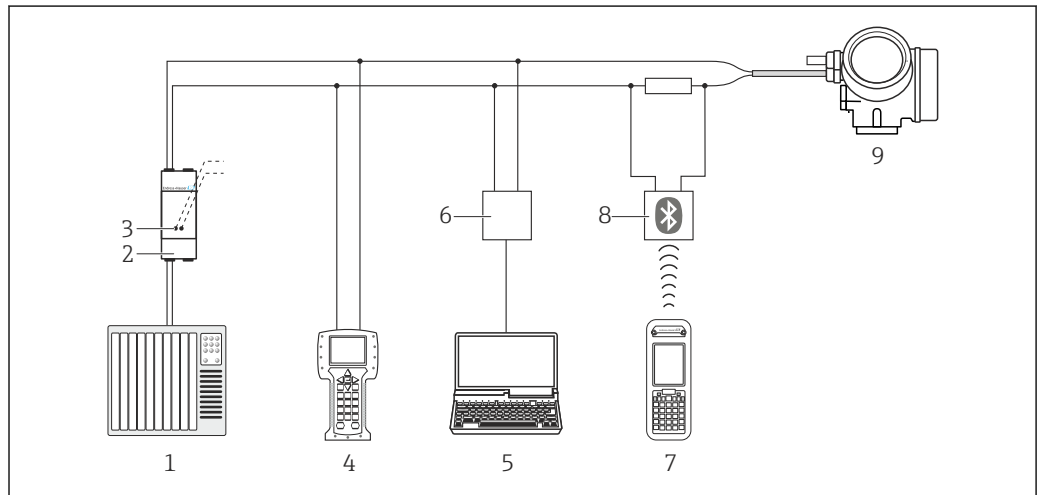

A0013764

37 Options for remote operation via HART protocol

- 1 Control system (e.g. PLC)
- 2 Transmitter power supply unit, e.g. RN221N (with communication resistor)
- 3 Connection for Commubox FXA195 and Field Communicator 475
- 4 Field Communicator 475
- 5 Computer with operating tool (e.g. FieldCare, AMS Device Manager, SIMATIC PDM)
- 6 Commubox FXA195 (USB)
- 7 Field Xpert SFX350 or SFX370
- 8 VIATOR Bluetooth modem with connecting cable
- 9 Transmitter

Service interface

Via service interface (CDI)

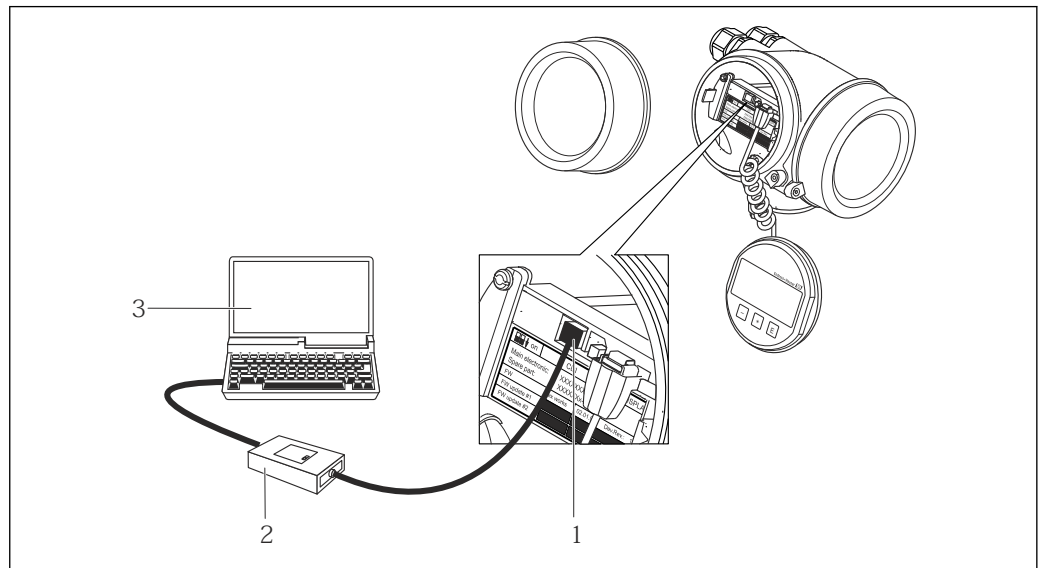

- 1 Service interface (CDI = Endress+Hauser Common Data Interface) of the measuring device
 2 Commubox FXA291
 3 Computer with "FieldCare" operating tool with COM DTM "CDI Communication FXA291"

A0014019

Languages

Can be operated in the following languages:

- Via local display:
English, German, French, Spanish, Italian, Dutch, Portuguese, Polish, Russian, Swedish, Turkish, Chinese, Japanese, Bahasa (Indonesian), Vietnamese, Czech
- Via "FieldCare" operating tool:
English, German, French, Spanish, Italian, Chinese, Japanese

16.12 Certificates and approvals

CE mark

The measuring system is in conformity with the statutory requirements of the applicable EC Directives. These are listed in the corresponding EC Declaration of Conformity along with the standards applied.

Endress+Hauser confirms successful testing of the device by affixing to it the CE mark.

C-Tick symbol

The measuring system meets the EMC requirements of the "Australian Communications and Media Authority (ACMA)".

Ex approval

The devices are certified for use in hazardous areas and the relevant safety instructions are provided in the separate "Safety Instructions" (XA) document. Reference is made to this document on the nameplate.

Functional safety

The measuring device can be used for flow monitoring systems (min., max., range) up to SIL 2 (single-channel architecture) and SIL 3 (multichannel architecture with homogeneous redundancy) and is independently evaluated and certified by the TÜV in accordance with IEC 61508.

The following types of monitoring in safety equipment are possible:
Volume flow



Functional Safety Manual with information on the SIL device → 138

HART certification

HART interface

The measuring device is certified and registered by the HCF (HART Communication Foundation). The measuring system meets all the requirements of the following specifications:

- Certified according to HART 7
- The device can also be operated with certified devices of other manufacturers (interoperability)

Other standards and guidelines

- EN 60529
Degrees of protection provided by enclosures (IP code)
- EN 61010-1
Safety requirements for electrical equipment for measurement, control and laboratory use
- IEC/EN 61326
Emission in accordance with Class A requirements. Electromagnetic compatibility (EMC requirements).
- ANSI/ISA-61010-1 (82.02.01): 2004
Safety Requirements for Electrical Equipment for Measurement, Control and Laboratory Use - Part 1 General Requirements
- CAN/CSA-C22.2 No. 61010-1-04
Safety Requirements for Electrical Equipment for Measurement, Control and Laboratory Use - Part 1 General Requirements
- NAMUR NE 21
Electromagnetic compatibility (EMC) of industrial process and laboratory control equipment
- NAMUR NE 32
Data retention in the event of a power failure in field and control instruments with microprocessors
- NAMUR NE 43
Standardization of the signal level for the breakdown information of digital transmitters with analog output signal.
- NAMUR NE 53
Software of field devices and signal-processing devices with digital electronics
- NAMUR NE 105
Specifications for integrating fieldbus devices in engineering tools for field devices
- NAMUR NE 107
Self-monitoring and diagnosis of field devices
- NAMUR NE 131
Requirements for field devices for standard applications

16.13 Application packages

Many different application packages are available to enhance the functionality of the device. Such packages might be needed to address safety aspects or specific application requirements.

The application packages can be ordered with the device or subsequently from Endress+Hauser. Detailed information on the order code in question is available from your local Endress+Hauser sales center or on the product page of the Endress+Hauser website: www.endress.com.



Diagnostics functions

Package	Description
HistoROM extended function	<p>Comprises extended functions concerning the event log and the activation of the measured value memory.</p> <p>Event log: Memory volume is extended from 20 message entries (basic version) to up to 100 entries.</p> <p>Data logging (line recorder):</p> <ul style="list-style-type: none"> Memory capacity for up to 1000 measured values is activated. 250 measured values can be output via each of the 4 memory channels. The recording interval can be defined and configured by the user. Data logging is visualized via the local display or FieldCare.

Heartbeat Technology

Package	Description
Heartbeat Verification	<p>Heartbeat Verification: Makes it possible to check the device functionality on demand when the device is installed, without having to interrupt the process.</p> <ul style="list-style-type: none"> Access via onsite operation or other operating interfaces, such as FieldCare for instance. Documentation of device functionality within the framework of manufacturer specifications, for proof testing for instance. End-to-end, traceable documentation of the verification results, including report. Makes it possible to extend calibration intervals in accordance with operator's risk assessment.

16.14 Accessories

 Overview of accessories available for order →  117

16.15 Documentation

-  For an overview of the scope of the associated Technical Documentation, refer to the following:
- The CD-ROM provided for the device (depending on the device version, the CD-ROM might not be part of the delivery!)
 - The *W@M Device Viewer* : Enter the serial number from the nameplate (www.endress.com/deviceviewer)
 - The *Endress+Hauser Operations App*: Enter the serial number from the nameplate or scan the 2-D matrix code (QR code) on the nameplate.

Standard documentation

Brief Operating Instructions

Measuring device	Documentation code
Promag P 200	KA01121D

Device Parameters

Measuring device	Documentation code		
	HART	FOUNDATION Fieldbus	PROFIBUS PA
Promag 200	GP01026D	GP01028D	GP01027D

Technical Information

Measuring device	Documentation code
Promag P 200	TI01062D

Supplementary device-dependent documentation



Safety Instructions

Contents	Documentation code
ATEX/IECEX Ex d[ia], Ex tb	XA01015D
ATEX/IECEX Ex ia, Ex tb	XA01016D
ATEX/IECEX Ex nA, Ex ic	XA01017D
cCSAus XP (Ex d)	XA01018D
cCSAus IS (Ex i)	XA01019D
NEPSI Ex d	XA01179D
NEPSI Ex i	XA01178D
NEPSI Ex nA, Ex ic	XA01180D
INMETRO Ex d	XA01309D
INMETRO Ex i	XA01310D
INMETRO Ex nA	XA01311D

Special Documentation

Contents	Documentation code
Information on the Pressure Equipment Directive	SD01056D
Functional Safety Manual	SD01451D
Heartbeat Technology	SD01452D

Installation Instructions

Contents	Documentation code
Installation Instructions for spare part sets	 Overview of accessories available for order →  117

Index

A

- Access authorization to parameters
 - Read access 51
 - Write access 51
- Access code 51
 - Incorrect input 51
- Adapters 22
- Adapting the diagnostic behavior 103
- Adapting the status signal 103
- Ambient temperature
 - Influence 126
- Ambient temperature range 21
- AMS Device Manager 55
 - Function 55
- Application 9, 120
- Applicator 120
- Approvals 135

B

- Burst mode 58

C

- C-Tick symbol 135
- Cable entries
 - Technical data 124
- Cable entry
 - Degree of protection 36
- CE mark 10, 135
- Certificates 135
- Checklist
 - Post-connection check 37
 - Post-installation check 28
- Cleaning
 - Exterior cleaning 113
 - Interior cleaning 113
- Commissioning 61
 - Advanced settings 79
 - Configuring the measuring device 61
- Communication-specific data 57
- Conductivity 128
- Connecting cable 29
- Connecting the measuring device 31
- Connection
 - see Electrical connection
- Connection examples, potential equalization 33
- Connection preparations 31
- Connection tools 29
- Context menu
 - Closing 46
 - Explanation 46
 - Opening 46
- Current consumption 124

D

- Declaration of Conformity 10
- Define access code 88

- Degree of protection 36, 127
- Design
 - Measuring device 12
- Designated use 9
- Device components 12
- Device description files 57
- Device documentation
 - Supplementary documentation 8
- Device locking, status 91
- Device name
 - Sensor 15
 - Transmitter 14
- Device repair 114
- Device revision 57
- Device type ID 57
- Diagnostic behavior
 - Explanation 100
 - Symbols 100
- Diagnostic information
 - Design, description 100, 102
 - FieldCare 101
 - Local display 99
 - Overview 104
 - Remedial measures 104
- Diagnostic list 107
- Diagnostic message 99
- Diagnostics
 - Symbols 99
- DIP switch
 - see Write protection switch
- Direct access 48
- Direct access code 43
- Disabling write protection 88
- Display
 - Current diagnostic event 106
 - Previous diagnostic event 106
 - see Local display
- Display area
 - For operational display 41
 - In the navigation view 43
- Display values
 - For locking status 91
- Disposal 115
- Document
 - Function 6
 - Symbols used 6
- Document function 6
- Documentation 137
- Down pipe 19

E

- Electrical connection
 - Commubox FXA195 53
 - Commubox FXA195 (USB) 134
 - Commubox FXA291 53, 135
 - Degree of protection 88

- Field Communicator 53
 - Field Communicator 475 134
 - Field Xpert SFX350/SFX370 134
 - Handheld terminals 53
 - Measuring device 29
 - Operating tool (e.g. FieldCare, AMS Device Manager, SIMATIC PDM) 134
 - Operating tools 53
 - Via HART protocol 53, 134
 - Via service interface (CDI) 53, 135
 - Transmitter power supply unit 134
 - VIATOR Bluetooth modem 134
 - Electromagnetic compatibility 127
 - Enabling write protection 88
 - Endress+Hauser services
 - Maintenance 113
 - Repair 115
 - Environment
 - Ambient temperature 21
 - Mechanical load 127
 - Shock resistance 127
 - Storage temperature 127
 - Vibration resistance 127
 - Error messages
 - see Diagnostic messages
 - Event history 107
 - Events list 107
 - Ex approval 135
 - Extended order code
 - Sensor 15
 - Transmitter 14
 - Exterior cleaning 113
- F**
- Field Communicator
 - Function 56
 - Field Communicator 475 56
 - Field of application
 - Residual risks 10
 - Field Xpert
 - Function 54
 - Field Xpert SFX350 54
 - FieldCare 54
 - Device description file 57
 - Function 54
 - User interface 55
 - Filtering the event logbook 108
 - Firmware
 - Release date 57
 - Version 57
 - Firmware history 112
 - Fitted electrodes 132
 - Flow direction 20
 - Flow limit 129
 - Function check 61
 - Function scope
 - AMS Device Manager 55
 - Field Communicator 56
 - Field Communicator 475 56
 - Field Xpert 54
 - SIMATIC PDM 55
 - Functional safety (SIL) 135
 - Functions
 - see Parameters
- G**
- Galvanic isolation 123
- H**
- Hardware write protection 89
 - HART certification 136
 - HART protocol
 - Device variables 57
 - Measured variables 57
 - Help text
 - Calling up 49
 - Close 49
 - Explanation 49
 - HistoROM 85
- I**
- I/O electronics module 12, 31
 - Identifying the measuring device 13
 - Incoming acceptance 13
 - Influence
 - Ambient temperature 126
 - Information on the document 6
 - Inlet runs 20
 - Input 120
 - Input mask 44
 - Inspection
 - Installation 28
 - Received goods 13
 - Inspection check
 - Connection 37
 - Installation 19
 - Installation conditions
 - Adapters 22
 - Down pipe 19
 - Inlet and outlet runs 20
 - Mounting location 19
 - Orientation 20
 - Partially filled pipe 19
 - System pressure 21
 - Vibrations 22
 - Installation dimensions 21
 - Interior cleaning 113
- K**
- Keypad lock
 - Disabling 51
 - Enabling 51
- L**
- Languages, operation options 135
 - Line recorder 94
 - Load 30
 - Local display 133
 - Editing view 44

- Navigation view 42
 - see Diagnostic message
 - see In alarm condition
 - see Operational display
- Low flow cut off 123
- M**
- Main electronics module 12
- Maintenance tasks 113
 - Replacing seals 113
- Managing the device configuration 85
- Manufacturer ID 57
- Manufacturing date 14, 15
- Materials 131
- Maximum measured error 125
- Measured variables
 - Calculated 120
 - Measured 120
 - see Process variables
- Measuring and test equipment 113
- Measuring device
 - Configuration 61
 - Conversion 114
 - Design 12
 - Disposal 116
 - Integrating via HART protocol 57
 - Mounting the sensor 24
 - Mounting the ground cable/ground disks 24
 - Mounting the seals 24
 - Screw tightening torques 24
 - Preparing for electrical connection 31
 - Preparing for mounting 23
 - Removing 115
 - Repair 114
 - Switch-on 61
- Measuring principle 120
- Measuring range 120
- Measuring system 120
- Measuring tube specification 130
- Mechanical load 127
- Media 9
- Medium temperature range 127
- Menu
 - Diagnostics 106
 - Operation 91
 - Setup 61, 62
- Menus
 - For measuring device configuration 61
 - For specific settings 79
- Mounting dimensions
 - see Installation dimensions
- Mounting location 19
- Mounting preparations 23
- Mounting requirements
 - Installation dimensions 21
- Mounting tools 23
- N**
- Nameplate
 - Sensor 15
 - Transmitter 14
- Navigation path (navigation view) 42
- Navigation view
 - In the submenu 42
 - In the wizard 42
- Numeric editor 44
- O**
- Operable flow range 121
- Operating elements 46, 100
- Operating keys
 - see Operating elements
- Operating menu
 - Menus, submenus 39
 - Structure 39
 - Submenus and user roles 40
- Operating philosophy 40
- Operation 91
- Operation options 38
- Operational display 41
- Operational safety 10
- Order code 14, 15
- Orientation (vertical, horizontal) 20
- Outlet runs 20
- Output 121
- Output signal 121
- P**
- Packaging disposal 18
- Parameter
 - Changing 50
 - Enter a value 50
- Parameter settings
 - Administration (Submenu) 84, 109
 - Burst configuration 1 to 3 (Submenu) 58
 - Configuration backup display (Submenu) 85
 - Current output 1 (Wizard) 65
 - Data logging (Submenu) 94
 - Device information (Submenu) 110
 - Diagnostics (Menu) 106
 - Display (Submenu) 82
 - Display (Wizard) 73
 - Empty pipe detection (Wizard) 78
 - Low flow cut off (Wizard) 76
 - Operation (Submenu) 93
 - Output conditioning (Wizard) 75
 - Output values (Submenu) 92
 - Process variables (Submenu) 91
 - Pulse/frequency/switch output (Wizard) 67, 69, 71
 - Sensor adjustment (Submenu) 80
 - Setup (Menu) 62
 - Simulation (Submenu) 86
 - System units (Submenu) 63
 - Totalizer (Submenu) 92
 - Totalizer 1 to 3 (Submenu) 80
- Partially filled pipe 19
- Performance characteristics 125
- Post-connection check (checklist) 37

- Post-installation check 61
- Post-installation check (checklist) 28
- Potential equalization 33
- Power consumption 124
- Power supply failure 124
- Pressure loss 129
- Pressure tightness 128
- Pressure-temperature ratings 128
- Process conditions
 - Conductivity 128
 - Flow limit 129
 - Medium temperature 127
 - Pressure loss 129
 - Pressure tightness 128
- Process connections 132
- Product safety 10
- Protecting parameter settings 88
- R**
- Read access 51
- Reading measured values 91
- Recalibration 113
- Reference operating conditions 125
- Registered trademarks 8
- Remedial measures
 - Calling up 101
 - Closing 101
- Remote operation 134
- Repair 114
 - Notes 114
- Repair of a device 114
- Repeatability 126
- Replacement
 - Device components 114
- Replacing seals 113
- Requirements for personnel 9
- Return 115
- S**
- Safety 9
- Screw tightening torques 24
- Sensor
 - Mounting 24
- Serial number 14, 15
- Setting the operating language 61
- Settings
 - Adapting the measuring device to the process conditions 93
 - Administration 84
 - Advanced display configurations 82
 - Current output 65
 - Device reset 109
 - Device tag 62
 - Empty pipe detection (EPD) 78
 - Local display 73
 - Low flow cut off 76
 - Managing the device configuration 85
 - Operating language 61
 - Output conditioning 75
 - Pulse output 67
 - Pulse/frequency/switch output 66, 69
 - Resetting the totalizer 93
 - Sensor adjustment 80
 - Simulation 86
 - Switch output 71
 - System units 63
 - Totalizer 80
 - Totalizer reset 93
- Shock resistance 127
- Showing data logging 94
- Signal on alarm 122
- SIL (functional safety) 135
- SIMATIC PDM 55
 - Function 55
- Software release 57
- Spare part 114
- Spare parts 114
- Special connection instructions 35
- Standards and guidelines 136
- Status area
 - For operational display 41
 - In the navigation view 43
- Status signals 99
- Storage conditions 17
- Storage temperature 17
- Storage temperature range 127
- Structure
 - Operating menu 39
- Submenu
 - Administration 84, 109
 - Advanced setup 79
 - Burst configuration 1 to 3 58
 - Configuration backup display 85
 - Data logging 94
 - Device information 110
 - Display 82
 - Events list 107
 - Operation 93
 - Output values 92
 - Overview 40
 - Process variables 91
 - Sensor adjustment 80
 - Simulation 86
 - System units 63
 - Totalizer 92
 - Totalizer 1 to 3 80
- Supply unit
 - Requirements 30
- Supply voltage 30, 124
- Surface roughness 132
- Symbols
 - For communication 41
 - For correction 44
 - For diagnostic behavior 41
 - For locking 41
 - For measured variable 41
 - For measurement channel number 41
 - For menus 43

- For parameters 43
 - For status signal 41
 - For submenu 43
 - For wizard 43
 - In the status area of the local display 41
 - In the text and numeric editor 44
 - System design
 - Measuring system 120
 - see Measuring device design
 - System integration 57
 - System pressure 21
- T**
- Technical data, overview 120
 - Temperature range
 - Ambient temperature range for display 133
 - Storage temperature 17
 - Terminal assignment 30, 31
 - Terminal voltage 30
 - Terminals 124
 - Text editor 44
 - Tool tip
 - see Help text
 - Tools
 - Electrical connection 29
 - For mounting 23
 - Transport 17
 - Transmitter
 - Connecting the signal cables 31
 - Turning the display module 28
 - Turning the housing 27
 - Transporting the measuring device 17
 - Troubleshooting
 - General 97
 - Turning the display module 28
 - Turning the electronics housing
 - see Turning the transmitter housing
 - Turning the transmitter housing 27
- U**
- Use of the measuring device
 - Borderline cases 9
 - Incorrect use 9
 - see Designated use
 - User roles 40
- V**
- Version data for the device 57
 - Vibration resistance 127
 - Vibrations 22
- W**
- W@M 113, 114
 - W@M Device Viewer 13, 114
 - Weight
 - Compact version 129
 - Transport (notes) 17
 - Wizard
 - Current output 1 65
 - Define access code 88
 - Display 73
 - Empty pipe detection 78
 - Low flow cut off 76
 - Output conditioning 75
 - Pulse/frequency/switch output 67, 69, 71
 - Workplace safety 10
 - Write access 51
 - Write protection
 - Via access code 88
 - Via write protection switch 89
 - Write protection switch 89

www.addresses.endress.com
