

Operating Instructions

Liquiphant FTL31

Point level switch for liquids

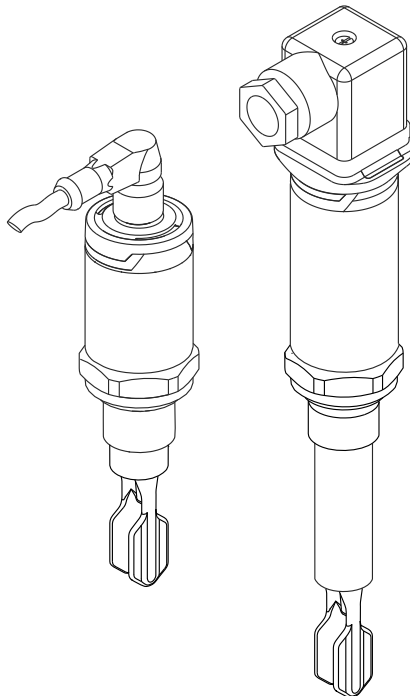

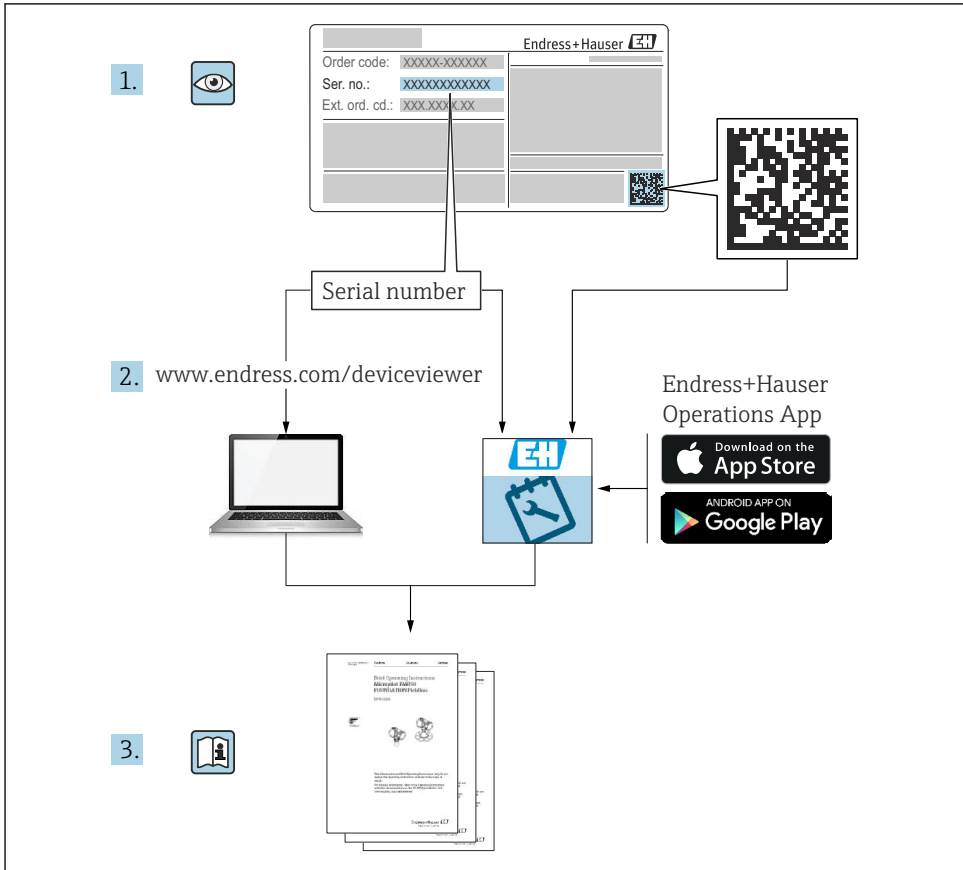

A0023555

Table of contents

1	Document information	4	10	Repair	34
1.1	Document function	4	10.1	Spare parts	34
1.2	Symbols	4	10.2	Return	34
1.3	Documentation	5	10.3	Disposal	34
2	Basic safety instructions	6	11	Accessories	34
2.1	Requirements for the personnel	6	12	Technical data	36
2.2	Intended use	6	12.1	Power supply	36
2.3	Workplace safety	6	12.2	Environment	36
2.4	Operational safety	7	12.3	Process	38
2.5	Product safety	7			
3	Product description	8			
3.1	Product design	8			
4	Incoming acceptance and product identification	9			
4.1	Incoming acceptance	9			
4.2	Product identification	9			
4.3	Manufacturer address	9			
4.4	Storage and transport	9			
5	Mounting	11			
5.1	Mounting requirements	11			
5.2	Mounting the measuring device	16			
5.3	Post-mounting check	17			
6	Electrical connection	18			
6.1	Connecting the device	18			
6.2	Post-connection check	27			
7	Commissioning	29			
7.1	Function check	29			
7.2	LED display	29			
7.3	Function of LEDs	31			
7.4	Function test with test magnet	31			
8	Diagnostics and troubleshooting	33			
8.1	Diagnostic information via LED display	33			
9	Maintenance	33			
9.1	Cleaning	33			





1 Document information

1.1 Document function



These Operating Instructions contain all the information that is required in various phases of the life cycle of the device: from product identification, incoming acceptance and storage, to mounting, connection, operation and commissioning through to troubleshooting, maintenance and disposal.

1.2 Symbols



1.2.1 Safety instructions



Symbol	Meaning
 A0011189-EN	DANGER! This symbol alerts you to a dangerous situation. Failure to avoid this situation will result in serious or fatal injury.
 A0011190-EN	WARNING! This symbol alerts you to a dangerous situation. Failure to avoid this situation can result in serious or fatal injury.
 A0011191-EN	CAUTION! This symbol alerts you to a dangerous situation. Failure to avoid this situation can result in minor or medium injury.
 A0011192-EN	NOTE! This symbol contains information on procedures and other facts which do not result in personal injury.

1.2.2 Electrical symbols

Symbol	Meaning
 A0011200	Ground connection A grounded terminal which, as far as the operator is concerned, is grounded via a grounding system.
 A0011199	Protective ground connection A terminal which must be connected to ground prior to establishing any other connections.

1.2.3 Symbols for certain types of information

Symbol	Meaning
 A0011182	Permitted Indicates procedures, processes or actions that are permitted.
 A0011184	Forbidden Indicates procedures, processes or actions that are forbidden.

Symbol	Meaning
 A0011193	Tip Indicates additional information.
 A0011194	Reference to documentation Refers to the corresponding device documentation.
 A0011195	Reference to page Refers to the corresponding page number.

1.2.4 Symbols for graphics

Symbol	Meaning
1, 2, 3 ...	Item numbers
A, B, C, ...	Views

1.2.5 Symbols for tools

Symbol	Meaning
 A0011222	Open-ended wrench

1.3 Documentation

The document types listed are available in the Download Area of the Endress+Hauser website:
www.endress.com → [Download](#)

Document	Purpose and content of the document
Technical Information TI01147F/00/EN	This document contains all the technical data for the device and provides an overview of the accessories that can be ordered.
Additional documentation TI00426F/00/EN SD00352F/00/A6 SD00356F/00/EN	Weld-in adapter and flanges (overview) Weld-in adapter G 1", G ¾" (installation instructions) Valve plug (installation instructions)

2 Basic safety instructions

2.1 Requirements for the personnel

The personnel performing installation, commissioning, diagnostics and maintenance must satisfy the following requirements:

- Trained, qualified specialists: must have a relevant qualification for this specific function and task
- Are authorized by the plant owner/operator
- Are familiar with federal/national regulations
- Before starting work: read and understand the instructions in the manual and supplementary documentation as well as the certificates (depending on the application)
- Follow instructions and comply with basic conditions

The operating personnel must satisfy the following requirements:

- Are instructed and authorized according to the requirements of the task by the facility's owner-operator
- Follow the instructions in this manual

2.2 Intended use

The measuring device described in this manual may be used only as a point level switch for liquids. Incorrect use may pose a hazard. To ensure that the measuring device remains in perfect condition during the operating time:

- Measuring devices must be used only for media to which the process-wetted materials have an adequate level of resistance.
- Comply with the limit values in the "Technical data" section.

2.2.1 Incorrect use

The manufacturer is not liable for damage caused by improper or non-designated use.

Residual risks

Due to heat transfer from the process, the temperature of the electronics housing and the assemblies contained therein may rise to 80 °C (176 °F) during operation.

Danger of burns from contact with surfaces!

- ▶ In the event of elevated fluid temperatures, ensure protection against contact to prevent burns.

2.3 Workplace safety

For work on and with the device:

- ▶ Wear the required personal protective equipment according to federal/national regulations.
- ▶ Switch off the supply voltage before connecting the device.

2.4 Operational safety

Danger of injury!

- ▶ Operate the device only if it is in proper technical condition, free from errors and faults.
- ▶ The operator is responsible for the interference-free operation of the device.

2.5 Product safety

This measuring device is designed in accordance with good engineering practice to meet state-of-the-art safety requirements, has been tested, and left the factory in a condition in which it is safe to operate. It meets the general safety standards and legal requirements. It also complies with the EC directives listed in the device-specific EC Declaration of Conformity. Endress+Hauser confirms this by affixing the CE mark to the device.

3 Product description

The Liquiphant FTL31 is a point level switch for universal use in all liquids. It is used preferably in storage tanks, mixing vessels and pipes.

3.1 Product design

The point level switch is available in different versions, which can be assembled in accordance with user specifications. Examples in the graphic below:

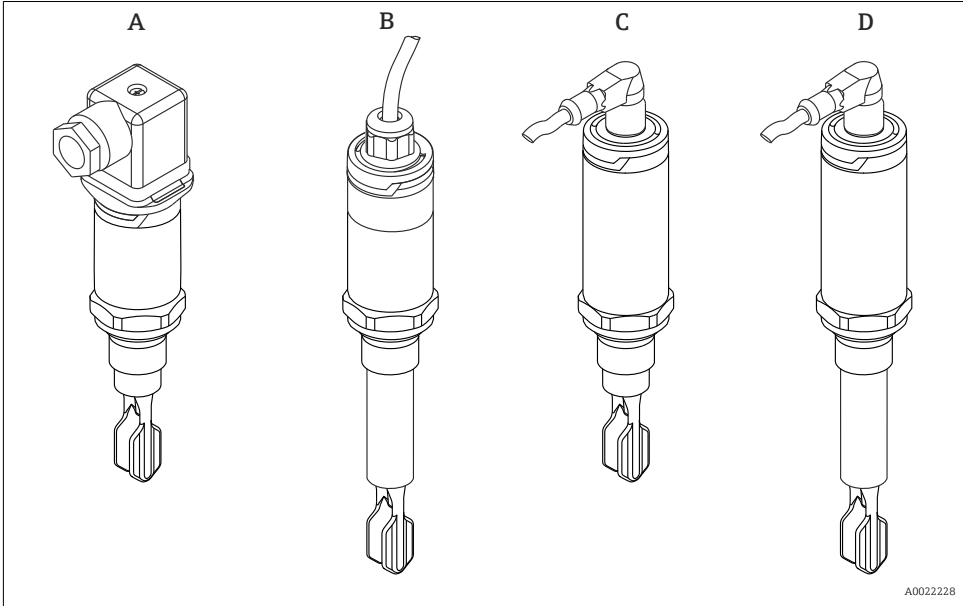

Versions	Examples			
	A	B	C	D
Electrical connection	Valve plug	Cable (cannot be disassembled)	M12 plug for housing cover IP66/68/69K	M12 plug for housing cover IP65/67
Housing (sensor design) for process temperatures up to:	100 °C (212 °F)	100 °C (212 °F)	150 °C (302 °F)	150 °C (302 °F)
Sensor type	Compact version	Short tube version	Compact version	Short tube version

 For detailed information on the short tube version and the process connections, see the Technical Documentation TI01147F/00/EN.

4 Incoming acceptance and product identification

4.1 Incoming acceptance

Check the following during incoming acceptance:

- Are the order codes on the delivery note and the product sticker identical?
- Are the goods undamaged?
- Do the nameplate data match the ordering information on the delivery note?
- If required (see nameplate): Are the safety instructions (XA) provided?



If one of these conditions is not met, please contact the manufacturer's sales office.

4.2 Product identification

The following options are available for the identification of the measuring device:

- Nameplate specifications
- Extended order code with breakdown of the device features on the delivery note
- ▶ Enter the serial number from the nameplates into *W@M Device Viewer* (www.endress.com/deviceviewer)
 - ↳ All the information about the measuring device and the scope of the associated Technical Documentation are displayed.
- ▶ Enter the serial number from the nameplate into the *Endress+Hauser Operations App* or use the *Endress+Hauser Operations App* to scan the 2-D matrix code (QR Code) provided on the nameplate
 - ↳ All the information about the measuring device and the scope of the associated Technical Documentation are displayed.

4.3 Manufacturer address

Endress+Hauser SE+Co. KG
Hauptstraße 1
79689 Maulburg, Germany

Place of manufacture: See nameplate.

4.4 Storage and transport

4.4.1 Storage conditions

- Permitted storage temperature: -40 to +85 °C (-40 to +185 °F)
- Use original packaging.

4.4.2 Transporting the product to the measuring point

Transport the device to the measuring point in the original packaging.

4.4.3 Handling of the device

NOTICE

Risk of injury! Housing or fork may become damaged or tear!

- ▶ Transport the device to the measuring point in its original packaging or by the housing.
- ▶ Do not hold the device by the fork!
- ▶ Do not use the device as a ladder or climbing aid!
- ▶ Do not bend the fork!
- ▶ Do not shorten or lengthen the fork!

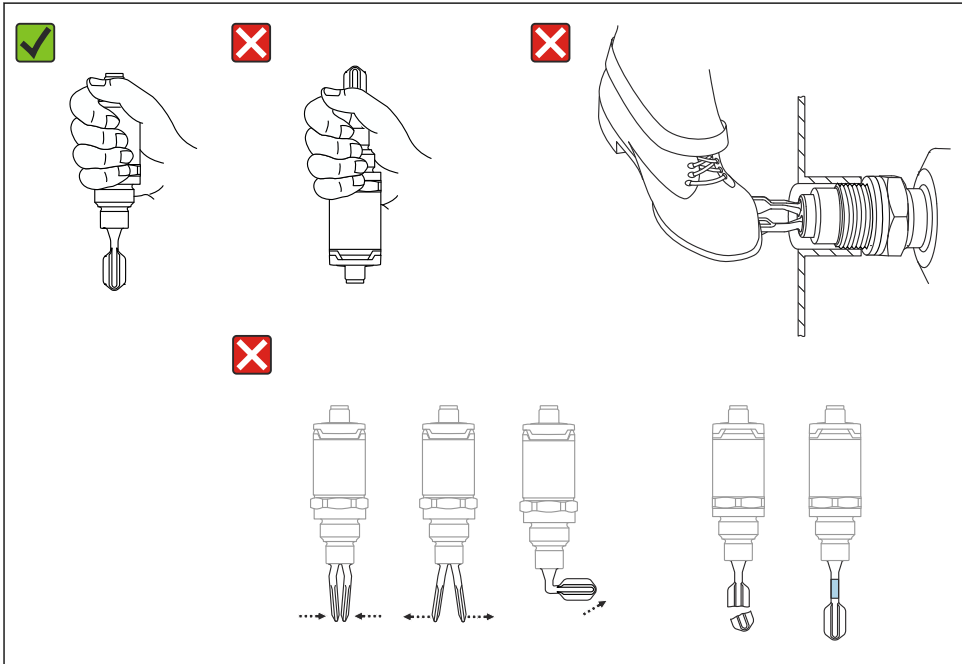

A0020845

1 Handling of the device

5 Mounting

5.1 Mounting requirements

5.1.1 Orientation

Installation is possible in any position in a vessel, pipe or tank.

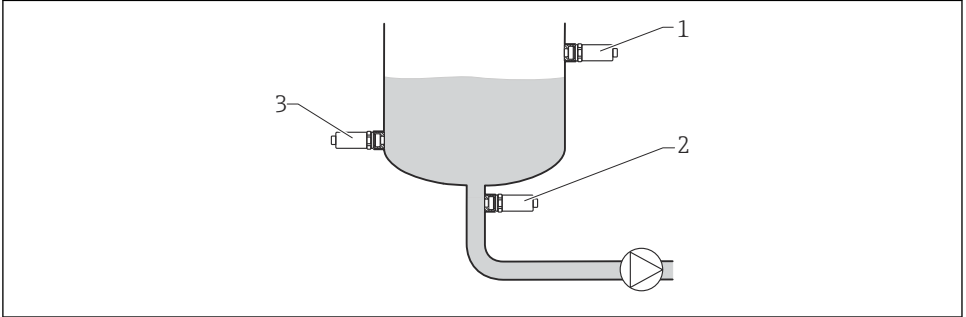

A0036961

2 Installation examples

- 1 Overfill prevention or upper level detection (maximum safety)
- 2 Dry running protection for pump (minimum safety)
- 3 Lower level detection (minimum safety)

5.1.2 Switch point

The switch point **A** on the sensor depends on the orientation of the point level switch (water +25 °C (+77 °F), 1 bar (14.5 psi)).

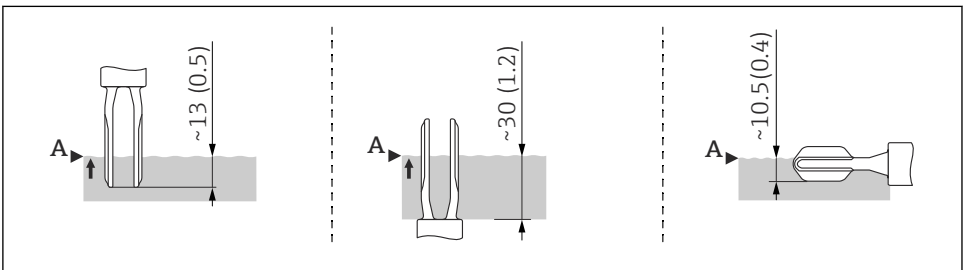

A0020734

3 Orientation: vertical from above, vertical from below, horizontal; dimensions in mm (in)

5.1.3 Viscosity

Switching delays may occur in the case of highly viscous liquids. Make sure that the liquid can easily run off the tuning fork:

- If installing in vessels with high-viscosity liquids (A), the tuning fork may **not** be located in the installation socket!
- If installing in vessels with low-viscosity liquids (B), the tuning fork may be located in the installation socket.
- The installation nozzle must be no less than the minimum diameter of 50 mm (2.0 in).

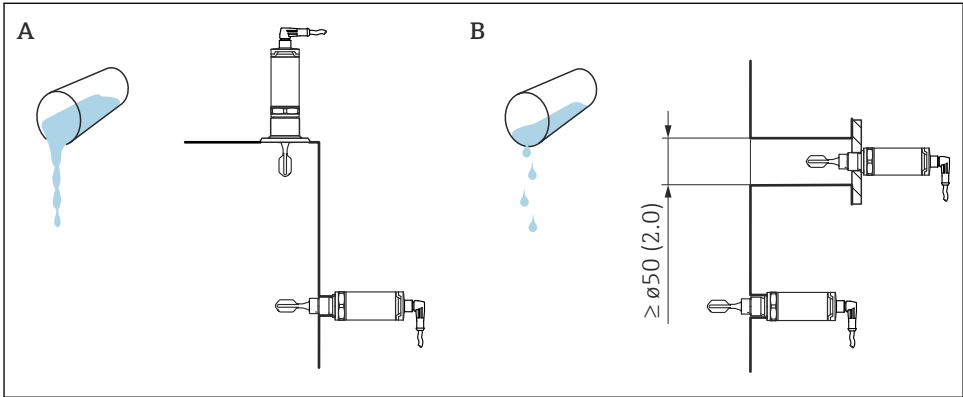

A0022054

4 Installation options with consideration given to the liquid viscosity, dimensions in mm (in)

A High viscosity ($< 10\,000\text{ mPa}\cdot\text{s}$)

B Low viscosity ($< 2\,000\text{ mPa}\cdot\text{s}$)

5.1.4 Buildup

Make sure that the installation socket does not exceed a certain length so that the tuning fork can project freely into the vessel.

Possibilities for optimization:

- A vertical orientation of the point level switch keeps buildup to a minimum.
- Preferably flush-mounted on vessels or in pipes.

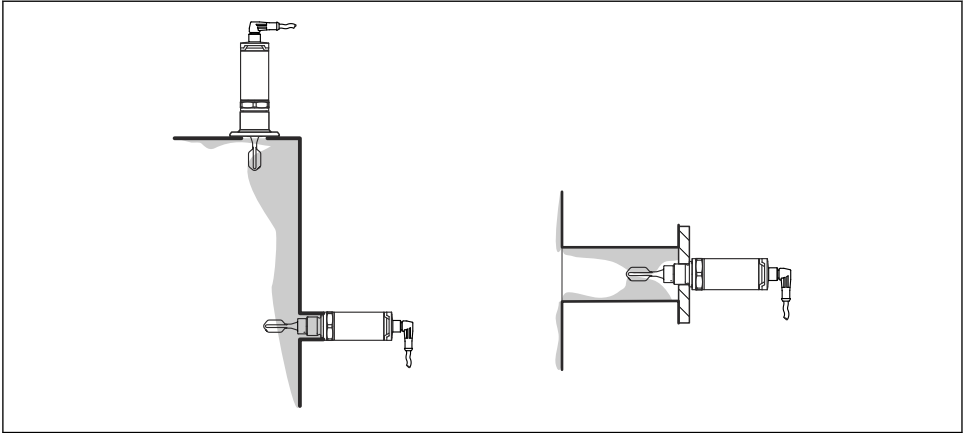

A0022057

5 *Buildup on tank wall, pipe wall and tuning fork*

5.1.5 Weld-in adapter with leakage hole

If installed horizontally, make sure that the leakage hole is pointing down. This allows leaks to be detected as quickly as possible.

5.1.6 Marking

The marking indicates the position of the tuning fork. If installed horizontally in vessels, the marking is face up.

The marking is either a material specification (e.g. 316L) or a type of thread (e.g. G 1/2") and is located:

- On the hexagonal bolt of the process adapter
- On the nameplate
- On the weld-in adapter

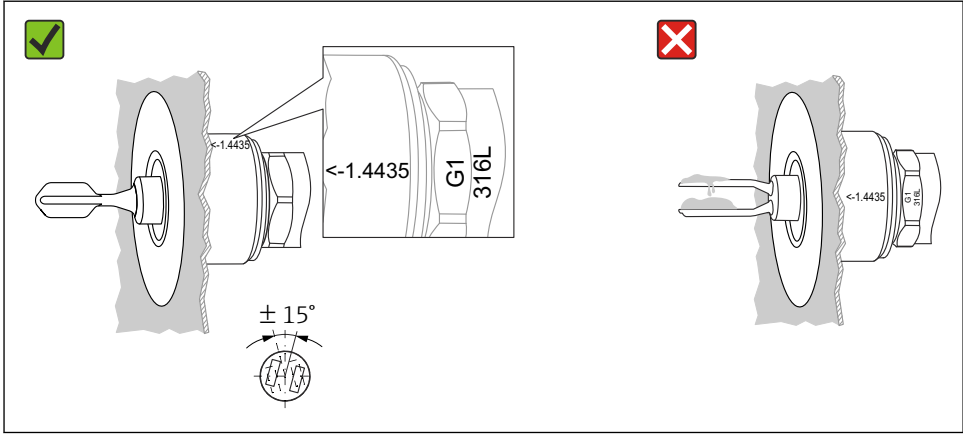

A0022641

6 Orientation in the vessel

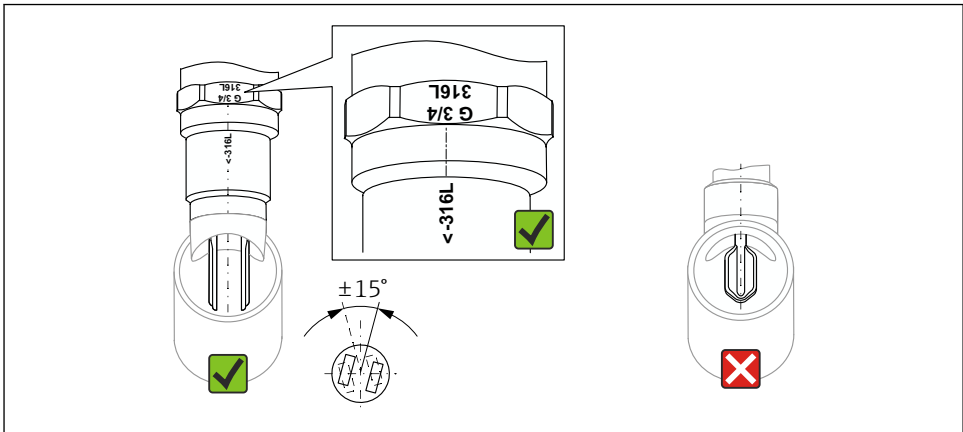

A0022804

7 Orientation in the pipe

5.1.7 Installation in pipes

During installation, pay attention to the position of the fork in order to minimize turbulence in the pipe.

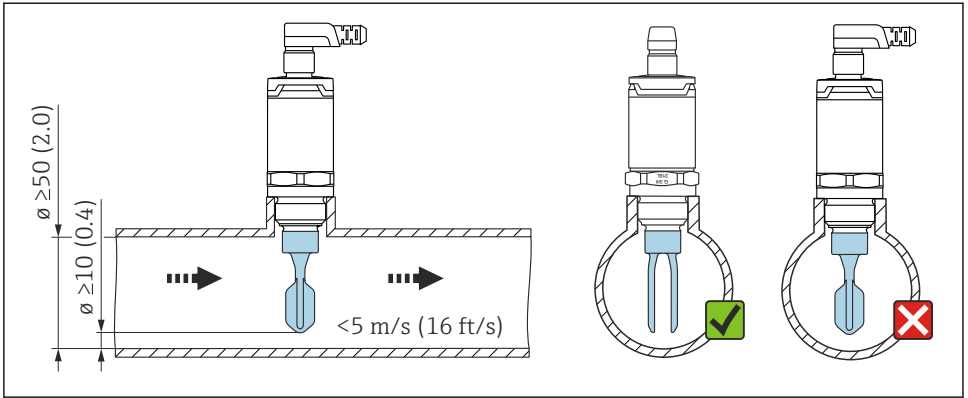

A0021357

8 Position of the tuning fork in pipes. Unit of measurement mm (in)

5.1.8 Installation in vessels

If installed horizontally, pay attention to the position of the tuning fork to ensure that the liquid can drip off.

The electrical connection, e.g. M12 plug, should be established with the cable pointing downwards. This can prevent moisture from penetrating.

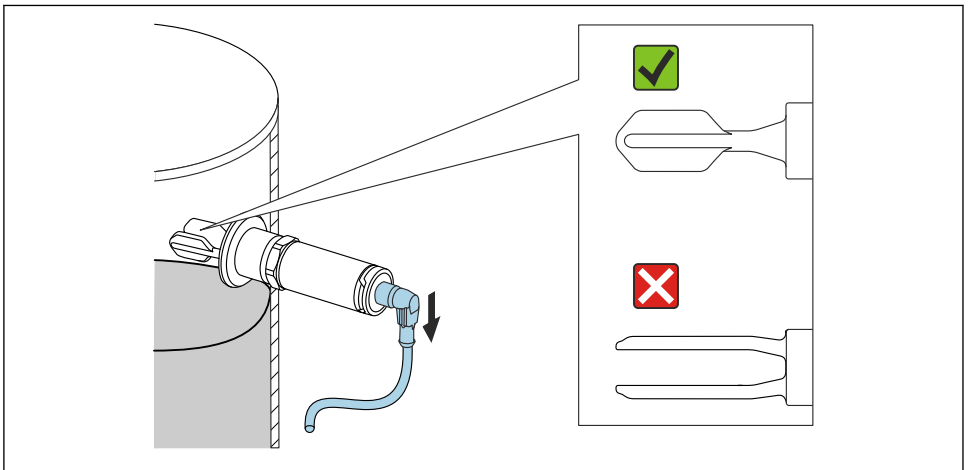

A0021034

9 Position of the fork in the case of horizontal installation in a vessel

5.1.9 Distance from wall

Ensure that there is sufficient distance between the expected buildup on the tank wall and the fork. Recommended distance from wall $\geq 10 \text{ mm (0.39 in)}$.

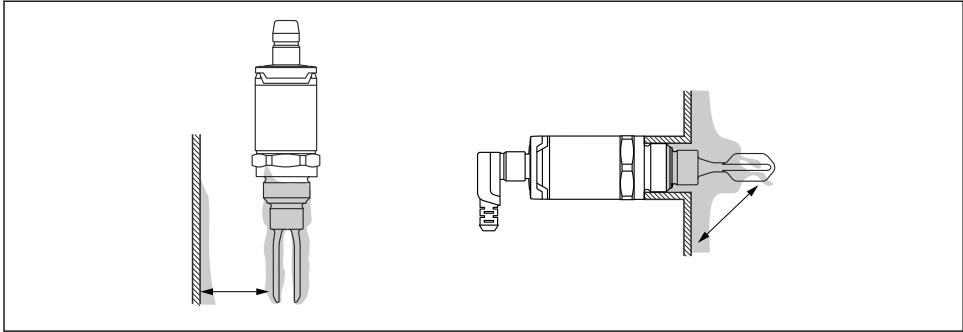

A0022272

5.2 Mounting the measuring device



i Use in accordance with WHG: Prior to mounting the device, pay attention to the WHG approval documents. The documents can be found in the Download Area of the Endress +Hauser website: www.endress.com → [download](#)

5.2.1 Required tools

- Open-ended wrench: only turn by the hex bolt when screwing in.
Maximum torque: $\leq 30 \text{ Nm}$ (22 lbf ft).
- Socket wrench: the socket wrench AF32 is available as an accessory → 34.

i Pay attention to the temperature and pressure specifications for seals used at the customer site.

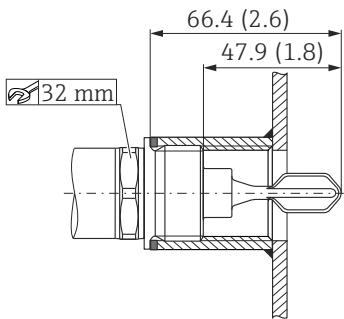
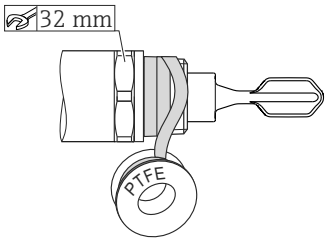
View, dimensions in mm (in)	Description
<p style="text-align: center;">A0023245</p> <p>1 Flat seal 2 Weld-in adapter</p>	<p>Thread accessory weld-in adapter</p> <p>Example G 3/4" (example in graphic on left)</p> <ul style="list-style-type: none"> ▪ L1: 63.9 mm (2.52 in) ▪ L2: 38.0 mm (1.5 in) <p>G 1"</p> <ul style="list-style-type: none"> ▪ L1: 66.4 mm (2.61 in) ▪ L2: 48.0 mm (1.89 in) <p>Pressure and temperature (maximum): +25 bar (+362 psi) at +150 °C (+302 °F) +40 bar (+580 psi) at +100 °C (+212 °F)</p> <p>i When using a weld-in adapter with flush-mounted seal, the flat seal (1) supplied must be removed from the thread.</p>

View, dimensions in mm (in)	Description
 <p>A0022026</p>	<p>Metric thread in customer nozzle Example G 1"</p> <p>Pressure and temperature (maximum): +40 bar (+580 psi) at 150 °C (302 °F)</p>
 <p>A0022028</p>	<p>NPT thread (ANSI B 1.20.1)</p> <p>Pressure and temperature (maximum): +40 bar (+580 psi) at +150 °C (+302 °F)</p> <p> Wrap in sealing material if necessary.</p>

5.3 Post-mounting check

- Is the device undamaged (visual inspection)?
- Does the measuring device meet the measuring point specifications?

For example:

- Process temperature
- Process pressure
- Ambient temperature
- Switch point

- Are the measuring point identification and labeling correct (visual inspection)?
- Is the device adequately protected from wet conditions and direct sunlight?
- Is the device properly secured?

6 Electrical connection

The device has two operating modes: maximum safety (MAX) and minimum safety (MIN). By choosing the corresponding operating mode, the user ensures that the device also switches in a safety-oriented manner even in an alarm condition, e.g. if the power supply line is disconnected.

- **Maximum safety (MAX)**

The device keeps the electronic switch closed as long as the liquid level is below the fork.

Sample application: overflow protection

- **Minimum safety (MIN)**

The device keeps the electronic switch closed as long as the fork is immersed in liquid.

Sample application: Dry running protection for pumps

The electronic switch opens if the limit is reached, if a fault occurs or the power fails (quiescent current principle).

6.1 Connecting the device



In accordance with IEC/EN61010 a suitable circuit breaker must be provided for the device.

6.1.1 Electronic version 3-wire DC-PNP

3-wire DC-PNP is preferably used in conjunction with programmable logic controllers (PLC), DI modules as per EN 61131-2. Positive signal at the switch output of the electronics (PNP).

Voltage source: non-hazardous contact voltage or Class 2 circuit (North America).

Connection with M12 plug

Depending on the analysis of the switch outputs, the device works in the MAX (maximum safety) or MIN (minimum safety) mode.



A cable is optionally available



A0022901

 10 M12 plug

Maximum safety										
Terminal assignment	MAX output	Yellow LED (ye)								
Wire colors for M12 plug: <ul style="list-style-type: none"> ▪ 1 = BN (brown) ▪ 2 = WT (white) ▪ 3 = BU (blue) ▪ 4 = BK (black) 										
<table border="0"> <thead> <tr> <th>Symbols</th> <th>Description</th> </tr> </thead> <tbody> <tr> <td></td> <td>Yellow LED (ye) lit</td> </tr> <tr> <td></td> <td>Yellow LED (ye) not lit</td> </tr> <tr> <td>K</td> <td>External load</td> </tr> </tbody> </table>			Symbols	Description		Yellow LED (ye) lit		Yellow LED (ye) not lit	K	External load
Symbols	Description									
	Yellow LED (ye) lit									
	Yellow LED (ye) not lit									
K	External load									

Minimum safety										
Terminal assignment	MIN output	Yellow LED (ye)								
Wire colors for M12 plug: <ul style="list-style-type: none"> ▪ 1 = BN (brown) ▪ 2 = WT (white) ▪ 3 = BU (blue) ▪ 4 = BK (black) 										
<table border="0"> <thead> <tr> <th>Symbols</th> <th>Description</th> </tr> </thead> <tbody> <tr> <td></td> <td>Yellow LED (ye) lit</td> </tr> <tr> <td></td> <td>Yellow LED (ye) not lit</td> </tr> <tr> <td>K</td> <td>External load</td> </tr> </tbody> </table>			Symbols	Description		Yellow LED (ye) lit		Yellow LED (ye) not lit	K	External load
Symbols	Description									
	Yellow LED (ye) lit									
	Yellow LED (ye) not lit									
K	External load									

Function monitoring with M12 plug

Using a two-channel analysis, function monitoring of the sensor can be implemented in addition to level monitoring, e.g. per relay switch, PLC, AS-i Bus I/O module.

When both outputs are connected, the MIN and MAX outputs assume opposite states (XOR) when the device is operating fault-free. In the event of an alarm condition or a line break, both outputs are de-energized.

Connection for function monitoring using XOR operation		Yellow LED (ye)	LED red (rd)	
	Sensor covered	Max output 1 / 2		
		Min output 1 / 4		
	Sensor not covered	Max output 1 / 2		
		Min output 1 / 4		
	Fault	1 / 2		
		1 / 4		
Wire colors for M12 plug: <ul style="list-style-type: none"> ■ 1 = BN (brown) ■ 2 = WT (white) ■ 3 = BU (blue) ■ 4 = BK (black) 				
Symbols 		Description LED lit LED not lit Fault or warning External load		

Connection with valve plug

Depending on the assignment of the connector or the wiring of the cable, the device works in either the MAX or MIN operating mode.

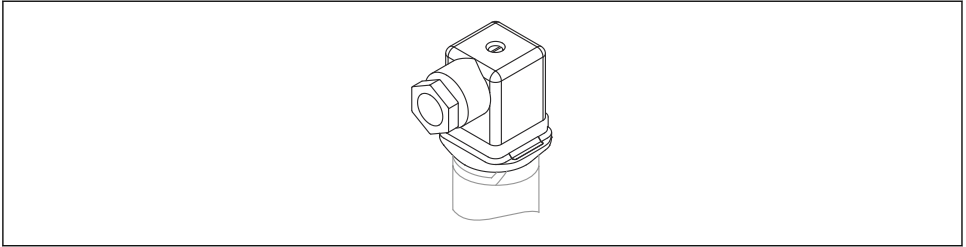

A0022900

11 Valve plug

3-wire DC-PNP		
Terminal assignment	MAX operating mode	Yellow LED (ye)
Symbols Yellow LED (ye) lit Yellow LED (ye) not lit K	Description Yellow LED (ye) lit Yellow LED (ye) not lit External load	

3-wire DC-PNP		
Terminal assignment	MIN operating mode	Yellow LED (ye)
Symbols Yellow LED (ye) lit Yellow LED (ye) not lit K	Description Yellow LED (ye) lit Yellow LED (ye) not lit External load	

Connection with cable

Depending on the assignment of the connector or the wiring of the cable, the device works in either the MAX or MIN operating mode.

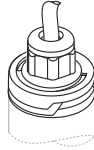



A0022902

12 Cable (cannot be disassembled)

3-wire DC-PNP		
Terminal assignment	MAX operating mode	Yellow LED (ye)
<p>Wire colors: 1 = BK (black) 2 = GR (gray) 3 = BN (brown) Ground = GNYE (green-yellow)</p>		
<p>Symbols Description</p> <p> Yellow LED (ye) lit</p> <p> Yellow LED (ye) not lit</p> <p>K External load</p>		

3-wire DC-PNP		
Terminal assignment	MIN operating mode	Yellow LED (ye)

3-wire DC-PNP		
Terminal assignment	MIN operating mode	Yellow LED (ye)
Wire colors: 1 = BK (black) 2 = GR (gray) 3 = BN (brown) Ground = GNYE (green-yellow)		
Symbols	Description	
	Yellow LED (ye) lit	
	Yellow LED (ye) not lit	
K	External load	

6.1.2 Electronic version 2-wire AC/DC

The load is switched via an electronic switch directly in the power supply circuit. Always connect in series with a load!

Not suitable for connection to low-voltage PLC inputs!

Selection tool for relays

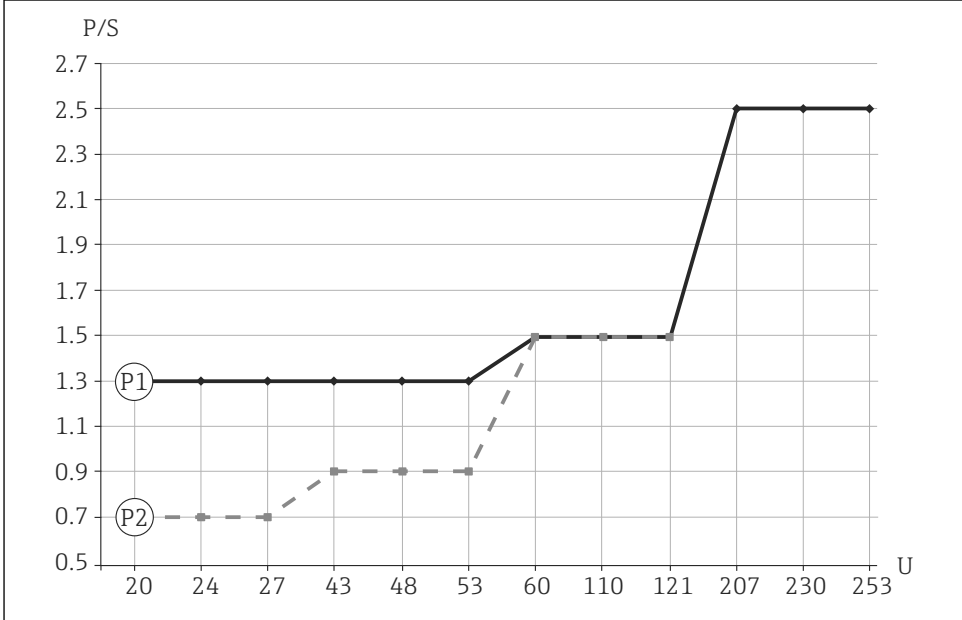

A0023486

13 Minimum rated power of the load

P/S Rated power in [W] / [VA]

U Operating voltage in [V]

P1: AC mode

Relay operating voltage: Relay rated power

- 24 V: 1.3 to 6 VA
- 110 V: 1.5 to 27.5 VA
- 230 V: 2.5 to 57.5 VA

P2: DC mode

Relay operating voltage: Relay rated power

- **24 V:** 0.7 to 6 W
- **48 V:** 0.9 to 12 W
- **60 V:** 1.5 to 15 W

 Relays with a lower rated power can be operated by means of an RC module connected in parallel (optional).





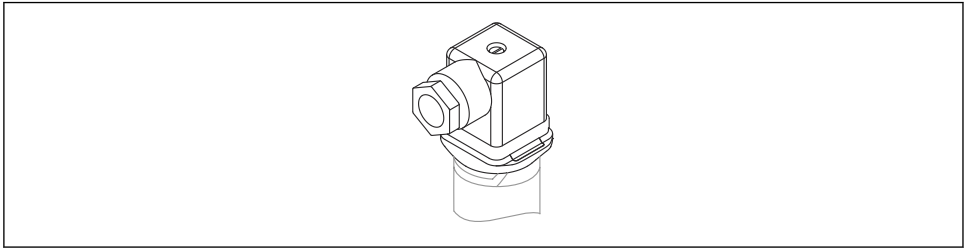

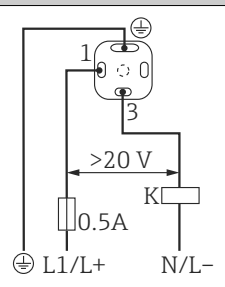

Connection with valve plug

Depending on the assignment of the connector or the wiring of the cable, the device works in either the MAX or MIN operating mode.



A0022900

 14 Valve plug

2-wire AC/DC		
Terminal assignment	MAX operating mode	Yellow LED (ye)
 <p style="text-align: right;">A0021219</p>	  <p style="text-align: right;">A0045072</p>	
	  <p style="text-align: right;">A0045074</p>	
Symbols   K	Description Yellow LED (ye) lit Yellow LED (ye) not lit External load	

2-wire AC/DC		
Terminal assignment	MIN operating mode	Yellow LED (ye)
Symbols 	Description Yellow LED (ye) lit Yellow LED (ye) not lit External load	

Connection with cable

Depending on the assignment of the connector or the wiring of the cable, the device works in either the MAX or MIN operating mode.

When the cable is wired, one wire of the cable does not have any function in each of the operating modes (brown in the case of MIN, and gray in the case of MAX). The cable with no function must be secured against inadvertent contact.

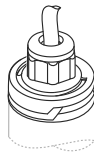

A0022902

15 Cable (cannot be disassembled)

2-wire AC/DC		
Terminal assignment	MAX operating mode	Yellow LED (ye)
<p style="text-align: right;">A0022161</p>		
<p>Wire colors: 1 = BK (black) 2 = GR (gray) 3 = BN (brown) Ground = GNYE (green-yellow)</p>		
<p>Symbols</p> <p> Description Yellow LED (ye) lit</p> <p> Description Yellow LED (ye) not lit</p> <p> Description External load</p>		

2-wire AC/DC		
Terminal assignment	MIN operating mode	Yellow LED (ye)
<p style="text-align: right;">A0022225</p>		
<p>Wire colors: 1 = BK (black) 2 = GR (gray) 3 = BN (brown) Ground = GNYE (green-yellow)</p>		
<p>Symbols</p> <p> Description Yellow LED (ye) lit</p> <p> Description Yellow LED (ye) not lit</p> <p> Description External load</p>		

6.2 Post-connection check

Are the device and cables free from damage (visual check)?

- Does the supply voltage match the specifications on the nameplate?
- Do the cables used comply with the requirements?
- Do the mounted cables have adequate strain relief?
- Are the cable glands mounted and firmly tightened?
- Is the wiring correct?
- 3-wire DC-PNP: If required, is the functional earth connected?
- 2-wire AC/DC: Has the protective ground connection been established?
- If supply voltage is present, is the green LED lit?

7 Commissioning

7.1 Function check

Go through the following checklists before commissioning:

- "Post-installation check" checklist
- "Post-connection check" checklist



The function of the tuning fork can be tested by immersing the tuning fork in a vessel containing water.

7.2 LED display

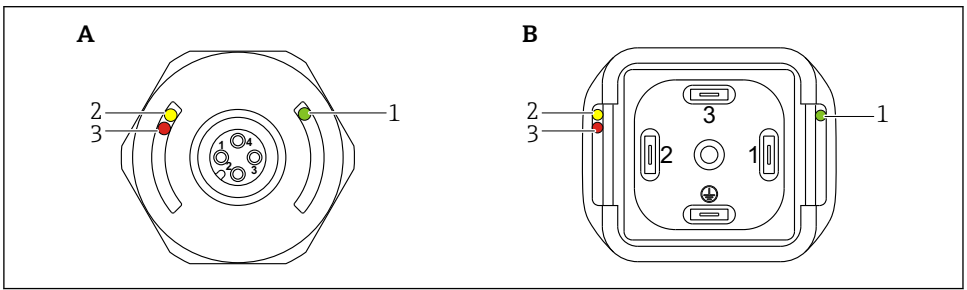

A0016856

A M12 plug, (cable without graphic)

B Valve plug

1 Green LED (gn)

2 Yellow LED (ye)

3 LED red

Function	Description
Green LED (gn) Lit	Device is operational
Yellow LED (ye) Lit	<p>M12 plug Indicates the sensor state: tuning fork is covered by liquid</p> <p>Valve plug / cable Indicates the switching state:</p> <ul style="list-style-type: none"> ▪ MAX operating mode (overflow protection): sensor is not covered by liquid ▪ MIN operating mode (dry running protection): the sensor is covered by liquid

Function	Description
LED red (rd) Flashing	Warning/maintenance required: error can be rectified, e.g. incorrect wiring; protective function if test magnet is held against the sensor for longer than 30 s
LED red (rd) Lit	Fault/device failure: error cannot be rectified, e.g. electronic error

 On the metal housing cover (IP69), there is no external signaling via LEDs.

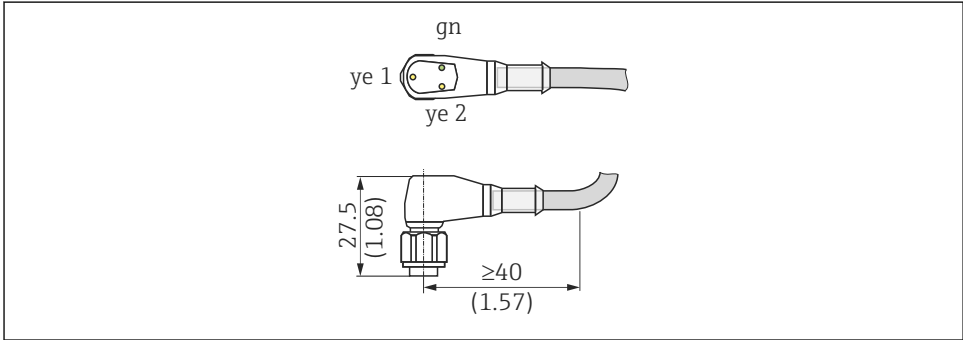

















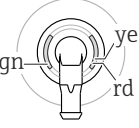





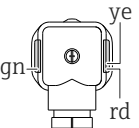

A0020871

Description of M12 plug with LED display (optional)

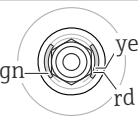
- LED gn: is lit when the supply voltage is applied
- LED ye 1: is lit when the sensor is covered
- LED ye 2: is lit when the sensor is **not** covered

 The connecting cable with an M12 plug and LED display can be optionally ordered as an accessory. See the "Accessories" section

7.3 Function of LEDs

Connection	Operating modes					
	Maximum safety (MAX)		Minimum safety (MIN)		Warning	Fault
1 						
2 						
3 						
4 						
A0023003	A0023004	A0023005	A0023006	A0023007	A0023008	A0023009
1: Level display 2: M12 plug 3: Valve plug 4: Cable			● not lit ☀ lit ⚡ flashing ⚡ fault/warning			
LED colors: gn = green, ye = yellow, rd = red						

7.4 Function test with test magnet

WARNING

Danger of injury!

- ▶ Ensure that no dangerous processes are triggered in the system.

Carry out a function test while the device is in operation.

- ▶ Hold the test magnet for at least 2 s against the marking on the housing.
 - ↳ This inverts the current switch status, and the yellow LED changes state. When the magnet is removed, the switching status valid at that time is adopted.

If the test magnet is held against the marking for longer than 30 s, the red LED will flash: the device returns automatically to the current switch status.

 The test magnet is not included in the scope of delivery. It can optionally be ordered as an accessory. See the "Accessories" -> "Additional accessories" section

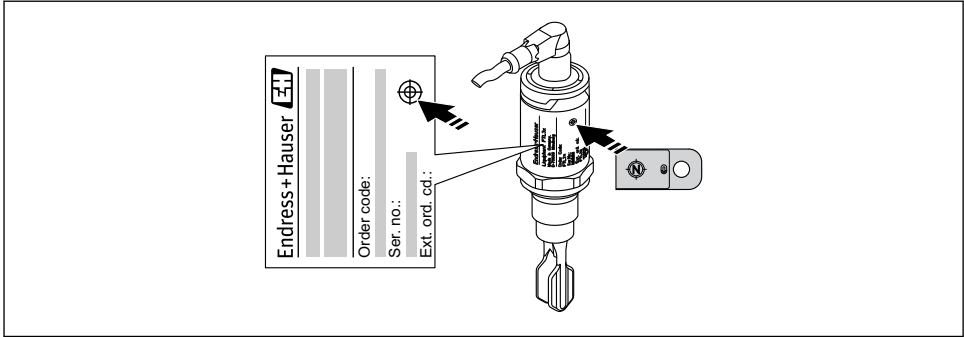

A0020960

16 Position for test magnet on housing

8 Diagnostics and troubleshooting

8.1 Diagnostic information via LED display

LED display on housing cover

Malfunction	Possible cause	Corrective action
Green LED Not lit	No power supply	Check connector, cable and power supply
Red LED Flashing	Overload or short-circuit in load circuit	<ul style="list-style-type: none"> ▪ Rectify short-circuit ▪ Reduce maximum load current to below 250 mA
Red LED Lit	Internal sensor failure or sensor corroded	Replace device

Connection: 2-wire AC/DC to 20 to 253 V DC

Malfunction	Possible cause	Corrective action
Unexpected behavior of yellow LED	Incorrect connector assignment or incorrect cable wiring	<p>Pay attention to the polarity of the power supply!</p> <p>Correct connection: Valve plug: L+ to PIN1, L- to PIN 3 Cable: L+ BK (black), L- BN (brown)</p> <p>Result (for MIN operating mode)</p> <ul style="list-style-type: none"> ▪ Tuning fork covered: yellow LED lit. ▪ Tuning fork not covered: yellow LED not lit. <p>Result (for MAX operating mode)</p> <ul style="list-style-type: none"> ▪ Tuning fork covered: yellow LED not lit. ▪ Tuning fork not covered: yellow LED lit.

9 Maintenance

No special maintenance work is required.

9.1 Cleaning

The sensor must be cleaned if necessary. It can also be cleaned while installed (e.g. CIP Cleaning in Place / SIP Sterilization in Place). Care must be taken to ensure that no damage occurs to the sensor in the process.

10 Repair

Repair is not envisaged for the point level switch.

10.1 Spare parts

The website for the W@M Device Viewer (www.endress.com/deviceviewer): All spare parts for the measuring device are listed here together with the order code and can be ordered here. If available, users can also download the associated Installation Instructions.

10.2 Return

The requirements for safe device return can vary depending on the device type and national legislation.

1. Refer to the website for more information:
<http://www.endress.com/support/return-material>
2. Return the device if repairs or a factory calibration are required, or if the wrong device was ordered or delivered.



10.3 Disposal



If required by the Directive 2012/19/EU on waste electrical and electronic equipment (WEEE), our products are marked with the depicted symbol in order to minimize the disposal of WEEE as unsorted municipal waste. Such products may not be disposed of as unsorted municipal waste and can be returned to Endress+Hauser for disposal at conditions stipulated in our General Terms and Conditions or as individually agreed.

11 Accessories

 For detailed information on accessories, see the Technical Documentation TI01147F.

Designation	Additional information
Weld-in adapter	 For detailed information on the weld-in adapters, see TI00426F/00/EN and the supplementary documentation →  5.
Seals, O-rings	

Designation	Additional information
Plug-in jack M12 with cable 5 m (16 ft)	<ul style="list-style-type: none"> ■ IP69K, coupling nut 316L <ul style="list-style-type: none"> ■ Angled with LED, order number: 52018763 ■ Angled without LED, order number: 52024216 ■ IP67, coupling nut (Cu Sn/Ni) <ul style="list-style-type: none"> ■ Angled, order number: 52010285 ■ Straight, order number: 52006263 <p> Wire colors:</p> <ul style="list-style-type: none"> ■ 1 = BN (brown) ■ 2 = WT (white) ■ 3 = BU (blue) ■ 4 = BK (black)
Socket wrench for mounting	Hexagon bolt, AF32, order number: 52010156
Test magnet	Order number: 71267011

12 Technical data

 For additional information on the technical data, see the Technical Documentation TI01147F/00/EN.

12.1 Power supply

Electronic version	Supply voltage	Power consumption	Current consumption
3-wire DC-PNP	10 to 30 V DC	< 975 mW	< 15 mA
2-wire AC/DC	20 to 253 V	< 850 mW	< 3.8 mA

12.2 Environment

Ambient temperature range	-40 to +70 °C (-40 to +158 °F), see derating →  37
Storage temperature	-40 to +85 °C (-40 to +185 °F)
Climate class	DIN EN 60068-2-38/IEC 68-2-38: test Z/AD
Operating altitude	Up to 2 000 m (6 600 ft) above sea level
Shock resistance	a = 300 m/s ² = 30 g, 3 axes x 2 directions x 3 shocks x 18 ms, as per test Ea, prEN 60068-2-27:2007
Vibration resistance	a(RMS) = 50 m/s ² , ASD = 1.25 (m/s ²) ² /Hz, f = 5 to 2 000 Hz, t = 3 x 2 h, as per test Fh, EN 60068-2-64:2008
Reverse polarity protection	<p>2-wire AC/DC</p> <ul style="list-style-type: none"> ▪ AC mode: the device has reverse polarity protection. ▪ DC mode: in the event of reverse polarity the maximum safety mode is always detected. Check the wiring and perform a function check before commissioning. The device is not damaged in the event of reverse polarity. <p>3-wire DC-PNP Integrated. In the event of reverse polarity, the device is deactivated automatically.</p>
Short-circuit protection	<p>2-wire AC/DC During switching the sensor checks whether a load, e.g. relay or contactor, is present (load check). If an error occurs, the sensor is not damaged. Smart monitoring: normal operation is resumed once the error is fixed.</p> <p>3-wire DC-PNP Overload protection/short-circuit protection at I > 250 mA; the sensor is not destroyed. Intelligent monitoring: Testing for overload at intervals of approx. 1.5 s; normal operation resumes once the overload/short-circuit has been rectified.</p>

Degree of protection	<ul style="list-style-type: none"> ▪ IP65/67 NEMA Type 4X Enclosure (M12 plug) ▪ IP65 NEMA Type 4X Enclosure (valve plug) ▪ IP66/68 NEMA Type 4X/6P Enclosure (cable) ▪ IP66/68/69K NEMA Type 4X/6P Enclosure (M12 plug for metal housing cover)
Electromagnetic compatibility	<p>Electromagnetic compatibility in accordance with all relevant requirements of the EN 61326 series and NAMUR recommendation EMC (NE21). For details, refer to the EC Declaration of Conformity.</p> <p>Available in the Download Area of the Endress+Hauser website: www.endress.com.</p>

12.2.1 Derating

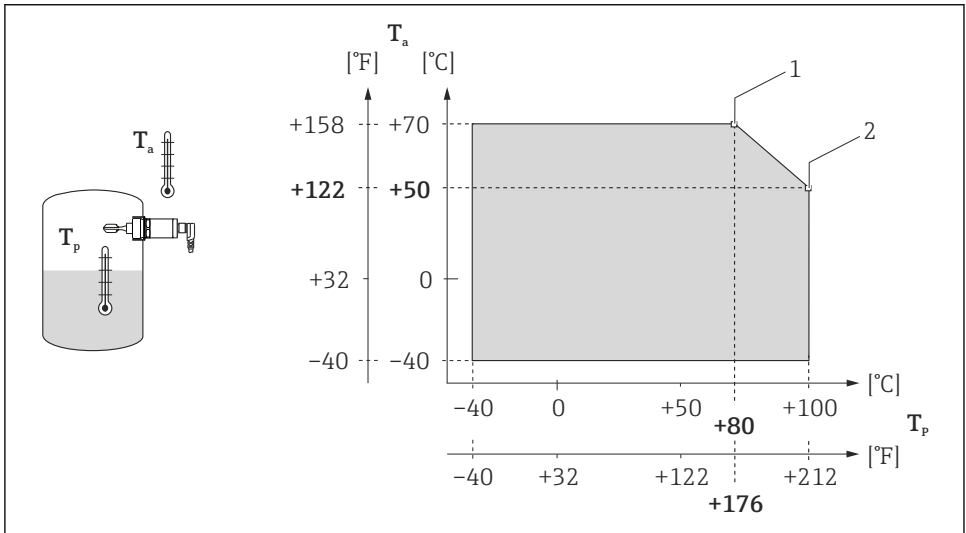

A0022002

17 Derating curve: 100 °C (212 °F)

1 I_{max} : 200 mA (DC-PNP), 250 mA (AC/DC)

2 I_{max} : 150 mA (DC-PNP), 150 mA (AC/DC)

T_a Ambient temperature

T_p Process temperature

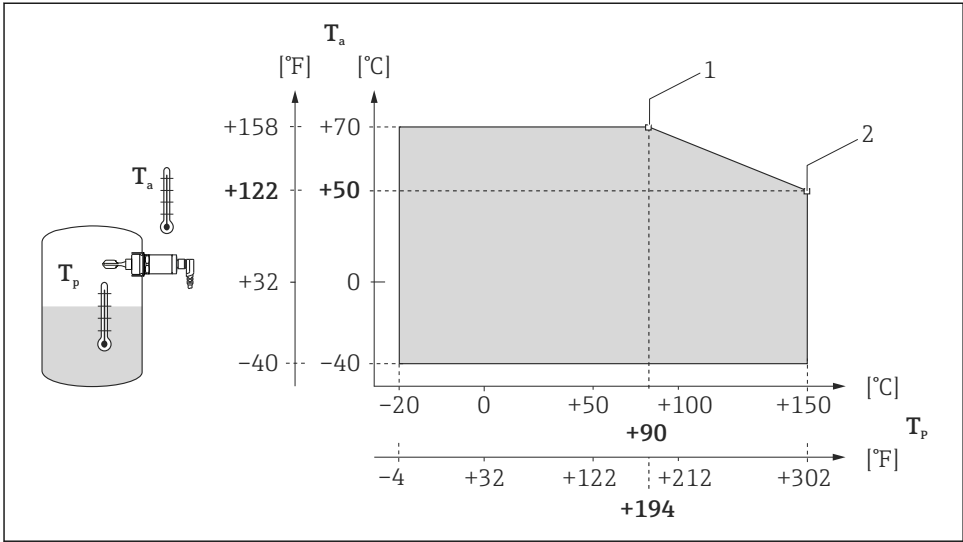

A0020869

18 Derating curve: 150 °C (302 °F)

1 I_{max} : 200 mA (DC-PNP), 250 mA (AC/DC)

2 I_{max} : 150 mA (DC-PNP), 150 mA (AC/DC)

T_a Ambient temperature

T_p Process temperature

12.3 Process

NOTICE

► Note the pressure and temperature derating depending on the process connection selected.

Process temperature range	-40 to +100 °C (-40 to +212 °F) -40 to +150 °C (-40 to +302 °F)
Process pressure range	Max. -1 to +40 bar (-14.5 to +580 psi)
Density	> 0.7 g/cm ³ (optionally available: > 0.5 g/cm ³)
State of aggregation	Liquid
Viscosity	1 to 10 000 mPa·s dynamic viscosity
Solids contents	ø < 5 mm (0.2 in)
Lateral loading capacity	Lateral loading capacity of the tuning fork: max. 200 N



71578503

www.addresses.endress.com
